

UP

Universitatea
Politehnica
Timișoara

Research Report 2016

**Research
Annual
Report**

Politehnica
University
of Timisoara
2016

Research Report 2016

Research Report, 2016
The second edition of Research Report 2016, revised and expanded.

Copyright © Editura Politehnica 2016

All rights reserved to Politehnica University of Timisoara.
No part of this booklet may be reproduced or transmitted in any form or by any means, electronic or mechanical, including photocopy, recording, or any information storage and retrieval system now known or to be invented, without permission in writing from the publisher, except by a reviewer who wishes to quote brief passages in connection with a review written for inclusion in a magazine, newspaper, or broadcast.

Editorial team

Editor:
Assoc. Prof. Liviu Ioan CĂDARIU-BRĂILOIU, PhD

Co-Editors:
Agnes STEPANIAN, Ladislau WALKOVSKY, Andreia Claudia LĂZĂRESCU

Layout & cover design: Eugen STAN

Editura Politehnica
Bv. Republicii, nr. 9, 300159
Timișoara, România
Phone: +40 256 403823
Fax: +40 256 403021

ISSN 1841-2769

Research
Report 2016

**Research
Annual
Report**
Politehnica
University
of Timisoara
2016

Structure of the report

Introducing the Report	5
Research Centers	9
Scientific Excellence Awards	15
Projects supported by public funds	39
National Research Projects	41
International Research Projects	119
Projects supported by private funds	141
Patents	159
Granted Patents	163
Utility Models	169
Honorary Members	173
Doctor Honoris Causa	177
Habilitation Thesis	179
PhD Thesis	199
Scientific Conferences	207
Scientific Journals	215
ISI Papers	221
ISI Papers in highlight	225
Papers in ISI Journals	233
Papers in ISI Proceedings	249
Books	285
Books in highlight	289
Books List	293
Book Chapters List	299

Introducing the Report

“It’s not the walls that make a school, but the spirit living inside.”
King Ferdinand I, 1923

The needs for a modern society, in the context of a competitive global market, require highly skilled human resource development. In this context, the role of universities in the innovation process has increased continuously over time because the development of new products or technologies depends more and more on the findings of scientific research.

Established in 1920, shortly after the union of Romanian territories, in a European context marked by the redefinition of states and by the aftermath of World War I, the Polytechnic School in Timisoara – as it was originally called – was the answer to one of the requirements of the Romanian society of the time, namely the formation of engineers.

The mission of the Politehnica University of Timisoara is to offer nationally competitive and internationally recognized opportunities for Learning, Research, and Innovation at the highest levels of excellence. As a resource of knowledge for the public, the university builds partnerships with other educational institutions, community organizations, government agencies, and the private sector to fulfill the requirements for competences of the societal environment through superior professional training for students and graduates.

The present Research Report of Politehnica University of Timisoara gathers the main results obtained through the research activities carried out within the university in 2016, Politehnica being renowned as a remarkable actor on the stage of scientific research, both at national and international level. Our research activity is facilitated by the existence of twenty-six research centres specialized in fields that are capital for the sustainable development of any modern society. Each of these research centres brings together various prestigious researchers, whom, by their effort and vision, provide PUT with the incentives needed to contribute to the progress of our society.

Most of the research activity carried out by our institution is financed through external sources, obtained either from national and international calls for projects, or through agreements with private companies. This represents a confirmation of the superior quality of the research, but also of the prestige and professional deontology of the researchers affiliated to our institution. Politehnica’s reputation as an institution of advanced research is also emphasized by the patents obtained by its researchers, by the medals and prizes obtained in both national and international competitions, and by the collaborations with important research centres and institutes from Romania and from abroad.

Each year we select the most talented young researchers for our doctoral school, providing them with the opportunity to transform their knowledge and ideas into the innovations of tomorrow. Many of them take part in peer learning programs and consolidate in this way the relationship between our university and similar partner institutions. They strive for becoming doctors in science.

This report is divided into twelve sections, each one presenting a specific component of the research activity performed within the institution.

The first section focuses on the research infrastructure, which comprises the twenty-six research centres hosted by the university. The order in which they are presented is given by the research fields. The research centres, respectively teams of researchers, on different themes, are highly important for our university since they manage to put into practice the scientific research strategy of the university successfully, within the framework of numerous grants and contracts won by competition. The research results are materialized in papers, patents and products, all bringing for the University prestige, as well as important funds.

Research Report 2016

The second section of the Research Report is dedicated to the Scientific Excellence Awards. These prestigious awards celebrate those colleagues who have made a significant contribution in their field of research and continue to inspire future generations to get involved in science.

The third and fourth sections include the research projects implemented by the university. The third section includes the projects supported by public funds, both national and international, while the fourth one includes the projects supported by private funds awarded by companies. For the purposes of this report, we have chosen the most relevant projects for our the most representative projects for our research strategy.

The innovative capacity of the Politehnica University of Timisoara is supported by teachers and scientific researchers through patents and utility models invented, presented in the fifth section.

Politehnica University of Timisoara recognizes scientific excellence by conferring the honorary degrees of Doctor Honoris Causa and Honorary Professor to distinguished Researchers for their contribution to the development of PUT of continuous support, as shown in section six of this Report.

Sections seven and eight include habilitation theses and PhD theses held in 2016 in our University.

Section nine presents an overview of the most relevant scientific conferences that brought together scholars and professionals from Romania and from abroad. The conferences hosted by our university encouraged the dialogue, facilitated the exchange of ideas, and offered a great opportunity for new collaborations.

The tenth section gathers the scientific journals that have been published by our institution. This category includes journals specialized in various fields, such as computer science, chemistry and environmental engineering, electronics and communications, economics and social sciences, electrical engineering, mathematics and physics, hydrotechnics, physical education and sport, modern languages, etc.

The dissemination of the research results and findings is an integral part of the research process and the career in academia. Section eleven presents the most relevant scientific researches that have been published in 2016. It comprises the results obtained by our researchers, namely the papers that obtained recognition from some of the most prestigious journals, from both Romania and abroad.

And finally the twelfth section comprises a collection of books written by our researchers, most of them published under Politehnica Publishing House.

Through research we generate ideas, through ideas we generate innovation and through innovation we contribute to the improvement of the quality of life; this is why research is our priority.

RESEARCH CENTRES



Research Institute for Renewable Energy

Director: prof. Viorel UNGUREANU
Contact: viorel.ungureanu@upt.ro, www.icer.ro



Research Centre for Computers and Information Technology

Director: prof. Vladimir-Ioan CREȚU
Contact: vladimir.cretu@upt.ro, http://www.cs.upt.ro/~vcretu



Research Centre for Automatic Systems Engineering

Director: prof. Radu-Emil PRECUP
Contact: radu.precup@upt.ro, http://www.aut.upt.ro/centru-cercetare



Research Centre for Power Systems Analysis and Optimization

Director: prof. Ștefan KILYENI
Contact: stefan.kilyeni@upt.ro, http://www.et.upt.ro/index.php?sublink=1694&link=10&pag=2&lang=ro



Research Centre for Smart Energy Conversion and Storage

Director: prof. Nicolae MUNTEAN
Contact: nicolae.muntean@upt.ro,
http://www.et.upt.ro/index.php?link=10&sublink=1695&pag=1&lang=en



Research Centre for Intelligent Electronic Systems

Director: prof. Marius OTEȘTEANU
Contact: marius.otesteanu@upt.ro, http://www.ccesi.etc.upt.ro/index.php/ro



Research Centre for Intelligent Signal Processing

Director: prof. Alexandru ISAR
Contact: alexandru.isar@upt.ro, http://www.tc.etc.upt.ro/isprc



Research Centre for Multimedia

Director: prof. Radu VASIU
Contact: radu.vasiu@upt.ro, http://www.cm.upt.ro



Research Centre for Environmental Science and Engineering

Director: prof. Rodica PODE
Contact: rodica.pode@upt.ro,
http://www.chim.upt.ro/Facultatea-de-Chimie-Industriala-si-Ingineria-Mediului-Centru_GF.html



Research Centre for Inorganic Materials and Alternative Energies

Director: prof. Ioan LAZĂU

Contact: ioan.lazau@upt.ro,

http://www.chim.upt.ro/Facultatea-de-Chimie-Industrială-si-Ingineria-Mediului-Centru_Zx.html



Research Centre for Organic, Macromolecular and Natural Compounds' Chemistry and Engineering

Director: prof. Corneliu DAVIDESCU

Contact: corneliu.davidescu@upt.ro,

http://www.chim.upt.ro/Facultatea-de-Chimie-Industrială-si-Ingineria-Mediului-Centru_VT.html



Research Centre for Mechanics of Materials and Structural Safety

Director: prof. Dan DUBINĂ

Contact: dan.dubina@upt.ro, <http://www.ct.upt.ro/centre/cemsig/>



Research Centre for Hidrotechnical Engineering and Environmental Protection

Director: prof. Constantin FLORESCU

Contact: constantin.florescu@upt.ro, <http://www.ct.upt.ro/centre/cchpm.htm>



Research Centre for Building Services

Director: prof. Ioan BORZA

Contact: ioan.borza@upt.ro, <http://www.ct.upt.ro/centre/ccic/>



Research Centre for Retrofitting of Constructions

Director: prof. Valeriu STOIAN

Contact: valeriu.stoian@upt.ro, <http://www.ct.upt.ro/centre/reco.htm>



Research Centre in Infrastructures for Constructions and Transportation

Director: conf. Liviu Adrian CIUTINĂ

Contact: adrian.ciutina@upt.ro, <http://www.ct.upt.ro/centre/ict/index.htm>



Research Centre for Mechatronics and Robotics

Director: prof. Inocențiu MANIU

Contact: inocentiu.maniu@upt.ro, <http://mctr.mec.upt.ro/activitate-de-cercetare/ccmr/>



Research Centre for Medical Engineering

Director: prof. Liviu MARȘAVINA
Contact: liviu.marsavina@upt.ro, <http://cmpicsu.upt.ro>



Research Centre for Integrated Engineering

Director: prof. George DRĂGHICI
Contact: george.draghici@upt.ro, http://www.eng.upt.ro/imf/ccii/index_en.html



Research Centre for Processing and Characterization of Advanced Materials

Director: conf. Bogdan RADU
Contact: bogdan.radu@upt.ro, <http://eng.upt.ro/ccpcma>



Research Centre for Complex Fluid Systems Engineering

Director: prof. Romeo SUSAN-RESIGA
Contact: romeo.resiga@upt.ro, <http://mh.mec.upt.ro/cnisfc>



Research Centre for Thermal Machines and Equipments, Transportation and Environmental Pollution Control

Director: prof. Ioana IONEL
Contact: ioana.ionel@upt.ro, <http://mettcp.mec.upt.ro/>



Research Centre for Engineering and Management

Director: prof. Monica IZVERCIANU
Contact: monica.izvercianu@upt.ro, <http://www.mpt.upt.ro/pag/centru%20cercetare.html>



Research Centre for Urban Planning

Director: prof. Radu RADOSLAV
Contact: radu.radoslav@upt.ro, <http://ccddt.blogspot.ro>



Research Centre for Advanced Study Methods for Physical Phenomena

Director: prof. Dumitru TOADER
Contact: dumitru.toader@upt.ro, <http://www.et.upt.ro/etf/index.php?sublink=24&link=2&lang=ro>



Research Center for Materials and Industrial Technologies

Director: prof. Teodor HEPUȚ
Contact: teodor.heput@upt.ro, <http://www.fih.upt.ro/ccmti/>

SCIENTIFIC EXCELLENCE AWARDS

National Grand Lodge of Romania & Romanian Academy 2016 “Henri Coandă” Award for Applied Sciences Prof. Ion Gheorghe BOLDEA, PhD, New Member of the Romanian Academy

Acad. Ion Boldea, IEEE Life Fellow, University Politehnica Timisoara, Romania

Subject: 2016 “Henry Coanda Award” for applied sciences /by Romanian Academy and the Great National Masonic Loje

For the book : Ion Boldea : “Electric Generators handbook” vol. 1 + 2, 1000 pages, CRC Press Florida, Taylor and Francis Group, New York, second edition, 2016

The uni-author is still the single Monograph in English, in two volumes and 1000 pages on all electric modern electric generators, from topologies to modeling, performance transients to power electronics digital control, optimal design and testing. Electric generators convert mechanical energy in prime movers (turbines) into electric energy via a storage medium, magnetic energy.

Energy as the capacity of a system to produce mechanical useful work is together with Knowledge, the main two concepts that may describe all we humans do.

Electric energy by its flexibility in conversion, transport and utilization for motion and temperature control is the workhorse of all industries. Electric generators are used to “produce” all electric energy today with the exemption of Photovoltaic method (less than 0.5 %, still, but increasing); Electric generators are run by turbines whose mechanical energy is provided by fossil fuels or by river or wave water or wind energy; the latter is call “Renewable Energy” because it makes use of solar power beamed now on Earth at 1KW/m².

The Handbook treats all generators from those in wireless hotel door opener and cellular phone microphones to autonomous generators on vehicles and as auxiliary power sources for Telecom, hospitals, banks Data Centers and thermal or hydro or wind power plants (or parks), at powers from less than 1 W to 1800 MVA per unit

The Handbook presents a unitary view of electric generators with numerous results from literature and of the author’s over decades of experience in the field, with many numerical examples mainly for the young reader/researcher/inventor/designer in industry.



Thanks I am due with humility for this prestigious Award (Henry Coanda is a legendary Romanian creator in science). I am also conscious of the generous degree of luck and circumstance involved in such a process, and only hope that, by continuing the work humbly, with internationally visible results, in full honesty, compassion and joy, I may come closer to deserve it fully.

Sincerely, Ion Boldea
January, 2017.

National Grand Lodge of Romania & Romanian Academy 2016 "Spiru Haret" Award for Education, Environment and IT Prof. Radu-Emil PRECUP, PhD & Lect. Mircea-Bogdan RĂDAC, PhD

The Spiru Haret Award from the National Grand Lodge of Romania in partnership with the Romanian Academy for education, environment and IT has been awarded to Lect. Dr. Mircea-Bogdan RĂDAC and Prof. Radu-Emil PRECUP, with the Department of Automation and Applied Informatics, for the following group of papers published in 2015 and generically called Contributions to Model-Free Data-Driven Control:

- M.-B. Rădac, R.-E. Precup, Data-based two-degree-of-freedom iterative control approach to constrained non-linear systems, IET Control Theory & Applications, vol. 9, no. 7, pp. 1000-1010, 2015, impact factor = 2.048.
- M.-B. Rădac, R.-E. Precup, Optimal behaviour prediction using a primitive-based data-driven model-free iterative learning control approach, Computers in Industry, vol. 74, pp. 95-109, 2015, impact factor = 1.957.
- M.-B. Rădac, R.-E. Precup, E. M. Petriu, Model-free primitive-based iterative learning control approach to trajectory tracking of MIMO systems with experimental validation, IEEE Transactions on Neural Networks and Learning Systems, vol. 26, no. 11, pp. 2925-2938, 2015, impact factor = 4.854.
- M.-B. Rădac, R.-E. Precup, E. M. Petriu, Constrained data-driven model-free ilc-based reference input tuning algorithm, Acta Polytechnica Hungarica, vol. 12, no. 1, pp. 137-160, 2015, impact factor = 0.544.
- R.-C. Roman, M.-B. Rădac, R.-E. Precup, E. M. Petriu, Data-driven optimal model-free control of twin rotor aerodynamic systems, Proceedings of 2015 IEEE International Conference on Industrial Technology ICIT 2015, Seville, Spain, pp. 161-166, 2015.

This group of papers proposes learning approaches for automatic control systems in order to endow them with intelligent features such as learning, prediction and hierarchical control capabilities, which are specific to living organisms. This attempt should lead towards higher degrees of autonomy and adaptability in feedback control systems, enabling them able to deal with uncertainty, environment operational constraints, nonlinearities, scalability, large number of design variables. The research fits well within current

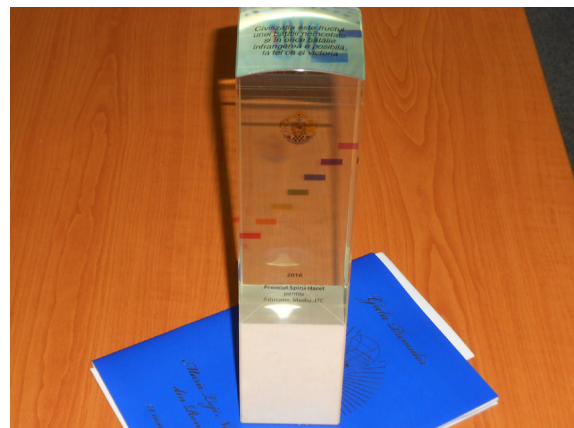

trends in control and artificial intelligence research topics such as autonomous self-driving vehicles, robots and unmanned aerial vehicles. The underlying idea borrows the ability of living organisms to learn, accumulate learning experience and extrapolate it optimally in new situations never seen before, while never explicitly solving mathematical equations for that, using the biological brain as a hierarchical high-level controller that coordinates the low level controllers. This has lead and motivated the development of the model-free data-driven techniques proposed by the authors.

Romanian Academy 2016 “Constantin Budeanu” Award Prof. Lucian Nicolae TUTELEA, PhD & Assoc. Prof. Sorin Ioan DEACONU, PhD

The actual e - continuously variable transmission (e-CVT) solution for the parallel Hybrid Electric Vehicle (HEV) requires two electric machines, two inverters, and a planetary gear. A distinct electric generator and a propulsion electric motor, both with full power converters, are typical for a series HEV.

This book introduces a novel brushless, single winding and single stator, dual PM rotor axial-air-gap machine capable to deliver independently torque at the two rotors by adequate vector control. It is presented the preliminary designing with Matlab, quasi 3D and 3D FEM analysis and validation, the optimal design via Hooke Jeeves method and control of a synchronous machine with axial airgap single stator dual-rotor with permanent surface magnets and different pole pairs number, destined for hybrid electric vehicles (HEV) applications. For machine’s designing was used the equivalent magnetic circuits method that takes into account the saturation and dispersion of the magnetic field.

Lucian Nicolae Tutelea is professor at the Politehnica University of Timisoara, Romania, PhD coordinator in electrical engineering, member of IEEE since 2007, qualified in the field of optimal design of electrical machines, digital control of electrical drives, loading the artificial load of the induction machine, modeling and simulation of electrical drives using the languages C and Matlab, finite element analysis of electric machines with 30 articles in ISI conferences and journals, 6 participations in research projects (since 1997) as a director or as a team member in the field of electrical machines, power electronics, electric drives systems in vehicles, renewable energy systems and electric drives (of which 1 is a FP7 project).

Sorin Ioan Deaconu is associate professor at the Politehnica University of Timisoara, Romania, member of IEEE since 2006, the main author and/or co-author of more than 100 international paper, 42 ISI articles and 38 DBI, the main author and/or co-author of 20 books and member at 10 national grants team. Associate editor at “Journal of Electrical Engineering” from 2015 and reviewer at more than 75 ISI and 400 BDI articles (journals and conferences).

Since 1994, he had collaborated with BeeSpeed Automation Ltd, Timișoara, where he was involved in several industry projects regarding industrial automation, electric machines and drives in many company in the western of Romania.

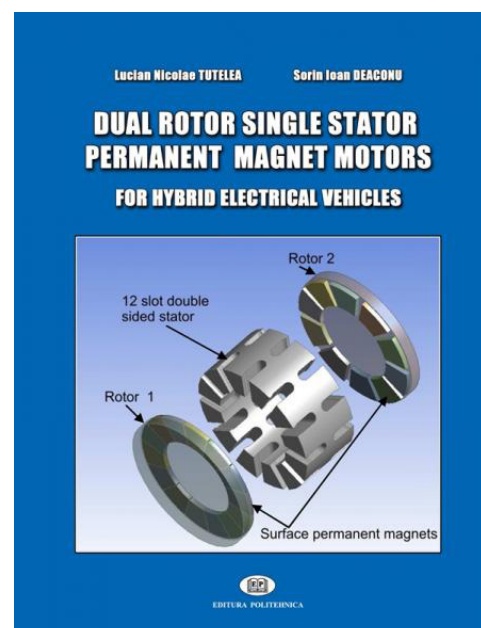

The book was conceived primarily as a technical support for electrical engineers in hybrid and electrical vehicles design and production, but it is expected to be of interest and useful for students and staff members of electrical engineering faculties, as well as, for engineers working in automotive industry.

Romanian Academy 2016 “Gheorghe Ionescu Sișești” Award Professor emeritus Eugen Teodor MAN, PhD

DRAINAGE vol. I and II,
Publisher “Horizons University” of Timisoara, 2014,
ISBN 978-973-638-565-0
Vol.I -2014-Bibliogr.-ISBN978-973-638-566-7;
Vol.II -2014-Bibliogr.-ISBN978-973-638-567-4
Author : Prof.univ.emerit dr.eng. Man Teodor Eugen

The present work was constructed as a monograph focused on issues concerning drainage, summarizing knowledge on agricultural drainage regarding: the worldwide history of land drainage, evolution and dynamics of land drainage in Romania, computing / dimensioning / design problems, construction, operation and maintenance of drainage arrangements, measuring flows in drainage arrangements as well as the results of studies and researches conducted over the past 40 years in this area, by the author, together with the research team at the “Politehnica” University of Timisoara, Faculty of Civil Engineering, respectively Faculty of Hydrotechnics (1990-2011), in the Department of Hydraulic Structures and Land Improvement, Department of Hydrotechnics (2011-2014), from the '70s to the present.



The book “Drainage” Vol I and II (957 pages), Ed “Horizons University” Timisoara 2014 he won “Gheorghe Ionescu Sișești” awarded by the ROMANIAN ACADEMY in 2016 and the prize “Ion M. Gheorghiu” awarded by the ACADEMY OF AGRICULTURAL AND FORESTRY BUCHAREST 2015 .

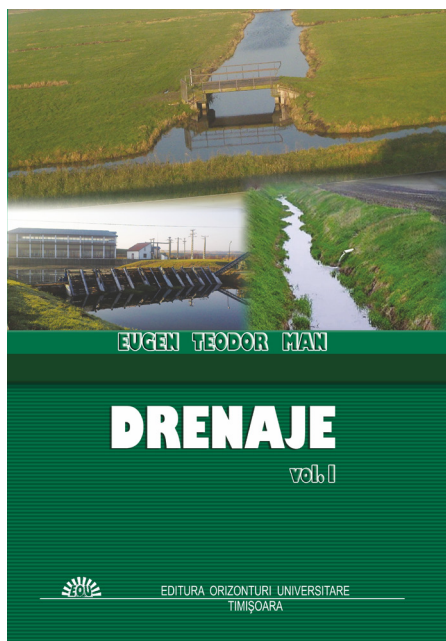

Romanian Academy 2016 “Grigore Moisil” Award Radu-Emil PRECUP, Radu-Codruț DAVID, Ștefan PREITL & Mircea-Bogdan RĂDAC

The “Grigore Moisil” Prize from the Romanian Academy has been awarded to Prof. Radu-Emil PRECUP (Department of Automation and Applied Informatics (DAAI)), Dr. Radu-Codrut DAVID (Sustainalytics), Prof. Emil M. PETRIU (University of Ottawa, Canada), Prof. Stefan PREITL (DAAI) and Lect. Dr. Mircea-Bogdan RĂDAC (DAAI), for the following group of papers published in 2014 and generically called Optimization of fuzzy systems:

- R.-E. Precup, R.-C. David, E. M. Petriu, M.-B. Rădac, S. Preitl, Adaptive GSA-based optimal tuning of PI controlled servo systems with reduced process parametric sensitivity, robust stability and controller robustness, IEEE Transactions on Cybernetics, vol. 44, no. 11, pp. 1997-2009, 2014, impact factor = 4.943.
- R.-E. Precup, R.-C. David, E. M. Petriu, S. Preitl, M.-B. Rădac, Novel adaptive charged system search algorithm for optimal tuning of fuzzy controllers, Expert Systems with Applications, vol. 41, no. 4, part 1, pp. 1168-1175, 2014, impact factor = 2.981.
- R.-C. David, R.-E. Precup, E. M. Petriu, S. Preitl, M.-B. Rădac, L.-O. Fedorovici, Adaptive evolutionary optimization algorithms for simple fuzzy controller tuning dedicated to servo systems, in: Fuzzy Modeling and Control: Theory and Applications, F. Matia, G. N. Marichal and E. Jimenez, Eds., Atlantis Computational Intelligence Systems, vol. 9 (Atlantis Press and Springer-Verlag), pp. 159-173, 2014.

The awarded group of papers proposes nature-inspired evolutionary-based optimization algorithms. These algorithms are applied to the optimal tuning of fuzzy controllers for a class of nonlinear servo systems. Fuzzy control systems with a reduced parametric sensitivity are obtained. This can be of large importance for many fuzzy logic, control, modeling, optimization and expert systems applications, as they are also applied to the optimal tuning of fuzzy models that characterize the nonlinear dynamics specific to processes in technical and non-technical fields. These papers are a product of the joint cooperation between two universities, and a part of this cooperation is supported by research contracts. These papers are highly appreciated and cited by specialists who actively work in automatic control, optimization and systems modeling.



Romanian Academy 2016 “Tudor Tănăsescu” Award Prof. Gheorghe-Daniel ANDREESCU, PhD

The Tudor Tănăsescu award of the Romanian Academy is an annual prize for Excellency in research with publications and citations inside the field of the Information Science and Technology section.

Prof. Gheorghe-Daniel Andreescu is the recipient of this award in December 2016 for original research contributions in four scientific papers in the area of advanced automation.

Short biography

Gheorghe-Daniel Andreescu received the diplomat engineer degree in Applied electronics in 1977 and the PhD degree in Automatic systems (System engineering) in 1999 from the Politehnica University of Timișoara (UPT). He is currently a Professor at the Department of Automation and Applied Informatics in UPT since 2004, PhD adviser in System engineering since 2005, and director of the UPT Doctoral School of Engineering Studies since 2012.

His main research field of interest include: advanced control of ac drives, sensorless control, observers, sliding-mode control, power electronics control, mechatronic systems, greenhouse climate control, modelling and simulation of hearing with cochlear implants, drum boiler-turbine control, real-time implementations.

Prof. Andreescu is author or co-author of more than 90 papers in international conference proceedings and international journals, with 16 journal papers indexed in Web of Science including IEEE Transactions on: Industrial Electronics (2), Industry Applications (3), Energy Conversion (2), Power Electronics (2); IET Electric Power Applications (3), Electric Power Components and Systems (3) with an average impact factor $IF = 2.56$. He is a Senior Member of IEEE since 2005.

His papers have more than 1100 independent citations from indexed papers, including more than 600 citations in Web of Science (300 in journals with a cumulative impact factor $IF = 890$ and average $IF = 2.9$), with citations of more than 40 US/EU patents and 80 PhD/MS thesis abroad. His Hirsh index in Web of Science is 11, and in Scopus is 17. Citations include authors from more than 100 universities (20%) in Top 500 World Universities. Prof. Andreescu has been nominated by Thomson Reuters as a Highly Cited Researcher in 2016.

Original contributions in 2014 - papers and citations

For the 2014 year, Prof. Andreescu has more than 60 citations in Web of Science Thomson Reuters.

There are four papers in 2014 with original contributions taking into account for Romanian Academy award, where Prof. Andreescu is coauthor in three different domains of advances automation as following:

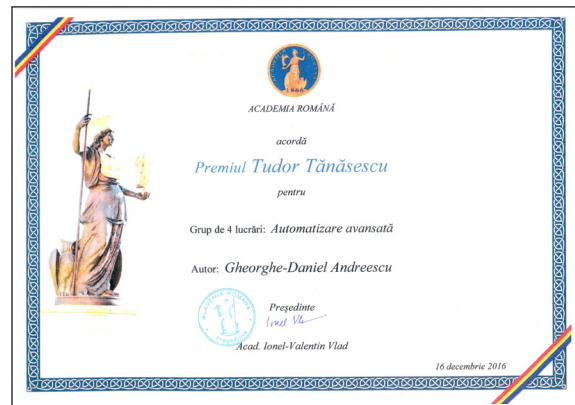

A) Advanced sensorless control systems for ac electric drives:

[1] M.C. Ancuti, L. Tutelea, G.-D. Andreescu, F. Blaabjerg, C. Lascu, I. Boldea, Practical wide-speed-range sensorless control system for permanent magnet reluctance synchronous motor drives via active flux model, *Electric Power Components and Systems*, 42(1): 91-102, Jan. 2014.

B) Greenhouse climate control systems:

[2] E.H. Gurban, T.-L. Dragomir, G.-D. Andreescu, Greenhouse climate control enhancement by using genetic algorithms, *Control Engineering and Applied Informatics*, 16(3): 35-45, Sep. 2014.

[3] E.H. Gurban, G.-D. Andreescu, Comparison of modified Smith predictor and PID controller tuned by genetic algorithms for greenhouse climate control, *Proc. IEEE 9th International Symp. on Applied Computational Intelligence and Informatics*, pp. 79-83, May 2014.

C) Modelling and simulation of hearing with cochlear implants with novel auralization method:

[4] A.M. Kuczapski, G.-D. Andreescu, Modelling and simulation of hearing with cochlear implants: A proposed method for better auralization, *Proc. 6th International Workshop Soft Computing Applications (SOFA 2014)*, and in *Soft Computing Applications, Vol. 357 series Advances in Intelligent Systems and Computing*, Springer, pp. 753-767, 2015.

Again, I would like to thank to my co-authors for the beautiful working together with the main results given by the above papers. From Politehnica University of Timisoara - greatly thanks to my excellent PhD students E.G. Gurban and A.M. Kuczapski, special thanks to prof. T.L. Dragomir and highly considerations and gratitude to prof. Ion Boldea with his team M.C. Ancuti, L. Tutelea, C. Lascu, and many thanks to prof. F. Blaabjerg from Aalborg University, Denmark.

International Exhibition of Inventions of Geneva 2016 Gold Medal and “Best Invention Award” Special Prize Corneliu BIRTOK-BĂNEASĂ, PhD Student

The International Exhibition of Inventions of Geneva 13-17 April 2016 played host to over 1,000 inventions from 40 countries were presented to more than 70,000 visitors.

I presented at last year’s Salon a device called ‘Integrated heat deflector’ used on vehicles during summer to combat the engine’s power loss due to high external temperatures. The integrated heat deflector addresses this technical problem by protecting the intake manifold and air filter from the thermal radiations generated by the cooling radiator of internal combustion engines, which optimizes its operation during very hot days; it decreases the fuel consumption by up to seven percent.

The jury acknowledged that by implementing this invention the fuel consumption goes down, and the device contributes to a diminishing of the pollutants emitted into the atmosphere by the vehicles where it might be used; that it is a patented innovation; and not least that it is part of a UPT doctoral study.

The international jury rewarded the invention with a gold medal and a “Best Invention Award” special prize on behalf of Science & Technology Parks Corporation from Hong Kong.

Results / portfolio

33 Gold Medals: INVENTIKA 2008; BRUSSELS 2008, INVENTIKA 2009; GENEVA 2010; INVENTICA 2010; MOSCOW 2010; ZAGREB 2010; KUWAIT 2010; INVENTICA 2011; PROINVENT 2012; GENEVA 2012; BRUSSELS 2012; GENEVA 2013; BRUSSELS 2013; GENEVA 2014; PROINVENT 2015; GENEVA 2015; TRAIAN VUIA 2015; INVENT INVEST IASI 2015; BRUSSELS 2015; PROINVENT 2016; GENEVA 2016; EUROINVENT 2016; TRAIAN VUIA 2016.

6 Silver Medals: GENEVA 2009; MOSCOW 2009; BRUSSELS 2009; TRAIAN VUIA 2015; ARCA 2015; INVENT INVEST IASI 2015.

2 Bronze Medals: ZAGREB 2009; GENEVA 2011.

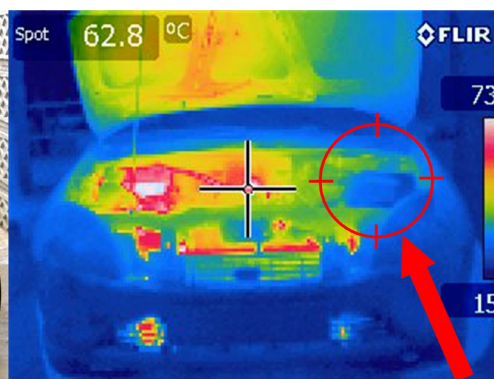
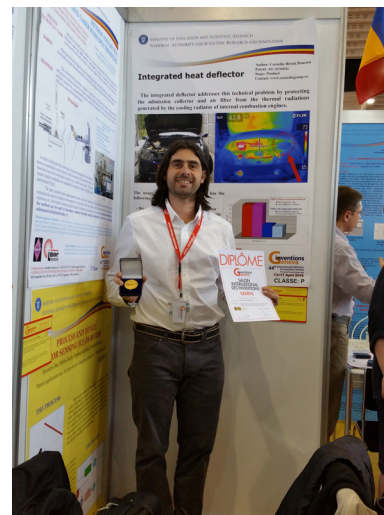

Research Report 2016

Bruxelles INNOVA 2016 Fair

Gold medal with mention alongside a diploma with honors

Ștefan PAVEL, Ancuța Letiția TUTELCA, Deian Adrian JIFCU, Eugen Florin LĂCĂTUȘU, Andrei ADAM, Cristina VLAD DALIBORCA, Victor DUMITRESCU, Elena HOGEA, Iconia Ecaterina BÔRZA & Silviu Cristian SUCIU

In november 2016, POLITEHNICA University of Timișoara was been selected to participate at Bruxelles INNOVA 2016 Fair. In the romanian stand, under the aegis of ANCSI (National Authority for Scientific Research and Innovation), it was exhibited the invention ELECTRIC INSTALATION FOR DENTAL MEDICAL UNITS AIR DISINFECTION, appreciated by a large number of visitors and awarded, by 6 international examiners, with a diploma and gold medal with honors alongside a diploma with honors and a medal from HALLER foundation – Proinventio/Poland.



Springer & Environmental Monitoring and Assessment 2016 Certificate of Excellence in Reviewing Prof. Ioana IONEL, PhD

In academic publishing, the goal of the review is to assess the quality of articles submitted for publication.

Peer review has been a formal part of scientific communication since the first scientific journals appeared more than 300 years ago. The Philosophical Transactions of the Royal Society is thought to be the first journal to formalize the peer review process [<https://www.elsevier.com/reviewers/what-is-peer-review>].

Professional peer review focuses on the performance of professionals, with a view to improving quality, upholding standards, or providing certification. In academia, peer review is common in decisions related to faculty advancement and tenure [https://en.wikipedia.org/wiki/Peer_review].

By receiving this award I really felt honored, especially because my registration as reviewer attests directly the fact that the Romanians can assist and support maturity and continuity of an excellent and valuable per review journal. Going back, I cannot remember when I started to dedicate time for reviewing. First it was interest, then a pleasure, and finally I found out that it is a necessity for a teacher that must face the continuous struggle to turn every lecture, in the era of progress and internet, into an attractive one, accounting also for the recent developments in the field. The second necessity grows from the need of improving not only my knowledge, but also the technique and methods of writing, explaining and judging.

I feel very content when my advice is accepted partially or totally, or even not, but it is taken into account and debated! The chance is offered frequently as per reviewer, in a group of experts. Initially you get training, mostly on line, subject to different situations and steps to follow. The review process is single, double or direct peer review, most recently the more transparent peer review was introduced.

Generally, after all reviewers express their recommendations (according to special asked questions and as well opinions, focusing on real aspects) and decisions, the corresponding author are posting a revised version, and the second or even third stage of review occurs, by the same or different specialists, depending on options expressed individually. It is really a success when a statistic is realized from time to time by the editor and you realize that you had also a contribution to the scientific paper, in its accepted form.

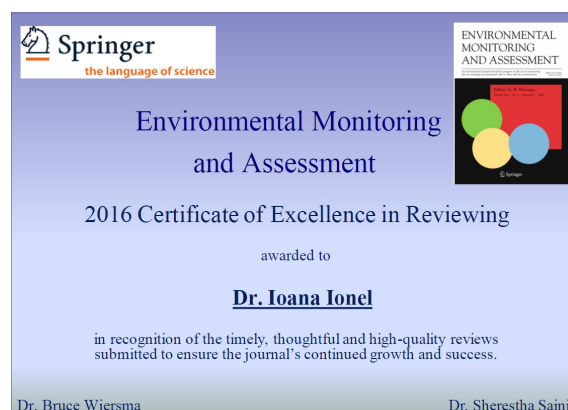
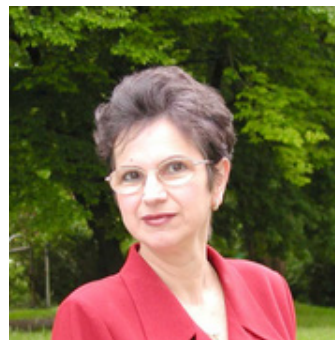

Ethics, impartiality, accuracy, power of decision and validation, recognition of work, reasonable and constructive criticism, power of evaluating, concentration are basics for a friendly and successful blind review.

The received certificate denotes that the Politehnica University of Timisoara contributes, through its staff, both to the development of science and supports progress and quality in science.

International Journal Fatigue & Fracture of Engineering Materials & Structures Top Reviewer Award Prof. Liviu MARŞAVINA, PhD

In 2016 Prof. Dr. Eng. Liviu MARŞAVINA from University Politehnica Timişoara received the Best Reviewer award for International Journal Fatigue & Fracture of Engineering Materials & Structures (Impact factor 1.838 in 2015), edited by John Wiley & Sons Ltd. As a consequence Prof. Marsavina was nominated in the Editorial Board of the Journal starting from 2017.



General Association of Engineers in Romania - A.G.I.R. A.G.I.R. 2015 Award to the category "Applied Sciences" Prof. Vasile MARINCA, PhD & Prof. Nicolae HERIȘANU, PhD

The A.G.I.R. 2015 Award - for the book:
Marinca V., Herisanu N., THE OPTIMAL HOMOTOPY ASYMPTOTIC METHOD. ENGINEERING APPLICATIONS
SPRINGER International Publishing AG Switzerland, 2015, ISBN 978-3-319-15373-5

Since 1995, the AGIR Award is awarded yearly, for the previous year, to the most valuable engineering works or original published works with high scientific level. On September 16, 2016 prof. V. Marinca and prof. N. Herisanu received this award to the category "Applied Sciences" for their book published by Springer in 2015.

This is a reference book with an essential contribution to the development of the field of "Engineering Science" and it is primarily intended to researchers, academics, professional engineers and PhD students working in different engineering branches.

The subject approached by the authors in this book is related to analytical investigation of nonlinear dynamical systems. The authors proposed an original method, which already produced a good impact in the scientific world, judging upon the numerous papers published based on this method by many researchers worldwide.

The entirely book relies on the original research results obtained by the authors in the field of nonlinear dynamical systems and represents a continuation of their first book published by Springer in 2011 - "Nonlinear Dynamical Systems in Engineering. Some Approximate Approches", ISBN 978-3-642-22735-6.

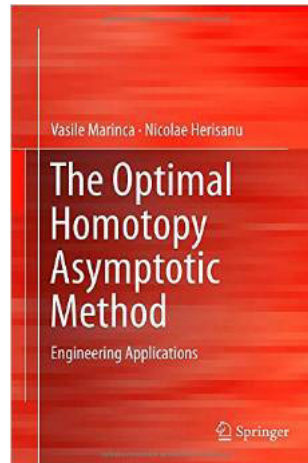

The book emphasizes the applicability of the OHAM to various models selected from various engineering fields such as vibration, classical and fluid mechanics, electrical machines, thermodynamics, physics, and so on.

The analytical solution of such dynamical systems are optimized through rigorous and efficient procedures using computer programs so that always a very good accuracy is ensured even for strong nonlinearities.

It is to remark that according to WorldCat database www.worldcat.org, the book is already present in 201 libraries worldwide, including some of the most important top universities of the world such as Stanford University and Massachusetts Institute of Technology (MIT). The awarding ceremony took place on September 16, 2016 at the headquarters of AGIR from Calea Victoriei 118, Bucharest.



BANAT EXCELLENCE GALA - 3rd Edition, 2016 "Traian Vuia" Award for Engineering Sciences Professor emeritus Alexandru NICHICI, PhD

Banat Excellence Gala is organized annually by the Romanian Academy - Timisoara Branch, State Universities of Timisoara and National Grand Lodge of Romania. On the occasion, they were awarded personalities of the academic environment of Banat from different fields of science, as natural science, social science, engineering, humanities, biological science, agronomy and civic involvement.

At the 3rd Edition of Banat Excellence Gala, at 23 november 2016, Professor Alexandru Nichici has received "Traian Vuia" Award for "Engineering Sciences" as recognition of its excellence in academic, scientific and managerial lifetime activities and achievements. The Award Jury also appreciated the dignity and academic ethics consistently promoted by Professor Alexandru Nichici.

Alexandru Nichici is an emeritus professor of the POLITEHNICA University of Timisoara, Romania.

Alexandru Nichici - Biographical Summary

Professor Alexandru Nichici was born on May 29, 1935 in the village Ivanda, Timis County, Romania. In 1958, he graduated Polytechnic Institute of Timisoara, Faculty of Electrical Engineering. He received his PhD in 1970, after defending the PhD thesis: "Fundamental Phenomena in electro-discharge machining of metallic materials". Since 1971, Alexandru Nichici became assistant professor and since 1980 – university professor at The Materials Technology Department, Mechanical Faculty, Polytechnic Institute of Timisoara. In 1974-1976 periods he taught at the National University of the Republic of Zaire. Since 1990 he became PhD director in the domain of Materials technology. After official retirement in 2000, professor Alexandru Nichici coordinated and taught basic courses in an advanced training program for doctoral students of Timisoara Politehnica University (2008-2011). In 2014, he was awarded with the Professor Emeritus degree. In the management of the University Politehnica Timisoara, Professor Alexandru Nichici exercised the functions of Vice - Dean of the Mechanical Faculty (1977-1982), Head of the Department of Mechanical Technology (1985-1990), Rector of the Politehnica University (1992-1996) and scientific secretary of the University Senate (1996-2000).



COMMUNICATION SKILLS: French, English, Russian, Serbian, Romanian; ACADEMIC AND SCIENTIFIC DOMAINS OF COMPETENCE: Material Science and technology; Systems and technologies for materials processing by electrical erosion and laser, Experiments design, Universities management; PROFESSIONAL ASSOCIATIONS: General Association of Engineers in Romania, The Society of Photo-Optical Engineers, Alliance of Universities for Democracy; PUBLICATIONS: numerous scientific papers, textbooks and some original scientific and academic books, as: Prelucrarea prin eroziune în construcția de mașini, Editura Facla, 1983; Formarea profesională în inginerie. Ieri, azi, mâine. Eseuri., Editura „Politehnica”, 2004; Lucrări științifice- concepere, redactare, comunicare, Editura „Politehnica”, 2008, 2010; Șansă și determinare (memorialistică), Editura „Politehnica”, 2014.



American Romanian Academy of Arts and Sciences Young Scientist Poster Award in Railway History Assist. Prof. Ramon Mihai BALOGH, PhD

Brief history of American Romanian Academy of Arts and Sciences

ARA is an internationally nonprofit organization recognized academic organization that supports multidisciplinary studies and achievements in exact and natural sciences, mathematics, also linked with arts, linguistics, literature, political studies and sociology. The main goal is to foster cultural exchanges between the American and Romanian cultures, and it is based mainly on its members' activity, having a Romanian origin or sympathizing with them. ARA was founded in California in 1975 by a group of American-Romanians, and by 2016 it has of about 63 Honorary Members, 80 Full Members, 80 Corresponding Members and 7 Benefactors. Their valuable support is a great asset for ARA. Since 1975, ARA has had Honorary members amongst very well known personalities like: the writers Eugen Ionesco and Virgil Gheorghiu, the philosopher Mircea Eliade or presentely the Nobel Prize in physiology or medicine, Prof. George E. Palade and the Romanian astronaut Dr. Dumitru-Dorin Prunariu. Some of the invaluable members have passed away but the legacy they left is still alive and cherished by ARA, its members, their families, and all of their friends. The Romanian branch of ARA has its center in Timișoara, being closely coordinated with the US main organization.

ARA organizes and sponsors conferences, annual congresses, organizes research projects, and publishes its own peer-reviewed international journal under the title Journal of the American Romanian Academy of Arts and Sciences, and the ARA Newsletter for its membership. The highlight of the annual congress is its Proceedings which is published on an annual basis. Also organizes educational courses at various times in specific areas such as, for example: Mathematics, Fluid Mechanics, Economics, Romanian and American History, Comparative History of Religions, Romanian Folklore and American Literature correlates, Aesthetics, Folk Dancing, Folklore Quilting and Paintings. The engineering and computing courses organized in collaboration with the Romanian Branch of ARA in Timișoara are especially popular, and attracted large audiences of both students and faculty.



I took the opportunity, after I received my PhD title and gained experience in my field of activity to get more close contact to prominent thinkers of Romanian descent, as well as thinkers of demonstrated interest in the Romanian contributions to the advancement of arts and sciences, and thus I sent a proposal to the 40-th ARA congress, organized in 2016, Montreal, Canada, July 28-31. I feel very sad seeing the present situation of the Romanian railway, and felt that I should present, with my humble possibilities, that Romania, especially Banat, can be considered pioneer in railway applications, roads and construction, monumental achievements from which only the history is mentioning it. The Banat region, situated at the geographic crossroads between Eastern and Western Europe, with a special history and a destiny often broken by the vicissitudes of time, is known for many primordialities, all certified without denial. One of them is the first railway track on the present territory of Romania, that proofs the development and entrepreneurial spirit of the Bant inhabitants. Thus I wrote the paper Looking through the curtain of history, having as coauthors Dr. Dan S. STEPAN and Professor Ioana IONEL, that encouraged and supported me a lot. The surprise was that the paper was awarded with a special prize, and I feel proud of the fact that it was achieved in such a creative and precious atmosphere of the ARA conference.
<http://www.americanromanianacademy.org/2016-ara-awards>.

7 Medals at European Exhibition of Creativity and Innovation - EUROINVENT Award for the Best Fabrication Pending and Gold Medal at INVENT - INVEST 2016

POLITEHNICA University of Timișoara took part to the 8th edition of the European Exhibition of Creativity and Innovation - **EUROINVENT** held in Iași, Atrium Palas Mall, 19-21 may 2016, organised by Romanian Inventors Forum, „Gheorghe Asachi” Technical University, „Europe direct” Association for Ecology and Sustainable Development Iași and „Al. I. Cuza” University, under the aegis of IFIA – International Federation of Inventors’ Associations and WIIPA – World Invention Intellectual Property Associations.

There were 560 inventions and research themes from 43 countries.

POLITEHNICA University of Timișoara exhibited a number of 6 inventions with prototypes:

◇ WASTE WATER DECONTAMINATION SYSTEM IN THE DENTAL UNIT – **Ștefan PAVEL**, Prof. **Ioan BORZA**

◇ LIGHTING SYSTEM FOR THE „CERAMIC ROOM” COMPARTMENT OF THE DENTAL LABORATORIES – **Ștefan PAVEL**, Prof. **Ioan BORZA**

◇ COMPRESSED AIR SYSTEM FOR DENTAL UNITS – **Ștefan PAVEL**, Prof. **Ioan BORZA**

◇ ELECTRIC INSTALATION FOR DENTAL MEDICAL UNITS AIR DISINFECTION – **Ștefan PAVEL**, Prof. **Ioan BORZA**

◇ PORTABLE DEVICE FOR SIGNALING PAIN, SENSITIVITY OR DISCOMFORT DURING THE COURSE OF MEDICAL DENTAL ACTIVITY – **Ștefan PAVEL**, **Silviu-Cristian SUCIU**

◇ PORTABLE DEVICE FOR AIR AND SURFACES DISINFECTION IN ENCLOSED ENVIRONMENTS – **Ștefan PAVEL**, **Silviu-Cristian SUCIU**

The inventions were appreciated by the visitors and the international jury (Honorary president Kane **KRAMER** – British Inventors Society (United Kingdom), President Mohd Mustafa Al **BAKRI ABDULLAH** – Universiti Malaysia Perlis (Malaysia), Vice-president Alireza **RASTEGAR** – International Federation of Inventors’ Association (IFIA), Vice-president, Ljiljana **PEDISIC** – Croatian Inventors Association (Croatia)) assessed and awarded them with 7 medals, 4 gold and 3 silver.

POLITEHNICA University Timișoara took part to the 7th edition of “**INVENT - INVEST 2016**” Inventions and Practical Ideas – International Fair held in Iași at Palatul Culturii-Complexul Muzeal Național „Moldova”, organised by Romanian Inventors Society and “Gheorghe Asachi” Technical University, an international scientific event intended for research results and technical creativity promotion, alongside a connection possibility between inventors and researchers with investors.

Beside the former 6 inventions, awarded at the previous event held in Iași between 19-21 2016, POLITEHNICA University of Timișoara exhibited the invention **MOBILE DEVICE FOR INFANT SUPPORT DURING PAEDIATRIC RADIOLOGY** (**Ștefan PAVEL**, **Călin Marius POPOIU**), awarded with “**AWARD FOR THE BEST FABRICATION PENDING**” and gold medal.

Other prototypes, showed in posters and short footage at the UPT stand, were valued by 29 visitors and also assessed and awarded by an international jury with 4 gold medals and diploma of excellence and 3 Fair medals with diploma (**Ștefan PAVEL**, **Silviu-Cristian SUCIU**, **Ancuța Letiția TUTELCA**, Prof. **Ioan BORZA**).



MakeLearn and TIIM 2016 Joint International Conference, Timișoara, Romania

BEST PAPER AWARDS

Assoc. Prof. Claudiu Tiberiu ALBULESCU, PhD & Assist. Prof. Șerban MICLEA, PhD

BEST PAPER AWARDS at MakeLearn and TIIM Joint International Conference, Timisoara, Romania

Conference aims:

- MakeLearn & TIIM 2016 conference theme focuses on Managing Innovation and Diversity in Knowledge Society through Turbulent Time.
- Innovation has become management's new imperative and finding novel solutions to important problems is not only hard, but complex.
- Knowledge management can be the foundation in the search for the right answers and future directions in managing innovation and diversity in knowledge-based society.

The paper 'The interdependence between Italian firms' access to finance and their probability of default' received the "Best Paper Award" in the framework of the MakeLearn & TIIM 2016 conference, held in Timisoara on 25-27 May 2016.

In this work, the authors presented a part of their research results under the project "The impact of the economic and financial stability on investments, innovation process and entrepreneurial activity in the EU" (PN-II-RU-TE-2014-4-1760, UEFISCDI).

The authors are:

Claudiu Tiberiu ALBULESCU, Associate Professor, Department of Management, Politehnica University of Timisoara.

Research interests: Macroeconomics and monetary economics, Banking and financial markets, Energy economics and finance, Entrepreneurship and innovation, Small Business Economics

Șerban MICLEA, Assistant Professor, Department of Management, Politehnica University of Timisoara.

Research interests: Marketing and Management, Small Business Economics



EXECUTIVE UNIT FOR FINANCING HIGHER EDUCATION, RESEARCH, DEVELOPMENT AND INNOVATION - UEFISCDI AWARDS

Through these awards UEFISCDI aims to increase quality, impact and international visibility of Romanian research by recognizing and rewarding significant results published in prestigious journals from international senior scientific stream.

Within this competition can participate the researchers affiliated to institutions in Romania, authors of scientific articles published in journals indexed by Thomson Reuters Science Citation Index Expanded ("Science"), Social Sciences Citation Index ("Social Sciences") or Arts & Humanities Citation Index ("Arts & Humanities").

More information at <http://uefiscdi.gov.ro/Public/cat/471/Premierea-rezultatelor-cercetarii.html>

1. Craciunescu, C., Ercuta, A. Modulated interaction in double-layer shape memory-based micro-designed actuators, SCIENCE AND TECHNOLOGY OF ADVANCED MATERIALS, Volume: 16, Issue: 6, Article Number: 065003, ISSN: 1468-6996, eISSN: 1878-5514, 2015;
2. Dinu, F., Dubina, D., Marginean, I. Improving the structural robustness of multistory steelframe buildings, STRUCTURE AND INFRASTRUCTURE ENGINEERING, Volume: 11, Issue: 8, Pages: 1028-1041, ISSN: 15732479, eISSN: 17448980, 2015;
3. Grigorie, AC., Muntean, C., Stefanescu, M. Obtaining of gamma-Fe2O3 nanoparticles by thermal decomposition of polyethyleneglycol-iron nitrate mixtures, THERMOCHIMICA ACTA, Volume: 621, Pages: 61-67, ISSN: 0040-6031, eISSN: 1872-762X, 2015;
4. Iacob, F., Lute, M. Exact solution to the Schrodinger's equation with pseudo-Gaussian potential, JOURNAL OF MATHEMATICAL PHYSICS, Volume: 56, Issue: 12, Article Number: 121501, ISSN: 0022-2488, eISSN: 1089-7658, 2015;
5. Jivulescu, M.A., Lupa, N., Nechita, I. THRESHOLDS FOR REDUCTION-RELATED ENTANGLEMENT CRITERIA IN QUANTUM INFORMATION THEORY, QUANTUM INFORMATION & COMPUTATION, Volume: 15, Issue: 13-14, Pages: 1165-1184, ISSN: 1533-7146, 2015;
6. Lemle, L. On the -Uniqueness of Symmetric Diffusion Operators on Complete Non-Compact Riemannian Manifolds, JOURNAL OF GEOMETRIC ANALYSIS, Volume: 25, Issue: 4, Pages: 2375-2385, ISSN: 1050-6926, eISSN: 1559-002X, 2015;
7. Lihu, A., Holban, S. A review of ensemble methods for de novo motif discovery in ChIP-Seq data, BRIEFINGS IN BIOINFORMATICS, Volume: 16, Issue: 6, Pages: 964-973, PubMed ID: 25888697, ISSN: 1467-5463, eISSN: 1477-4054, 2015;
8. Linul, E., Marsavina, L. Assesment of Sandwich Beams with Rigid Polyurethane Foam Core Using Failure-Mode Maps, PROCEEDINGS OF THE ROMANIAN ACADEMY SERIES A-MATHEMATICS PHYSICS TECHNICAL SCIENCES INFORMATION SCIENCE, Volume: 16, Issue: 4, Pages: 522-530, ISSN: 1454-9069, 2015;
9. Negru, R., Marsavina, L., Voiconi, T., Linul, E., Filipescu, H., Belgiu, G. Application of TCD for brittle fracture of notched PUR materials, THEORETICAL AND APPLIED FRACTURE MECHANICS, Volume: 80, Pages: 87-95, Part: A, Special Issue: SI, ISSN: 0167-8442, eISSN: 1872-7638, 2015;
10. Negru, R., Marsavina, L., Filipescu, H., Caplescu, C., Voiconi, T. Assessment of brittle fracture for PUR materials using local strain energy density and theory of critical distances, THEORETICAL AND APPLIED FRACTURE MECHANICS, Volume: 79, Special Issue: SI, Pages: 62-69, ISSN: 0167-8442, eISSN: 1872-7638, 2015;
11. Osaci, M., Cacciola, M., An adapted Coffey model for studying susceptibility losses in interacting magnetic nanoparticles, BEILSTEIN JOURNAL OF NANOTECHNOLOGY, Volume: 6, Pages: 2173-2182, ISSN: 2190-4286, 2015;
12. Pater, F., Binzar, T. On some dilation theorems for positive definite operator valued functions, STUDIA MATHEMATICA, Volume: 228, Issue: 2, Pages: 109-122, ISSN: 0039-3223, eISSN: 1730-6337, 2015;
13. Popov, D., Dong, S.H., Popov, M. Diagonal ordering operation technique applied to Morse oscillator, ANNALS OF PHYSICS, Volume: 362, Pages: 449-472, ISSN: 0003-4916, eISSN: 1096-035X, 2015;
14. Stoica, M., Ramasamy, P., Kaban, I., Scudino, S., Nicoara, M., Vaughan, G.B.M., Wright, J., Kumar, R., Eckert, J. Structure evolution of soft magnetic (Fe36Co36B19.2Si4.8Nb4)(100-x)Cu-x (x=0 and 0.5) bulk glassy alloys, Acta Materialia, Volume: 95, Pages: 335-342, ISSN: 13596454, eISSN: 18732453, 2015;

15. Alekseev, A.K., Bistriian, D.A., Bondarev, A.E., Navon, I.M. On linear and nonlinear aspects of dynamic mode decomposition, *INTERNATIONAL JOURNAL FOR NUMERICAL METHODS IN FLUIDS*, Volume: 82, Issue: 6, Pages: 348–371, ISSN: 0271–2091, eISSN: 1097–0363, 2016;
16. Ardit, M., Borcanescu, S., Cruciani, G., Dondi, M., Lazau, I., Pacurariu, C., Zanelli, C. Ni-Ti Codoped Hiconite Ceramic Pigments by Combustion Synthesis: Crystal Structure and Optical Properties, *JOURNAL OF THE AMERICAN CERAMIC SOCIETY*, Volume: 99, Issue: 5, Pages: 1749–1760, ISSN: 0002–7820, eISSN: 1551–2916, 2016;
17. Belega, D., Petri, D. Accuracy analysis of the sine-wave parameters estimation by means of the windowed three-parameter sine-fit algorithm, *DIGITAL SIGNAL PROCESSING*, Volume: 50, Pages: 12–ISSN: 1051–2004, eISSN: 1095–4333, 2016;
18. Belega, D., Petri, D., Dallet, D. Accuracy analysis of complex sinusoid amplitude and phase estimation by means of the interpolated discrete-time Fourier transform algorithm, *DIGITAL SIGNAL PROCESSING*, Volume: 59, Pages: 9–18, ISSN: 1051–2004, eISSN: 1095–4333, 2016;
19. Belega, D., Petri, D., Dallet, D. Impact of harmonics on the interpolated DFT frequency estimator, *MECHANICAL SYSTEMS AND SIGNAL PROCESSING*, Volume: 66–67, Pages: 349–360, ISSN: 0888–3270, 2016;
20. Bernad, S.I., Totorean, A.E., Vekas, L. Particles deposition induced by the magnetic field in the coronary bypass graft model, *JOURNAL OF MAGNETISM AND MAGNETIC MATERIALS*, Volume: 401, Pages: 269–286, ISSN: 0304–8853, eISSN: 1873–4766, 2016;
21. Bistriian, D.A., Susan-Resiga, R.F. Weighted proper orthogonal decomposition of the swirling flow exiting the hydraulic turbine runner, *APPLIED MATHEMATICAL MODELLING*, Volume: 40, Issue: 5–6, Pages: 4057–4078, ISSN: 0307–904X, eISSN: 1872–8480, 2016;
22. Bordeasu, I., Mitelea, I., Salcianu, L., Craciunescu, C.M. Cavitation Erosion Mechanisms of Solution Treated X5CrNi18–10 Stainless Steels, *JOURNAL OF TRIBOLOGY-TRANSACTIONS OF THE ASME*, Volume: 138, Issue: 3, Article Number: 031102, ISSN: 0742–4787, eISSN: 1528–8897, 2016;
23. Camacho, O.M.F., Mihet-Popa, L. Fast Charging and Smart Charging Tests for Electric Vehicles Batteries Using Renewable Energy, *OIL & GAS SCIENCE AND TECHNOLOGY-REVUE D IFP ENERGIES NOUVELLES*, Volume: 71, Issue: 1, Article Number: 13, ISSN: 1294–4475, eISSN: 1953–8189, 2016;
24. Cindea, L., Hatiegan, C., Pop, N., Negrea, R., Raduca, E., Gillich, G.R., Danut, M., Nedeloni, M.D. The influence of thermal field in the electric arc welding of X60 carbon steel components in the CO₂ environment, *APPLIED THERMAL ENGINEERING*, Volume: 103, Pages: 1164–1175, ISSN: 1359–4311, 2016;
25. Ciocan, T., Susan-Resiga, R.F., Muntean, S. Modelling and optimization of the velocity profiles at the draft tube inlet of a Francis turbine within an operating range, *JOURNAL OF HYDRAULIC RESEARCH*, Volume: 54, Issue: 1, Pages: 74–89, ISSN: 0022–1686, eISSN: 1814–2079, 2016;
26. Craciunescu, C., Ercuta, A. Shape memory microactuation design by substrate's reinforcement layers, *MATERIALS & DESIGN*, Volume: 96, Pages: 364–369, ISSN: 0261–3069, eISSN: 1873–4197, 2016;
27. Crisan, A., Dubina, D. Bending-shear interaction in short coupling steel beams with reduced beam section, *JOURNAL OF CONSTRUCTIONAL STEEL RESEARCH*, Volume: 122, Pages: 190–197, ISSN: 0143–974X, eISSN: 1873–5983, 2016;
28. Curiac, D.I. Towards wireless sensor, actuator and robot networks: Conceptual framework, challenges and perspectives, *JOURNAL OF NETWORK AND COMPUTER APPLICATIONS*, Volume: 63, Pages: 14–23, ISSN: 1084–8045, 2016;
29. Curiac, D.I. Wireless Sensor Network Security Enhancement Using Directional Antennas: State of the Art and Research Challenges, *SENSORS*, Volume: 16, Issue: 4, Article Number: 488, ISSN: 1424–8220, 2016;
30. Dan, D., Tanasa, C., Stoian, V., Brata, S., Stoian, D., Nagy-Gyorgy, T., Florut, S.C. Passive house design—An efficient solution for residential buildings in Romania, *ENERGY FOR SUSTAINABLE DEVELOPMENT*, Volume: 32, Pages: 99–109, ISSN: 0973–0826, 2016;
31. Dinu, F., Marginean, I., Dubina, D., Petran, I. Experimental testing and numerical analysis of 3D steel frame system under column loss, *ENGINEERING STRUCTURES*, Volume: 113, Pages: 59–70, ISSN: 0141–0296, eISSN: 1873–7323, 2016;
32. Ene, R.D., Marinca, V., Marinca, B. Analytic Approximate Solutions to the Boundary Layer Flow Equation over a Stretching Wall with Partial Slip at the Boundary, *PLOS ONE*, Volume: 11, Issue: 3, Article Number: e0149334, ISSN: 1932–6203, 2016;

33. Epee, M.D.E., Mezei, J.Z., Motapon, O., Pop, N., Schneider, I.F. Reactive collisions of very low-energy electrons with H-2(+): rotational transitions and dissociative recombination, MONTHLY NOTICES OF THE ROYAL ASTRONOMICAL SOCIETY, Volume: 455, Issue: 1, Pages: 276-281, ISSN: 0035-8711, eISSN: 1365-2966, 2016;
34. Fagadar-Cosma, E., Sebarchievici, I., Lascu, A., Creanga, I., Palade, A., Birdeanu, M., Taranu, B., Fagadar-Cosma, G. Optical and electrochemical behavior of new nano-sized complexes based on gold-colloid and Co-porphyrin derivative in the presence of H₂O₂, JOURNAL OF ALLOYS AND COMPOUNDS, Volume: 686, Pages: 896-904, ISSN: 0925-8388, eISSN: 1873-4669, 2016;
35. Fagadar-Cosma, E., Tarabukina, E., Zakharova, N., Birdeanu, M., Taranu, B., Palade, A., Creanga, I., Lascu, A., Fagadar-Cosma, G. Hybrids formed between polyvinylpyrrolidone and an A(3)B porphyrin dye: behaviour in aqueous solutions and chemical response to CO₂ presence, POLYMER INTERNATIONAL, Volume: 65, Issue: 2, Pages: 200-209, ISSN: 0959-8103, eISSN: 1097-0126, 2016;
36. Filip, I., Szeidert, I. Adaptive fuzzy PI controller with shifted control singletons, EXPERT SYSTEMS WITH APPLICATIONS, Volume: 54, Pages: 1-12, ISSN: 0957-4174, eISSN: 1873-6793, 2016;
37. Gabor, A.E., Davidescu, C.M., Negrea, A., Ciopec, M., Butnariu, M., Ianasi, C., Muntean, C., Negrea, P. Lanthanum Separation from Aqueous Solutions Using Magnesium Silicate Functionalized with Tetrabutylammonium Dihydrogen Phosphate, JOURNAL OF CHEMICAL AND ENGINEERING DATA, Volume: 61, Issue: 1, Pages: 535-542, ISSN: 0021-9568, 2016;
38. Gheju, M., Balcu, I., Mosoarca, G. Removal of Cr(VI) from aqueous solutions by adsorption on MnO₂, JOURNAL OF HAZARDOUS MATERIALS, Volume: 310, Pages: 270-277, ISSN: 0304-3894, eISSN: 1873-3336, 2016;
39. Gheju, M., Balcu, I., Vancea, C. An investigation of Cr(VI) removal with metallic iron in the co presence of sand and/or MnO₂, JOURNAL OF ENVIRONMENTAL MANAGEMENT, Volume: 170, Pages: 145-151, ISSN: 0301-4797, eISSN: 1095-8630, 2016;
40. Hadaruga, D.I., Costescu, C.I., Corpas, L., Hadaruga, N.G., Isengard, H.D. Differentiation of rye and wheat flour as well as mixtures by using the kinetics of Karl Fischer water titration, FOOD CHEMISTRY, Volume: 195, Pages: 49-55, ISSN: 0308-8146, eISSN: 1873-7072, 2016;
41. Hadaruga, D.I., Unlusayin, M., Gruia, A.T., Birau, C., Rusu, G., Hadaruga, N.G., Thermal and oxidative stability of Atlantic salmon oil (Salmo salar L.) and complexation with beta-cyclodextrin, BEILSTEIN JOURNAL OF ORGANIC CHEMISTRY, Volume: 12, Pages: 179-191, ISSN: 1860-5397, 2016;
42. Herrmann, M., Ottesteanu, M., A MAP estimator based on geometric Brownian motion for sample distances of laser triangulation data, OPTICS AND LASERS IN ENGINEERING, Volume: 86, Pages: 98-105, ISSN: 0143-8166, eISSN: 1873-0302, 2016;
43. Ianos, R., Istratie, R., Pacurariu, C., Lazau, R. Solution combustion synthesis of strontium aluminate, SrAl₂O₄, powders: single-fuel versus fuel-mixture approach, PHYSICAL CHEMISTRY CHEMICAL PHYSICS, Volume: 18, Issue: 2, Pages: 1150-1157, ISSN: 1463-9076, eISSN: 1463-9084, 2016;
44. Ioan, A., Stratan, A., Dubina, D., Poljansek, M., Molina, F.J., Taucer, F., Pegon, P., Sabau, G. Experimental validation of re-centring capability of eccentrically braced frames with removable links, ENGINEERING STRUCTURES, Volume: 113, Pages: 335-346, ISSN: 0141-0296, eISSN: 1873-7323, 2016;
45. Javadi, A., Bosioc, A., Nilsson, H., Muntean, S., Susan-Resiga, R. Experimental and Numerical Investigation of the Precessing Helical Vortex in a Conical Diffuser, With Rotor-Stator Interaction, JOURNAL OF FLUIDS ENGINEERING-TRANSACTIONS OF THE ASME, Volume: 138, Issue: 8, Article Number: 081106, ISSN: 0098-2202, eISSN: 1528-901X, 2016;
46. Lascu, A., Palade, A., Fagadar-Cosma, G., Creanga, I., Ianasi, C., Sebarchievici, I., Birdeanu, M., Fagadar-Cosma, E. Mesoporous manganese-porphyrin-silica hybrid nanomaterial sensitive to H₂O₂ fluorescent detection, MATERIALS RESEARCH BULLETIN, Volume: 74, Pages: 325-332, ISSN: 0025-5408, eISSN: 1873-4227, 2016;
47. Ledeti, I., Ledeti, A., Vlase, G., Vlase, T., Matusz, P., Bercean, V., Suta, L.M., Piciu, D. Thermal stability of synthetic thyroid hormone L-thyroxine and L-thyroxine sodium salt hydrate both pure and in pharmaceutical formulations, JOURNAL OF PHARMACEUTICAL AND BIOMEDICAL ANALYSIS, Volume: Pages: 33-40, PubMed ID: 26999320, ISSN: 0731-7085, eISSN: 1873-264X, 2016;
48. Malaescu, I., Lungu, A., Marin, C.N., Vlazan, P., Sfirloaga, P., Turi, G.M. Experimental investigations of the structural transformations induced by the heat treatment in manganese ferrite synthesized by ultrasonic assisted co-precipitation method, CERAMICS INTERNATIONAL, Volume: 42, Issue: 15, Pages: 16744-16748, ISSN: 0272-8842, eISSN: 1873-3956, 2016;

49. Marinica, O., Susan-Resiga, D., Balanean, F., Vizman, D., Socoliuc, V., Vekas, L. Nano-micro composite magnetic fluids: Magnetic and magnetorheological evaluation for rotating seal and vibration damper applications, *JOURNAL OF MAGNETISM AND MAGNETIC MATERIALS*, Volume: 406, Pages: 134-143, ISSN: 0304-8853, eISSN: 1873-4766, 2016;
50. Marsavina, L., Kovacic, J., Linul, E. Experimental validation of micromechanical models for brittle aluminium alloy foam, *THEORETICAL AND APPLIED FRACTURE MECHANICS*, Volume: 83, Pages: 11-18, ISSN: 0167-8442, eISSN: 1872-7638, 2016;
51. Mezei, J.Z., Colboc, F., Pop, N., Ilie, S., Chakrabarti, K., Niyonzima, S., Lepers, M., Bultel, A., Dulieu, O., Motapon, O., Tennyson, J., Hassouni, K., Schneider, I.F. Dissociative recombination and vibrational excitation of BF⁺ in low energy electron collisions, *PLASMA SOURCES SCIENCE & TECHNOLOGY*, Volume: 25, Issue: 5, Article Number: 055022, ISSN: 0963-0252, eISSN: 1361-6595, 2016;
52. Mitelea, I., Oanca, O., Bordeasu, I., Craciunescu, C.M. Cavitation Erosion of Cermet-Coated Aluminium Bronzes, *MATERIALS*, Volume: 9, Issue: 3, Article Number: 204, ISSN: 1996-1944, 2016;
53. Negru, R., Serban, D.A., Marsavina, L., Magda, A. Lifetime prediction in medium-cycle fatigue regime of notched specimens, *THEORETICAL AND APPLIED FRACTURE MECHANICS*, Volume: 84, Special Issue: SI, Pages: 140-148, ISSN: 0167-8442, eISSN: 1872-7638, 2016;
54. Nelson, J.D.B., Naforita, C., Isar, A. Semi-Local Scaling Exponent Estimation With Box-Penalty Constraints and Total-Variation Regularization, *IEEE TRANSACTIONS ON IMAGE PROCESSING*, Volume: 25, Issue: 7, Pages: 3167-3181, ISSN: 1057-7149, eISSN: 1941-0042, 2016;
55. Nicoara, M., Raduta, A., Parthiban, R., Locovei, C., Eckert, J., Stoica, M. Low Young's modulus Ti-based porous bulk glassy alloy without cytotoxic elements, *ACTA BIOMATERIALIA*, Volume: 36, Pages: 323-331, ISSN: 1742-7061, eISSN: 1878-7568, 2016;
56. Niculescu, M., Sasca, V., Muntean, C., Milea, M.S., Rosu, D. Pascariu, M.C., Sisu, E., Ursoiu, I., Pode, V., Budrugaec, P. Thermal behavior studies of the homopolynuclear coordination compound iron(III) polyoxalate, *THERMOCHIMICA ACTA*, Volume: 623, Pages: 36-42, ISSN: 0040-6031, eISSN: 1872-762X, 2016;
57. Paulescu, M., Stefu, N., Calinoiu, D., Paulescu, E., Pop, N., Boata, R., Mares, O. Angstrom-PreScott equation: Physical basis, empirical models and sensitivity analysis, *RENEWABLE & SUSTAINABLE ENERGY REVIEWS*, Volume: 62, Pages: 495-506, ISSN: 1364-0321, 2016;
58. Radac, M.B., Precup, R.E. Three-level hierarchical model-free learning approach to trajectory tracking control, *ENGINEERING APPLICATIONS OF ARTIFICIAL INTELLIGENCE*, Volume: 55, Pages: 103-118, ISSN: 0952-1976, eISSN: 1873-6769, 2016;
59. Raduta, A., Nicoara, M., Locovei, C., Eckert, J., Stoica, M. Ti-based bulk glassy composites obtained by replacement of Ni with Ga, *INTERMETALLICS*, Volume: 69, Pages: 28-34, ISSN: 0966-9795, eISSN: 1879-0216, 2016;
60. Roman, R.C., Radac, M.B., Precup, R.E. Multi-input-multi-output system experimental validation of model-free control and virtual reference feedback tuning techniques, *IET CONTROL THEORY AND APPLICATIONS*, Volume: 10, Issue: 12, Special Issue: SI, Pages: 1395-1403, ISSN: 1751-8644, eISSN: 1751-8652, 2016;
61. Sahebkar, A., Gurban, C., Serban, A., Andrica, F., Serban, M.C. Effects of supplementation with pomegranate juice on plasma C-reactive protein concentrations: A systematic review and meta-analysis of randomized controlled trials, *PHYTOMEDICINE*, Volume: 23, Issue: 11, Special Issue: SI, Pages: 1095-1102, PubMed ID: 26922037, ISSN: 0944-7113, eISSN: 1618-095X, 2016;
62. Sarbu, I., Ostafe, G. Optimal design of urban water supply pipe networks, *URBAN WATER JOURNAL*, Volume: 13, Issue: 5, Pages: 521-535, ISSN: 1573-062X, eISSN: 1744-9006, 2016;
63. Serban, D.A., Weissenborn, O., Geller, S., Marsavina, L., Gude, M. Evaluation of the mechanical and morphological properties of long fibre reinforced polyurethane rigid foams, *POLYMER TESTING*, Volume: 49, Pages: 121-127, ISSN: 0142-9418, eISSN: 1873-2348, 2016;
64. Stefu, N., Paulescu, M., Blaga, R., Calinoiu, D., Pop, N., Boata, R., Paulescu, E. A theoretical framework for Angstrom equation. Its virtues and liabilities in solar energy estimation, *ENERGY CONVERSION AND MANAGEMENT*, Volume: 112, Pages: 236-245, ISSN: 0196-8904, eISSN: 1879-2227, 2016;
65. Susan-Resiga, R.F., Muntean, S., Stuparu, A., Bosioc, A.I., Tanasa, C., Ighisan, C. A variational model for swirling flow states with stagnant region, *EUROPEAN JOURNAL OF MECHANICS B-FLUIDS*, Volume: 55, Pages: 104-115, ISSN: 0997-7546, eISSN: 1873-7390, 2016;
66. Tekle-Rottering, A., Jewell, K.S., Reisz, E., Lutze, H.V., Ternes, T.A., Schmidt, W., Schmidt, T.C. Ozonation of piperidine, piperazine and morpholine: Kinetics, stoichiometry, product formation and mechanistic considerations, *WATER RESEARCH*, Volume: 88, Pages: 960-971, PubMed ID: 26624229, ISSN: 0043-1354, 2016;

67. Tekle-Rottering, A., Reisz, E., Jewell, K.S., Lutze, H.V., Ternes, T.A., Schmidt, W., Schmidt, T.C. Ozonation of pyridine and other N-heterocyclic aromatic compounds: Kinetics, stoichiometry, identification of products and elucidation of pathways, *WATER RESEARCH*, Volume: 102, Pages: 582-593, PubMed ID: 27448509, ISSN: 0043-1354, 2016;
68. Tekle-Rottering, A., von Sonntag, C., Reisz, E., vom Eyser, C., Lutze, H.V., Turk, J., Naumov, S., Schmidt, W., Schmidt, T.C. Ozonation of anilines: Kinetics, stoichiometry, product identification and elucidation of pathways, *WATER RESEARCH*, Volume: 98, Pages: 147-159, PubMed ID: 27088249, ISSN: 0043-1354, 2016;
69. Tigan, G., Llibre, J. Heteroclinic, Homoclinic and Closed Orbits in the Chen System, *INTERNATIONAL JOURNAL OF BIFURCATION AND CHAOS*, Volume: 26, Issue: 4, Article Number: 1650072, ISSN: 0218-1274, eISSN: 1793-6551, 2016;
70. Tiwari, A.K., Albulescu, C.T. Oil price and exchange rate in India: Fresh evidence from continuous wavelet approach and asymmetric, multi-horizon Granger-causality tests, *APPLIED ENERGY*, Volume: 179, Pages: 272-283, ISSN: 0306-2619, eISSN: 1872-9118, 2016;
71. Tiwari, A.K., Albulescu, C.T. Renewable-to-total electricity consumption ratio: Estimating the permanent or transitory fluctuations based on flexible Fourier stationarity and unit root tests, *RENEWABLE & SUSTAINABLE ENERGY REVIEWS*, Volume: 57, Pages: 1409-1427, ISSN: 1364-0321, 2016;
72. Topirceanu, A., Duma, A., Udrescu, M. Uncovering the fingerprint of online social networks using a network motif based approach, *COMPUTER COMMUNICATIONS*, Volume: 73, Special Issue: SI, Pages: 167-175, ISSN: 0140-3664, eISSN: 1873-703X, 2016;
73. Udrescu, L., Sbarcea, L., Topirceanu, A., Iovanovici, A., Kurunzi, L., Bogdan, P., Udrescu, M. Clustering drug-drug interaction networks with energy model layouts: community analysis and drug repurposing, *SCIENTIFIC REPORTS*, Volume: 6, Article Number: 32745, PubMed ID: 27599720, ISSN: 2045-2322, 2016;
74. Unlusayin, M., Hadaruga, N.G., Rusu, G., Gruia, A.T., Paunescu, V., Hadaruga, D.I. Nano-encapsulation competitiveness of omega-3 fatty acids and correlations of thermal analysis and Karl Fischer water titration for European anchovy (*Engraulis encrasicolus* L.) oil/beta-cyclodextrin complexes, *LWT-FOOD SCIENCE AND TECHNOLOGY*, Volume: 68, Pages: 135-144, ISSN: 0023-6438, eISSN: 1096-1127, 2016;
75. Utu, I.D., Mitelea, I., Urgan, S.D., Craciunescu, C.M., Transformation and Precipitation Reactions by Metal Active Gas Pulsed Welded Joints from X2CrNiMoN22-5-3 Duplex Stainless Steels, *MATERIALS*, Volume: 9, Issue: 7, Article Number: 606, ISSN: 1996-1944, 2016;
76. Vintila, T., Negrea, A., Barbu, H., Sumalan, R., Kovacs, K. Metal distribution in the process of lignocellulosic ethanol production from heavy metal contaminated sorghum biomass, *JOURNAL OF CHEMICAL TECHNOLOGY AND BIOTECHNOLOGY*, Volume: 91, Issue: 6, Pages: 1607-1614, ISSN: 0268-2575, eISSN: 1097-4660, 2016;
77. Zagari, G., Zucco, G., Madeo, A., Ungureanu, V., Zinno, R., Dubina, D. Evaluation of the erosion of critical buckling load of cold-formed steel members in compression based on Koiter asymptotic analysis, *THIN-WALLED STRUCTURES*, Volume: 108, Pages: 193-204, ISSN: 0263-8231, eISSN: 1879-3223, 2016.

PROJECTS SUPPORTED BY PUBLIC FUNDS

National Research Projects

PROJECTS SUPPORTED BY NATIONAL PUBLIC FUNDS IMPLEMENTED BY PUT 2016

Fields	Total number of projects	Number of projects presented
Socio-economic and humanist research	2	2
Eco-Nano-Tehnologies and advanced materials	2	-
Energy, environment and climatic changes	17	12
Mathematics and Informatics	2	2
Materials, Processes and Innovative Products	5	2
Fracture mechanics, Characterization of mechanical behavior of composite materials, Optical measurementsg	1	-
Microwave, Antennas and Propagation, Electromagnetic Compatibility, Metamaterials	1	-
Materials science	3	2
Engineering science	15	10
Earth science	1	1
Applied Life Sciences and Biotechnologies	3	3
Information and Communication Technology, Space and Security	8	7
Total	60	41

EVOLUTION OF PROJECTS SUPPORTED BY NATIONAL PUBLIC FUNDS IMPLEMENTED BY PUT 2012 - 2016

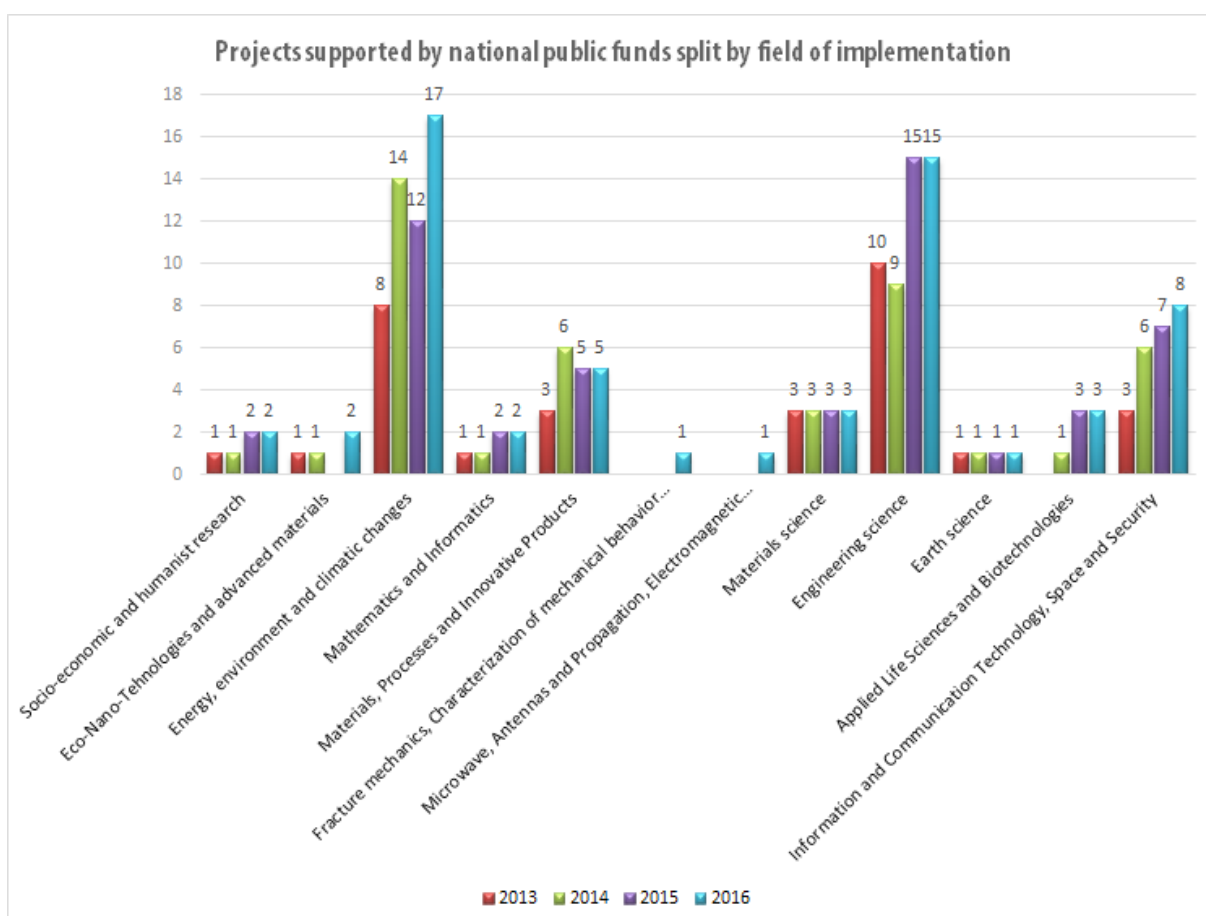
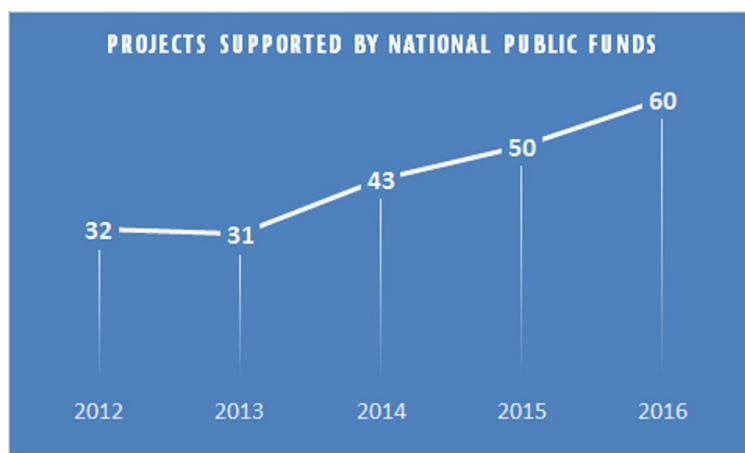

NEW PERFORMANCE IMPROVEMENT TECHNIQUES OF CONTROL SYSTEMS USING EXPERIMENT-BASED TUNING

Goal of the project

- Enhancement and development of data-based (data-driven) techniques and algorithms for improving control system performances using experimental data.
- Enhancement and development of nature-inspired algorithms in optimization of control system performance.
- Development of optical character recognition (OCR) applications.
- Development of new fuzzy control solutions for a wide range of industrial processes.

Short description of the project

Enhance existing techniques, develop new ones for data-based control system performance improvement.

Project implemented by

Department of Automation and Applied Informatics of UPT
<http://www.aut.upt.ro/~rprecup/grant2011.html>

Implementation period

2011–2016.

Main activities

- Application of Iterative Feedback Tuning (IFT) to controller tuning for nonlinear control systems.
- Model-Free Adaptive Control strategies applied to aerodynamic systems.
- An experiment-based approach to Reference Trajectory Tracking optimal control problem with constraints.
- Validation of iterative techniques on laboratory equipment: liquid level control, motion control systems with motor actuation (speed and position control).
- Enhancement of control systems performance by fuzzy control, IFT and nature-inspired optimization algorithms.
- PI and fuzzy controller tuning to ensure a reduced process parametric sensitivity.
- Improve the training algorithm of Convolutional Neural Networks using mixed Back-Propagation and nature-inspired optimization algorithms.

Results

- 8 papers published in Thomson Reuters Web of Science (WoS) journals with impact factors.
- 7 papers published in conference proceedings indexed in WoS.
- 3 papers published in conference proceedings indexed in international databases.
- 1 book chapter published in a Springer-Verlag volume.
- More than 30 independent citations in 2016.

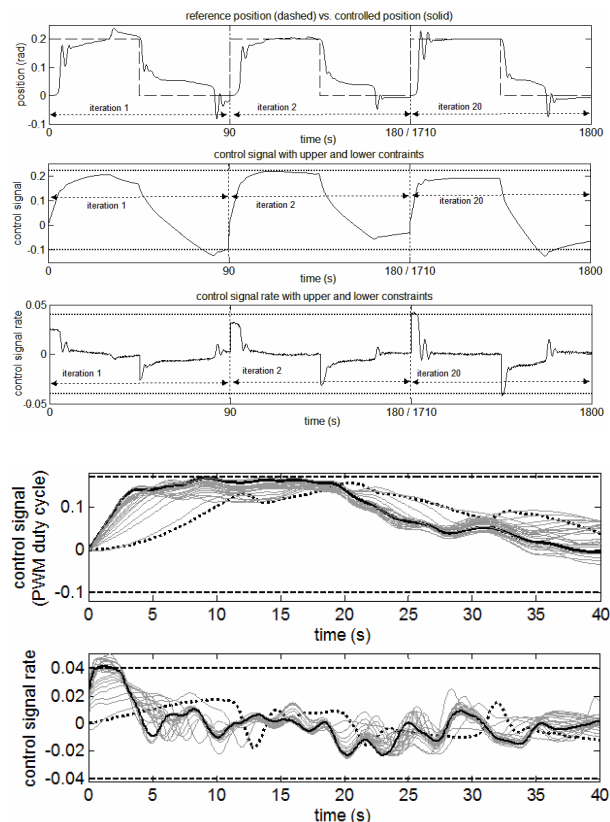

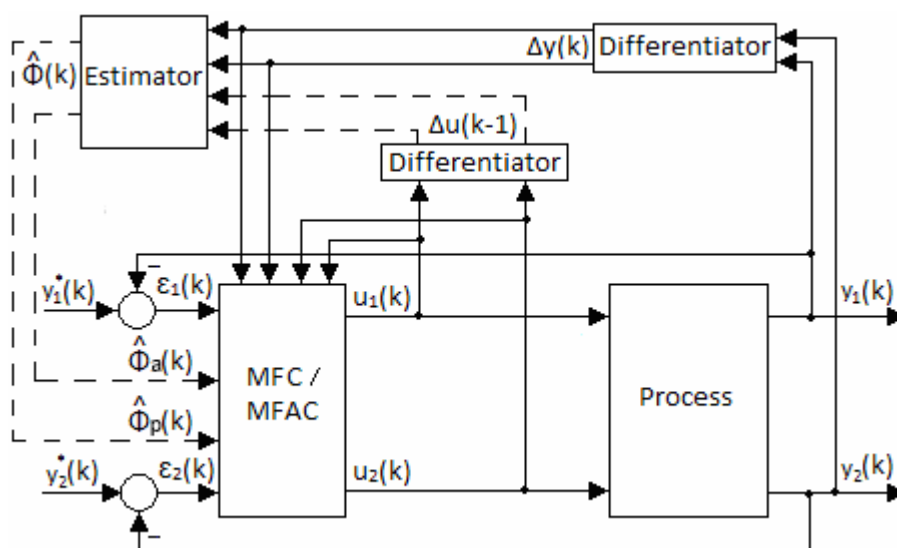

Applicability and transferability of the results

Control systems with a reduced parametric sensitivity, tools for the computer-aided design of controllers, computer-aided techniques in iterative data-based control, nature-inspired optimization algorithms in control design and image processing, tools for the systematic development of fuzzy control systems.

Financed through/by

Executive Agency for Higher Education, Research, Development and Innovation Funding (UEFISCDI), Bucharest, Romania.

Research Centre

Automatic Systems Engineering Research Centre (CCISA).
<http://www.aut.upt.ro/centru-cercetare/index.EN.php>

Research team

Prof. Dr. Ing. Radu-Emil Precup – director, principal investigator
 Prof. Dr. Ing. Stefan Preitl – senior staff member
 Assoc. Prof. Dr. Ing. Florin Drăgan – senior staff member
 Lect. Dr. Ing. Daniel Iercan – post doc
 Lect. Dr. Ing. Mircea-Bogdan Rădac – post doc
 Lect. Dr. Ing. Claudia-Adina Bojan-Dragoș – post doc
 Assist. Lect. Dr. Ing. Alexandra-Iulia Szedlak-Stînean – post doc
 M.Sc. Dipl. Ing. Lucian-Ovidiu Fedorovici – Ph.D. student

Contact information

Prof. Radu-Emil PRECUP, PhD
 Politehnica University of Timisoara
 Department of Automation and Applied Informatics
 Bd. V. Parvan 2, 300223 Timisoara, Romania
 Phone: (+40) 256 403229
 Fax: (+40) 256 403214
 E-mail: radu.precup@upt.ro
<http://www.aut.upt.ro/~rprecup/>

CONTROL ALGORITHMS AND OPTIMAL TUNING OF FUZZY MODELS FOR AUTOMOTIVE, MECHATRONICS APPLICATIONS AND MOBILE ROBOTS

Goal of the project

- Development of advanced control structures for automotive and mechatronics applications.
- Improvement and development of new Takagi-Sugeno (T-S) fuzzy models and control solutions for a wide range of industrial processes, mechatronics, mobile robots and automotive applications.
- Optimal tuning of fuzzy models for automotive and mechatronics applications.
- Improvement and development of control algorithms for mobile robots.

Short description of the project

Advanced control structures and optimal tuning of fuzzy models for a wide range of industrial processes are offered.

Project implemented by

Department of Automation and Applied Informatics of UPT as the P1 partner, coordinator: "Gheorghe Asachi" Technical University of Iasi (TUIASI), P2 partner: S.C. ROMUS Trading & Development SRL, director: Prof. Dr. Eng. Silvia Curteanu (TUIASI).

Implementation period

2012-2016.

Main activities

- Development and experimental validation of simple T-S fuzzy models, evolving fuzzy models and advanced controllers (2-DOF, predictive and fuzzy) for processes in automotive and mechatronics: anti-lock braking systems, nonlinear DC drive servo systems, magnetic levitation systems.
- Continuous development of the nRobotic platform for path planning and collision avoidance of mobile robots in missions.
- Modeling, simulation, analysis and development of: T-S PD + I fuzzy controllers, 2-DOF linear and fuzzy controllers, hybrid T-S fuzzy controllers for speed and position control of brushless DC drives with variable parameters and inputs.
- Optimal tuning of parameters of T-S fuzzy models using nature-inspired algorithms: charged system search, grey wolf optimization, gravitational search algorithms.

Results

- 12 papers published in Thomson Reuters Web of Science (WoS) journals with impact factors.
- 14 papers published in conference proceedings indexed in WoS.
- 26 papers published in conference proceedings indexed in international databases.
- 3 papers published in journals indexed in international databases.
- More than 50 independent citations in 2016.

Applicability and transferability of the results

- Nature-inspired evolutionary-based optimization algorithms in modeling and control design.
- Cost-effective solutions for control problems in mechatronics, electrical drives, automotive and robotics.
- Tools for the modeling, optimization and design of fuzzy control systems.
- Real-time programming and operating systems for control and robotics.

Financed through/by

Executive Agency for Higher Education, Research, Development and Innovation Funding (UEFISCDI), Bucharest, Romania.

Research Centre

Automatic Systems Engineering Research Centre (CCISA).
<http://www.aut.upt.ro/centru-cercetare/index.EN.php>

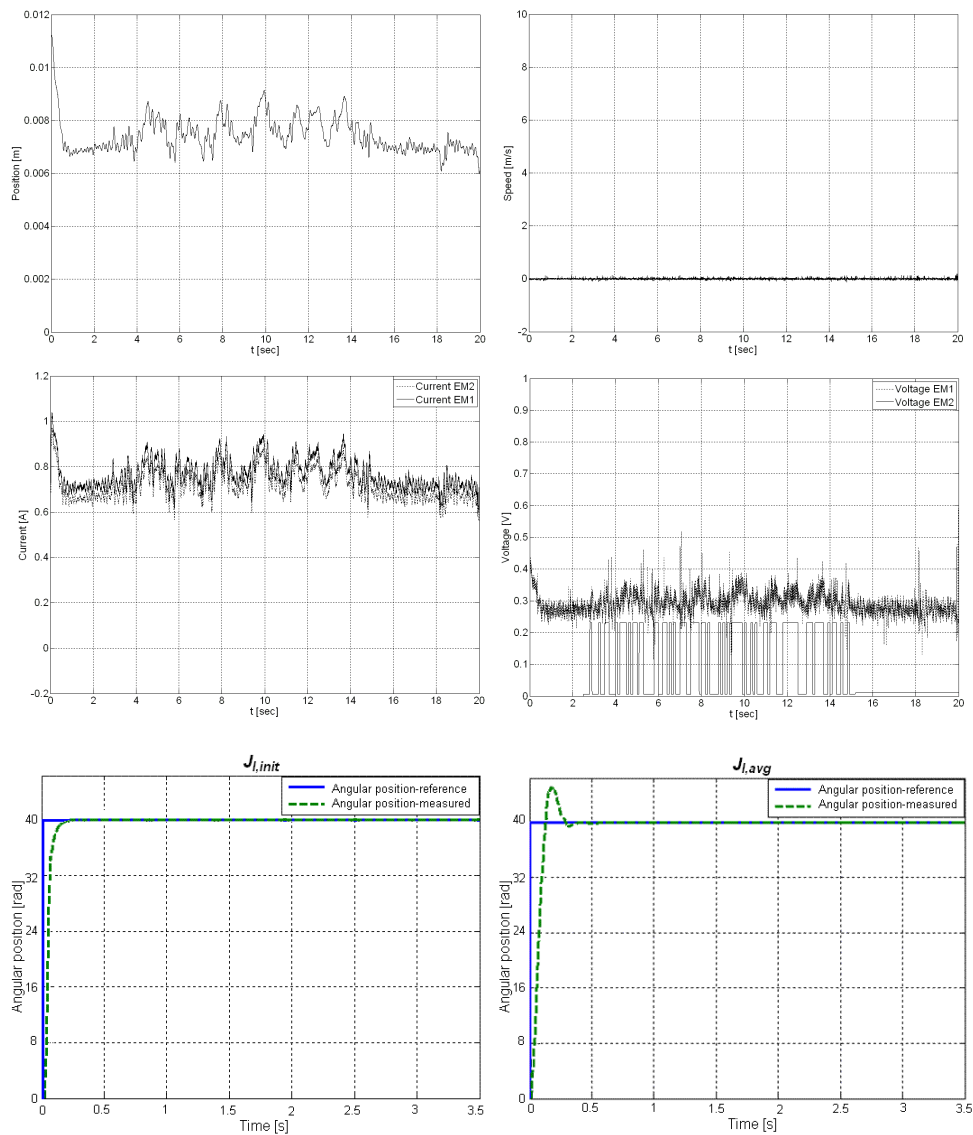

Research team

Prof. Dr. Eng. Radu-Emil Precup - director
 Prof. Dr. Eng. Stefan Preitl
 Prof. Dr. Eng. Ioan Filip
 Assoc. Prof. Dr. Eng. Florin Drăgan
 Lect. Dr. Eng. Adriana Albu
 Lect. Dr. Eng. Ovidiu Baniș
 Lect. Dr. Eng. Daniel Iercan
 Lect. Dr. Eng. Mircea-Bogdan Rădac
 Lect. Dr. Eng. Claudia-Adina Bojan-Dragoș
 Assist. Lect. Dr. Eng. Alexandra-Iulia Szedlak-Stinean, PhD student
 M.Sc. Eng. Lucian-Ovidiu Fedorovici, PhD student
 M.Sc. Eng. Constantin Purcaru

Contact information

Prof. Radu-Emil PRECUP, PhD
 Politehnica University of Timisoara
 Department of Automation and Applied Informatics
 Bd. V. Parvan 2, 300223 Timisoara, Romania
 Phone: (+40) 256 403229
 Fax: (+40) 256 403214
 E-mail: radu.precup@upt.ro
<http://www.aut.upt.ro/~rprecup/>

HYBRID SYSTEMS FOR CONVERTING RENEWABLE ENERGY OF SMALL VOLTAGE INTEGRATED INTO A MICROGRID

Goal of the project

The project is focused on the research, development and testing of an intelligent and flexible (configurable) small scale power system based on integration of three renewable energy sources: wind, hydro, and solar (photovoltaic) power, adapted to the available resources in Romania, in various regions of the country, working independently or connected to the grid.

Short description of the project

The project covers the entire power conversion structure, including the design of adequate prime movers and new types of generators and power electronic converters, storage devices, power flow management system and load control. Some configurable structures (wind, micro-hydro and PV, all or a part of them, including their integration in a microgrid) are proposed as experimental models, ready to be transferred to industry. There are proposed novelty elements regarding: low power wind turbine with integrated overspeed protection system, new generators configurations, and new topologies for power electronic converters and microgrid structures, optimal local control strategies and intelligent power system management.

Project implemented by

Politehnica University of Timisoara – Project coordinator
 Technical University of Cluj-Napoca – Project partner
 SC EETIM SA – Project partner

Implementation period

2012–2016

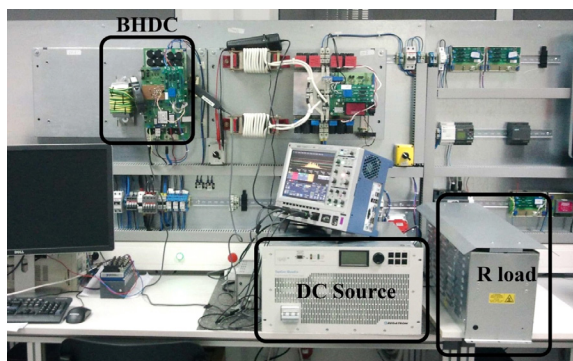

Main activities

- Microgrid components modeling, simulation and design.
- Microgrid components manufacturing, individual testing and integration in the experimental setup.
- Design, implementation and validation of the control strategies for microgrid components.
- Design, implementation and validation of the microgrid control strategy.
- Results dissemination and know-how exchange.

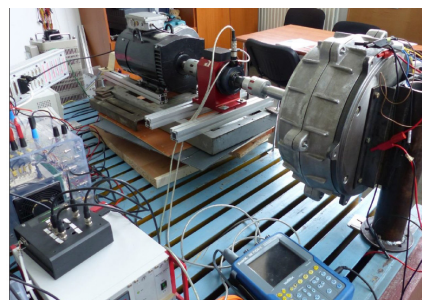

Results

- A new over-speed protection system for wind turbines.
- A new electrical reactive brushless dc generator with performances comparable with high energy PM generator, at low cost.
- A new RF-IPMSG with high efficiency, maintenance-free operation, and high-controllability.
- A new AF-PMSG optimized for modular design. A new multiphase inverter with adequate control for the proposed generators.
- New multi-input dc-dc converters with high efficiency.
- High power tandem inverters for load management.
- Hardware and software package for power management, power flow control, individual converter control, and MPPT and other control strategies.
- Experimental microgrid system with integrated photovoltaic, wind and hydro generation.
- Technical papers published in top international journals and conference proceedings.



Applicability and transferability of the results

All the research results are the property of the project coordinator and its partners..

Financed through/by

Joint Applied Research Projects - Partnership in S&T priority domains financed by the Executive Agency for Higher Education, Research, Development and Innovation Funding (UEFISCDI).



Research centre

Research Centre for Automatic Systems Engineering

Research team

Octavian Prostean
Nicolae Muntean
Nicolae Budisan
Ioan Filip
Mircea Barglazan
Stefan Kilyeni
Ilarie Bordeasu
Teodor Milos
Cristian Vasar
Iosif Szeidert-Subert
Lucian Tutelea
Cristian Lascu
Sorin Deaconu
Gabriela Prostean
Dan Ungureanu
Andreea Robu
Adrian Bej
Radu Boraci
Octavian Cornea
Ovidiu Tirian
Rodica Badarau

Contact information

Prof. Octavian PROSTEAN, PhD
Department of Automation and Applied Informatics
Address: Bv. Vasile Parvan, No. 2, 300223, Timișoara
Phone: (+40) 256 403 225
E-mail: octavian.prostean@upt.ro

CSEAMAN - CRYPTOGRAPHIC SECURITY FOR AUTOMOTIVE EMBEDDED DEVICES AND NETWORKS

Goal of the project:

The design and analysis of cryptographic security solutions for automotive embedded devices and networks

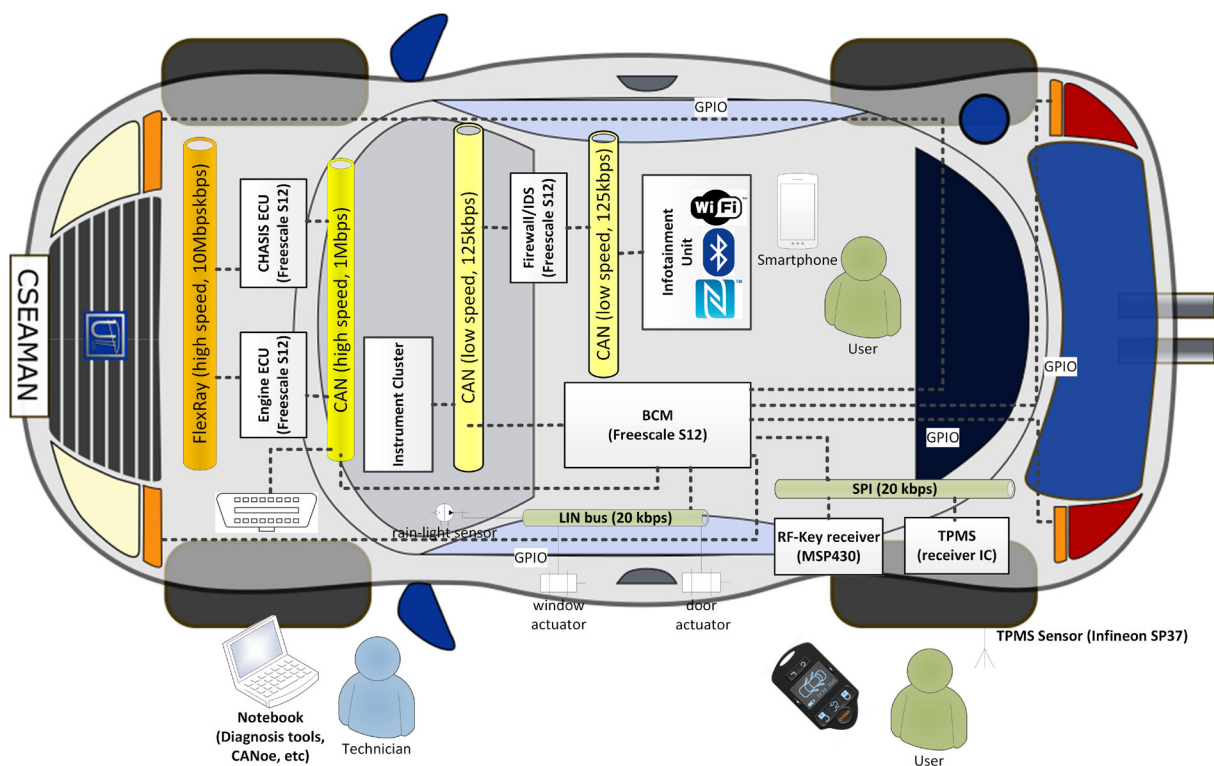

Short description of the project:

The project aims at the design and analysis of cryptographic security solutions with applications in the automotive domain. Our main challenge is to accommodate cryptographic security on automotive-grade devices with low computational and memory resources that communicate over in-vehicle networks with constrained bandwidth. We focus both on wired and wireless channels that open cars to outsiders and bring a complex adversarial setup. Existing security sub-systems in cars (e.g., wireless keys, TPMS units) are also within reach.

Project implemented by

Research Group on Embedded Systems and Security, Department of Automation and Applied Informatics, Faculty of Automatics and Computers (UPT)

Implementation period:

Oct. 2015 – Sept. 2017

Main activities:

- Implementation and security analysis of cryptographic functions on automotive grade embedded devices, e.g., AUTOSAR compliant cryptographic libraries,
- Design and analysis of cryptographic protocols for wired in-vehicle networks, e.g., CAN bus, J1939, FlexRay, etc.
- Design and analysis of cryptographic protocols for wireless in-vehicle connectivity, e.g., RF keys, TPMS systems, etc.
- Implementation of an experimental platform for security critical subsystems inside the car: communication buses linking various ECUs with potentially insecure third-party devices (e.g. infotainment units)
- Risk analysis and security implications within new automotive paradigms: optimized traffic flows, vehicle-to-vehicle communications, etc.

Results:

- Comprehensive performance analysis of cryptographic primitives on automotive-grade controllers
- Analysis of fingerprinting and randomness extraction mechanism from SRAM state
- Design of new security solutions for wireless vehicle access
- Design of new security solutions for the CAN bus
- Security analysis and fixes for the J1939 commercial-vehicle bus protocol
- Analysis of traffic models with adversarial vehicle behavior
- Risk analysis and security implications for attacks on BCM units

Applicability and transferability of the results:

Various applications in the automotive industry for securing critical vehicular systems and networks, e.g., wireless keys, CAN bus, ECU fingerprinting, etc.

Financed through/by

Romanian National Authority for Scientific Research and Innovation (CNCS-UEFISCDI) Project No. PN-II-RU-TE-2014-4-1501

Research team

Habil. PhD. Eng. Bogdan Groza – director
Phd. Eng. Stefan Murvai (postdoctoral researcher)
Phd. Eng. Horatiu Gurban (postdoctoral researcher)
Eng. Diana Pop (PhD student)
Eng. Catalin Briciu (PhD student)
Eng. Tudor Andreica (student)
Eng. Alexandru Matei (student)
Inf. Roxana Farcasescu (PhD student)

Contact information

Assoc. Prof. Bogdan GROZA, PhD
Faculty of Automatics and Computer,
Bd. V. Parvan, No. 2, 300236, Timisoara
Phone: (+40) 256 403242
E-mail: bogdan.groza@aut.upt.ro
Web: <http://www.aut.upt.ro/~bgroza/Projects/cSEAMAN>

LEARNING TECHNIQUES FOR IMPROVING CONTROL SYSTEMS PERFORMANCE USING MODEL-FREE APPROACHES

Goal of the project:

The main objective of this proposal is to develop the necessary tools, algorithms and theoretical framework in order to induce the learning-predictive behavior for control systems using model-free control approaches. Several reference input-controlled output behaviors are memorized as primitive tasks inside a library. The primitives are used in predicting the optimal behavior of the control system when a new complex task is to be executed. A planning mechanism similar to a brain will be built in order to achieve this task.

Short description of the project:

The proposed techniques endow control systems with learning and planning features.

Project implemented by

Department of Automation and Applied Informatics of Politehnica University of Timisoara
<http://mbradac.info/te2015.html>

Implementation period:

2015-2017

Main activities:

- Improvement of data-based (or data-driven) techniques and their combination for obtaining improved capabilities.
- Development and validation of a primitive-based learning and planning strategy for feedback control systems.
- Validation of the proposed theoretical approaches on real-world processes such as laboratory equipments.
- Dissemination of research results in highly visible journals and conferences.

Results:

- 4 papers published in Thomson Reuters Web of Science journals with impact factors;
- 8 papers published in conference proceedings (to be indexed in international databases (ISI, IEEE Xplore, INSPEC, Scopus, DBLP));
- 1 book chapter published in a Springer-Verlag volume.

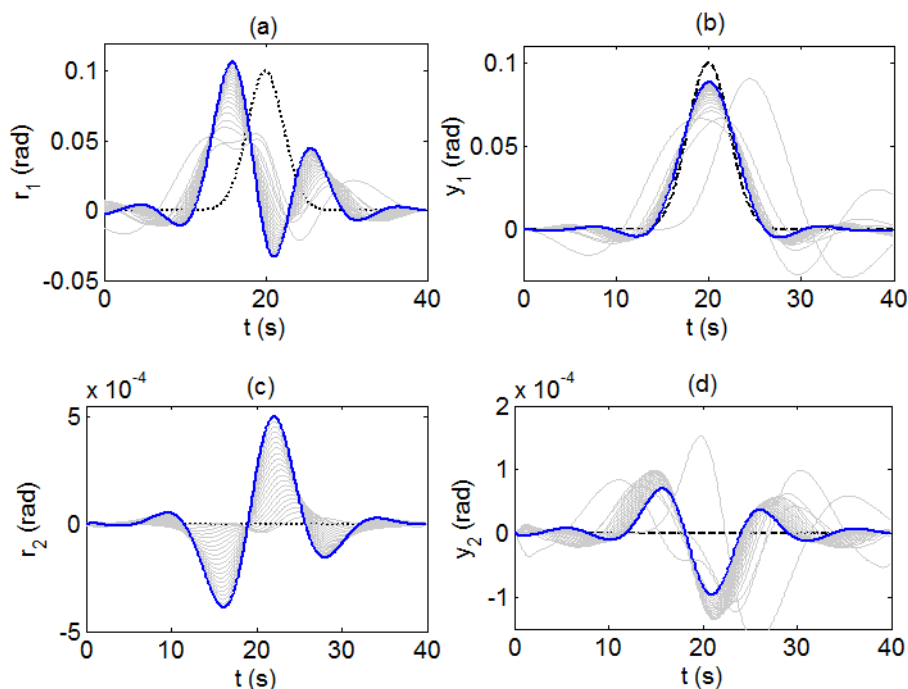

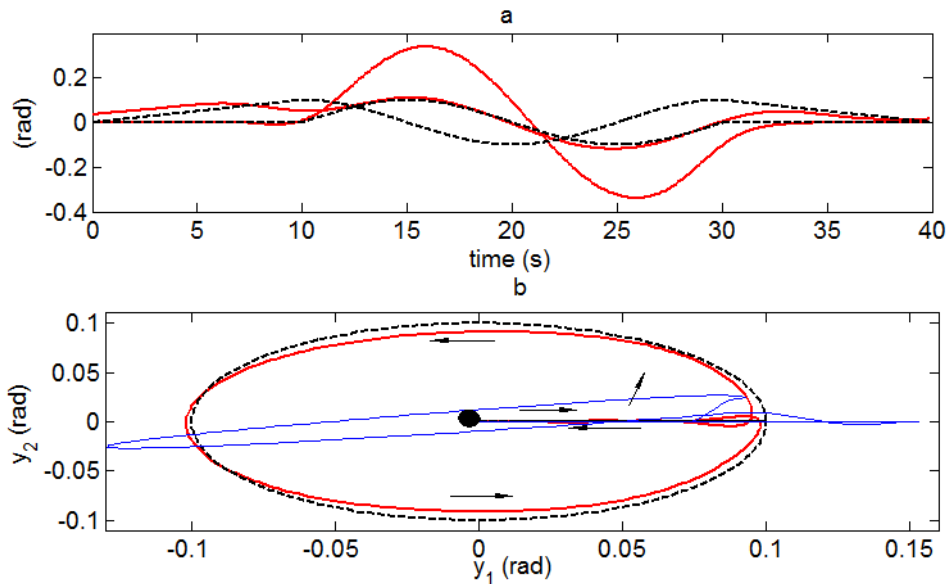

Applicability and transferability of the results:

Owing to the generality of the proposed theoretical framework, the primitive-based learning and planning approach for achieving optimal behavior can be applied to various (feedback) control systems such as mechanical, electrical, chemical, biological, or combinations of the above, in order to enhance them with optimal behavior ability in situations or scenarios never seen before. Thus, they imitate the living organisms. The results also connect several perspectives from the areas of feedback control and machine learning.

Financed through/by

Executive Agency for Higher Education, Research, Development and Innovation Funding (UEFISCDI), Bucharest, Romania.

Research Center

Automatic Systems Engineering Research Centre (CCISA)
<http://www.aut.upt.ro/centru-cercetare/index.EN.php>

Research team

Lect. Dr. Ing. Mircea-Bogdan Rădac - director, principal investigator
 Prof. Dr. Ing. Radu-Emil Precup - senior staff member
 Assist. Lect. Dr. Ing. Alexandra-Lulia Szedlak-Stănean - post doc
 M.Sc. Dipl. Ing. Raul-Cristian Roman - Ph.D. student
 M.Sc. Dipl. Ing. Constantin Purcaru - Ph.D. student

Contact information

Lect. Mircea-Bogdan RADAC, PhD
 Politehnica University of Timisoara,
 Department of Automation and Applied Informatics,
 Bd. V. Parvan 2, 300223 Timisoara, Romania
 Phone: (+40) 256 403240
 Fax: (+40) 256 403214
 E-mail: mircea.radac@upt.ro
<http://www.mbradac.info>

TIME AND ENERGY EFFICIENT FRAMEWORK FOR INTER-OPERATION OF SMART DEVICES (TEEFIOS)

Goal of the project

Development of an integrated real-time and energy efficient inter-operation framework for networks of smart sensors and devices - TEEFIOS.

Short description of the project

- Wireless networks of sensors and smart devices (WSN) are an extremely interesting topic, at the confluence of engineering fields with enormous impact on worldwide society: digital networks, wireless communications, and miniature embedded digital devices.
- Aware of the severe requirements and challenges raised by current applications in this area, we propose a new paradigm - Time and Energy Efficiency (T: or TEE).

The main proposed objectives focus on three distinct layers:

- (a) T:Node, a hardware-software environment and methodology for designing and assessing real-time behavior and efficient energy consumption of embedded devices,
- (b) T:YNet, a system for the development and analysis of TEE communication in wireless ad-hoc networks, and
- (c) T:PIlot, a methodology for the power management of the entire network. An integrated set of tools, benchmarks and databases will also be created to help advanced developers and researchers in the WSN area apply the TEE paradigm to applications with high impact.

Project implemented by

- DSPLabs - Digital Signal Laboratories Timisoara, Department of Computer and Software Engineering, Politehnica University of Timisoara.

Implementation period

01.10.2015 - 30.09.2017 (24 months)

Grant value

548850 RON (~123337 EUR)

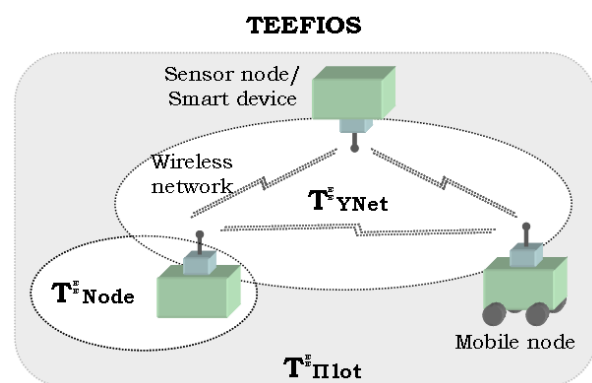

Main activities

- Energy consumption model and taxonomy for smart devices;
- Energy optimization real-time scheduling mechanism for smart devices;
- Methodology for node-level energy consumption assessment;
- Real-Time MAC protocol for ad-hoc wireless networks;
- Flexible real-time wireless module for smart devices;
- Framework for real-time communication in WSNs;
- Global power management methodology for networks of smart devices;
- Case studies to validate the TEEFIOS framework;
- Integrated set of databases and web-based tools;
- Information exchange, results dissemination and publication.

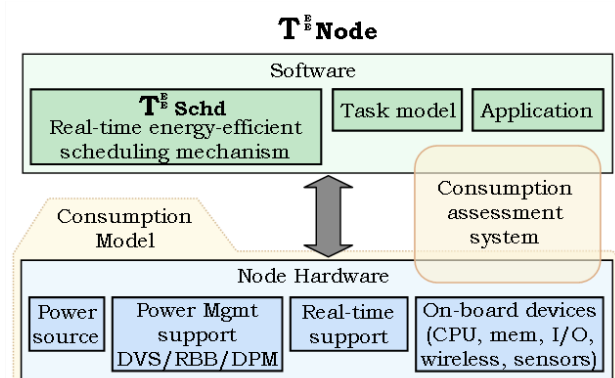

Results

- Integrated set of consumption models for smart devices;
- T:Schd, a real-time scheduling technique which optimizes energy consumption;
- Hardware/software methodology for the consumption evaluation of smart devices;
- Database with the energy efficiency evaluation and classification results for different types of smart devices;
- Real-time MAC protocol for ad-hoc wireless networks;
- Functional prototype of a flexible real-time wireless module for smart devices;
- A framework and a set of metrics for the evaluation of real-time wireless communication applications;
- A simulation testbed to evaluate the scalability of time and energy efficient WSN applications;
- T:Plot, a global power management methodology for networks of smart devices;
- A collection of case studies that demonstrate the validity of the proposed framework and its individual components;
- An integrated set of web and database tools for public-level information and access to the TEEFIOS framework services.

Applicability and transferability of the results

- The real-time and energy efficient interoperation framework, along with the associated tool set and databases, will be of valuable use to the advanced developers and researchers in the field of wireless sensor/smart device networks.
- The results of this project will help them apply the TEE paradigm to applications with high impact in scientific, social, economic and environmental areas, such as: disaster recovery, smart buildings and structures, environment monitoring, smart energy grids and metering, robotic collectives, industrial process control, smart vehicles and transportation, security and surveillance.

Fields of interest

- Real-time systems;
- Energy efficiency;
- Sensors and smart devices;
- Wireless communication;
- Ad-hoc networks.

Financed through/by

UEFISCDI, Romanian Ministry of Education and Research, Bucharest, Romania.

Research team

Project director:
Prof. Dr. Eng. Mihai V. Micea

R&D team:
Prof. Dr. Eng. Vladimir Cretu,
A/Prof. Dr. Eng. Dan Pescaru,
Lect. Dr. Eng. Răzvan Cioargă,
T/Assist. Dr. Eng. Valentin Stângaciu,
T/Assist. Dr. Eng. Cristina Stângaciu,
PhD Stud. Eng. Lucian Ungurean,
Eng. Claudia Micea,
Eng. Adriana R. Tirnovan.

Contact information

Prof. Mihai MICEA, PhD
Department of Computer Science
Address: Str. Bd. Vasile Pârvan, No. 2, RO300223, Timisoara,
Phone: (+40) 256 403271
Fax: (+40) 256 403214
E-mail: mihai.micea@upt.ro
Web: <http://dsplabs.cs.upt.ro/grants/teefios/>

DEVELOPMENT OF URBAN GREEN SPACE MONITORING TECHNIQUE WITH REMOTE SENSING AND ITS APPLICATION - COMPARATIVE STUDY TIMISOARA - ROMANIA AND BEIJING - CHINA

Goal of the project

The project aims to study the techniques used for monitoring urban green space by means of high resolution remote sensing data to support the application of high remote sensing in urban mapping and feature extractions. Other objectives refer to build information model to convert spatial and spectral information from remote sensing data to useful information, to evaluate urban environment by the analysis of the spatial configuration of urban buildings and urban green space, to promote scientific understanding of the interaction among buildings, green space and human beings.

Short description of the project

A city is the important area of earth's surface material, energy, and information exchanging; also it is the centre in national, regional political, economic, scientific and cultural aspects. Remote sensing imagery enables rapid and efficient quantification urban eco-environment and it gives a new insight for urban environmental research.

Project implemented by

Politehnica University of Timisoara, Civil Engineering Faculty, Land Measurement and Cadastre Branch (UPT) and Institute of Remote Sensing and Digital Earth, Chinese Academy of Sciences.

Implementation period

September 2016 – December 2017

Main activities

1. Propose image classification method and urban features extraction algorithm.

- Generation of the Normalized Height Model (NHM)
 - (1) Collection of LiDAR data on urban areas.

- (2) Collection of DEM (Digital Elevation Model) on urban areas.
- (3) Generation of DSM (Digital Surface Model) from LiDAR data
- (4) Generation of the Normalized Height Model by subtracting the DEM from the DSM

- Image segmentation algorithms
 - (1) Design of a robust segmentation algorithm for urban feature segmentation
 - (2) Segmentation accuracy assessment
- Extraction of Urban Buildings.
 - (1) Building mapping
 - (2) Generation of Building Height model
- 3D modeling of urban trees using LiDAR.
 - (1) Urban green mapping
 - (2) Tree detection and the 3D modeling of the urban trees.
- Urban green mapping using Multi-spectral images
 - (1) Machine learning techniques for classification of urban green
 - (2) Shadow detection and removal
 - (3) Accuracy assessment

2. Develop urban green space index to observe the urban green space at both horizontal and vertical dimensions.

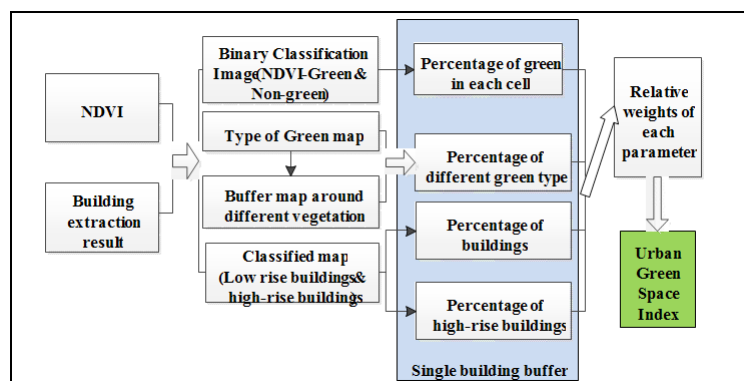

Results

The project is intended to contribute to the knowledge in remote sensing domain and make progress in using the following techniques:

1. Techniques for multi-source remotely sensed data fusion;
2. Development of new classification algorithms for urban mapping using high resolution remotely sensed data;
3. 3D modeling of urban features based on high resolution remotely sensed data;
4. Development of an urban green space evaluation model;
5. Studying the urban green space parameters quantitative retrieval technology.

Applicability and transferability of the results

1. Develop an evaluating system for measuring the quality of the urban environment using remote sensing technology.
2. Probe the relations between green space and other environmental elements based on the space-time multi-scale urban green space model.
3. Demonstrate the urban green space monitoring technology among different cities.

Financed through/by

PN III - Unitatea Executivă pentru Finanțarea Învățământului Superior, a Cercetării, Dezvoltării și Inovării

Research Centre

Research Centre of Infrastructures for Construction and Transportation

Research team

Assoc.prof. Sorin HERBAN, PhD – Principal Investigator –UPT
Prof. Meng Qing-Yan, PhD - Principal Investigator –RADI

UPT Team:

Prof. Carmen GRECEA, PhD;
Beatrice TESILA (Vilceanu), PhD;
Adrian ALIONESCU PhD.

Contact information

Assoc. Prof. Sorin HERBAN, PhD
Faculty of Civil Engineering/CCTFC
Address: Str., Ioan Curea 1A, Timisoara
Phone: (+40) 256 403978
Mobile: (+40) 722223952
E-mail: sorin.herban@upt.ro

NANO-ENHANCED ELECTROCHEMICAL GREEN TECHNOLOGY FOR ADVANCED INTEGRATED WATER TREATMENT AND QUALITY CONTROL

Goal of the project:

The main goal of the project is to develop the electrochemistry application field in water treatment and quality control, by creating the right framework for achieving the high research level.

This project aims to explore potential use of nano-enhanced electrochemical dual green technology to improve access to clean water.

Short description of the project

Based on the results obtained in our previous studies for the oxidation of pollutants in aqueous solutions for their degradation and/or their detection on the carbon-based electrodes, specific objectives have been set in this project:

1. Elaboration and manufacturing of some new electrodes types based on nanostructured carbon and Ag/Cu/TiO₂ modified zeolite with enhanced electro(photo)-catalytic activity;
2. Manufacturing, design and geometry conditions of electrodes for degradation and monitoring applications;
3. Setting-up the optimal conditions for the degradation and mineralization of priority organic pollutants (POPs) from water;
4. Elaboration of the electrochemical detection scheme;
5. Integration of the electrochemical detection methods within the control of the degradation and mineralization of POPs in aqueous solutions.
6. Development of a new nano-enhanced electrochemical green dual technology for integrated water treatment and control.

Project implemented by

UEFISCDI

Implementation period

2011 - 2016

Main activities

1. Elaboration of new composite materials based on carbon nanotubes (CNT)/carbon nanofibers (CNF) in epoxy matrix as electrode materials for oxidation of POPs from water;
2. Characterization of new composite materials based on CNT/CNF in epoxy matrix and electrode design;
3. Composite electrode obtaining and selection for application in degradation and/or detection of POPs from water;
4. Assessment of electro(photo)catalytic performance of the selected electrodes in advanced degradation/mineralization of POPs;
5. Assessment of the electroanalytical performance of the electrode in detection of POPs from water. Optimization of the electroanalytical method;
6. Integration and optimization of the electrode materials and electrochemical techniques in advanced wastewater treatment and process control.

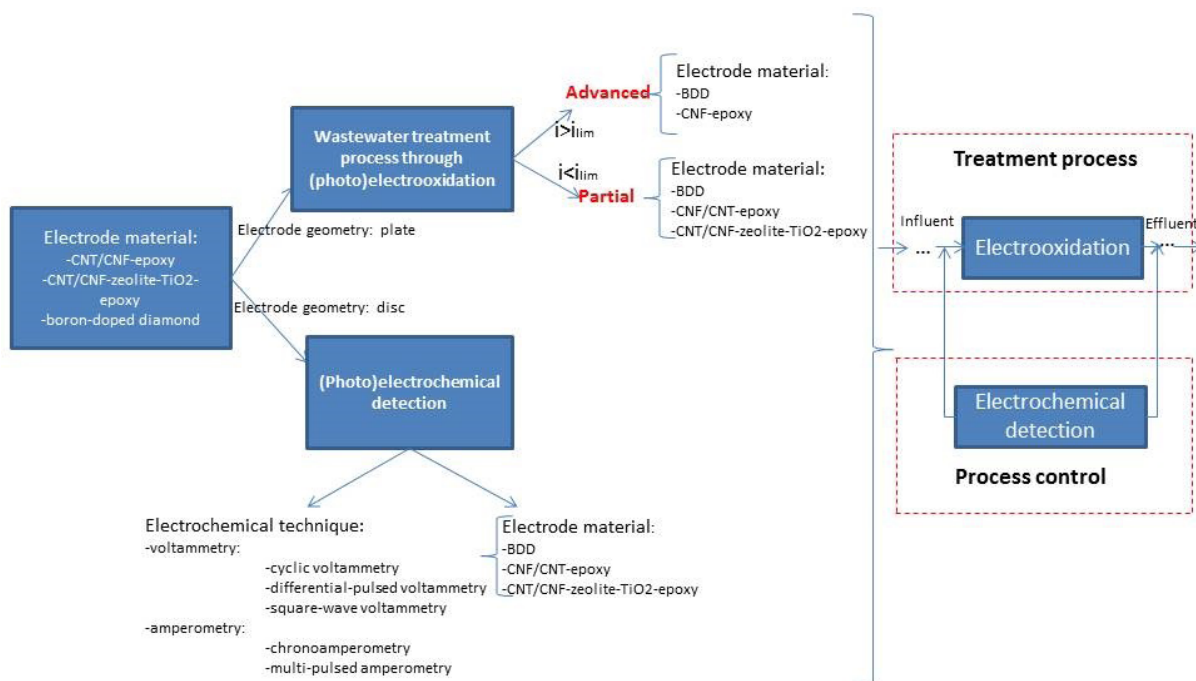

Results

- Comparative monitoring of optimized electrochemical treatment of priority organic pollutants from water using the electrochemical detection and conventional methods;
- Optimization of the composition of the electrode material and the electrochemical technique for integrative electrochemical degradation and process control;
- Published papers;
- Patent application " Electrode and method for fast electrochemical detection of arsenic (III) from aqueous solution"

Applicability and transferability of the results

The nano-enhanced electrochemical green dual technology could be scaled and tested for application at pilot level in water treatment.

Financed through/by

Executive Unit for Financing Higher Education, Research, Development and Innovation - UEFISCDI

Research team

Florica Manea - director
 Rodica Pode - senior researcher
 Aniela Pop - researcher
 Anamaria Baciu - researcher assistant
 Sorina Motoc - researcher assistant

Contact information

Prof. Dr. Eng. Florica Manea
 florica.manea@upt.ro
<http://www.3waves.ro/id165upt/>

INTEGRATED SYSTEM FOR REDUCING ENVIRONMENTAL AND HUMAN-RELATED IMPACTS AND RISKS IN THE WATER USE CYCLE

Goal of the project:

The main goal of the project is to develop and implement an integrated system of innovative technologies and management instruments for reducing environmental impacts and associated human health risks caused by water quality aspects in the entire water use cycle: water abstraction, treatment, distribution, use, wastewater collection, wastewater treatment and discharge and reuse.

Short description of the project

The specific objectives were defined at the level of whole water usage cycle:

1. Development of specific instruments for the identification, quantification and control of environmental impacts and risks, over the water use cycle, applied to regional water operators;
2. Development of the capacity of collaboration and knowledge transfer between the universities and the regional water operators in Iasi and Timis counties for the control of the environmental impacts and human health risks in the water use cycle;
3. Development of the research and institutional capacities of the universities and water regional operators in Iasi and Timis counties for facilitation of the further cooperation at national and international scale;
4. Development of capacities and competitiveness of Romanian researchers and staff of regional water operator, as well as of the national partnerships contributing to environmental sustainability.

Project implemented by

- SC Aquatim SA Timisoara
- SC Apavital SA Iasi

Implementation period

2012 – 2016

Main activities

1. Integrated evaluation of the water use cycle;
2. Studies on impact and risk minimization through innovative water treatment process (removal of nitrate, nitrite and natural organic matter);
3. Studies on impact and risk minimization through innovative wastewater treatment processes (removal of priority organic pollutants);
4. Pilot-scale studies on impact and risk minimization in water and wastewater treatment for reuse.
5. Development and testing of integrated management instruments for impact and risk prediction and minimization over the water use cycle;

Results

- Schematic flow for the flexible pilot plant for the drinking water treatment;
- Workshop and training dedicated to experts of regional water operators
- Flexible pilot plant for the drinking water treatment
- Patent application "Installation and process for drinking water treatment"



Applicability and transferability of the results

Two regional water operators, i.e. Aquatim and Apavital are involved in this project in order to test and apply innovative technologies for water and wastewater treatment in direct relation with specific water quality problems.

Financed through/by

Executive Unit for Financing Higher Education, Research, Development and Innovation - UEFISCDI

Research team

Florica Manea - partner responsible
Rodica Pode - senior researcher
Laura Coheci - researcher
Aniela Pop - researcher
Anamaria Baciu - researcher as.
Sorina Motoc - researcher as.
Magdalena Ardelean - researcher as.
Agnes Jakob - researcher as.

Contact information

Prof. dr. eng. Florica Manea
florica.manea@upt.ro
<http://www.ch.tuiasi.ro/cercetare/parteneriate/watuser/Home.htm>

Main activities

- Synthesis and characterization of AgNWs with controlled aspect ratio (2013).
- Development and characterization of transparent conductive electrodes on flexible substrates using AgNWs and assessment of their electrical and optical properties (2014)
- Synthesis and characterization of indium and tin nanoparticles (2014)
- Synthesis and characterization of AgNWs modified with tin and indium nanoparticles (2015)
- Preparation of electroconductive inks based on AgNWs (2015)
- Optimization of AgNWs-based flexible, transparent and conducting electrodes to increase diffuse transmittance / resistance ratio (2016)
- Deposition of a conducting polymer on previously manufactured electrodes (2016)
- Construction of dye-sensitized solar cells using AgNWs-based transparent and conducting electrodes (2016)

Results

Patent application

- R. Bănică, A. Kellenberger, D. Ursu, L. Cseh, P. Linul, N. Vaszilcsin, Method for the synthesis of silver nanowires coated with low melting point metal nanoparticles

ISI publications:

- R. Bănică, D. Ursu, T. Nyari, A. Kellenberger, Two step polyol-solvothermal growth of thick silver nanowires, *Mat Lett* – accepted
- R. Bănică, D. Ursu, T. Nyari, A. Kellenberger, Polyol synthesis of silver nanowires in the presence of silver chloride, *Optoelectron Adv Mat* – under review
- R. Bănică, D. Ursu, P. Svera, C. Sarvaş, S.F. Rus, S. Novaconi, A. Kellenberger, A.V. Racu, T. Nyari, N. Vaszilcsin, Electrical properties optimization of silver nanowires supported on polyethylene terephthalate, *Partic Sci Techn*, 34 (2016) 217-222
- D. Ursu, R. Bănică, N. Vaszilcsin, Photovoltaic performance of (Al, Mg)-doped CuCrO₂ for p-type dye-sensitized solar cells application, *Nanosci Nanotech* 6 (2016) 71-76

Applicability and transferability of the results

The manufacture of silver nanowires coated with metal nanoparticles with low melting points is expected to have an important economic impact and is subject of a patent application.

The transparent, flexible and conductive electrodes based on silver nanowires have been successfully tested in dye sensitized solar cells. Conductive inks based on silver nanowires may be used not only for flexible solar cells but also for other optoelectronic devices, such as flexible LEDs, organic thin film transistors, organic lasers and photo detectors, electronic paper and disposable sensors.

Financed through/by

UEFISCDI - Executive Agency for Higher Education, Research, Development and Innovation Funding, Programme IDEAS, Exploratory Research Projects.

Research centre

Research Centre for Inorganic Materials and Alternative Energies

Research team

Assoc. Prof. Andrea Kellenberger – project manager
Prof. Nicolae Vaszilcsin – senior researcher
Terezia Nyari – senior researcher
Liliana Cseh – senior researcher
Radu Nicolae Banica – postdoctoral researcher
Cosmin Locovei – postdoctoral researcher
Radu Baies – postdoctoral researcher
Mircea Laurentiu Dan – PhD student
Alin Bucur – PhD student
Daniel Horatiu Ursu – PhD student
Paul Cristian Capota – master student

Contact information

Assoc. Prof. Andrea KELLENBERGER, PhD
Faculty of Industrial Chemistry / Department of Applied Chemistry and Inorganic Compounds and Environmental Engineering
Address: Parvan Boulevard, No. 6, RO300223, Timisoara
Phone: (+40) 256 404 178
E-mail: andrea.kellenberger@upt.ro
Web: <http://chim.upt.ro/ro/cercetare/proiecte-de-cercetare/147-pn-ii-id-pce-2012-4-0398>

NOVEL NANOMATERIALS BASED STRATEGIES FOR INNOVATIVE SENSING SYSTEMS APPLIED IN SAFETY AND QUALITY CONTROL OF NATURAL JUICE

Goal of the project

The main goal of the project is to contribute greatly exploratory research in developing new electrode materials with advanced properties linked to the original exploitation of certain electroanalytical techniques envisaging smart strategies for food quality control and safety.

Short description of the project

This research proposal envisage an important contribution to food quality control and safety through elaboration of new strategies for qualitative and quantitative evaluation of the potentially harmful compounds (residues of pesticides and preservatives) from natural juices, by involving well-controlled nanomaterials in the development of innovative detection systems with improved electroanalytical performances. Detection systems will be based on new glassy carbon sensors modified with carbon nanostructures and metallic nanoparticles that will allow the elaboration of selective/simultaneous detection protocols for preservatives and pesticides, potentially present in juices. Sensor surface modification with membrane will permit selective access of target analytes only to carbon nanostructures, allowing a specific concentration on the electrode surface.

Expected performance of detection strategies proposed by project open the perspective of practical applications in the direction of their use by regulatory bodies for food quality control or even by natural juices producers, either before processing of the potentially contaminated fruits with pesticide residues, either on the production flow or final product quality evaluation/monitoring.

Project implemented by

Faculty of Industrial Chemistry and Environmental Engineering

Implementation period

01.10.2015 - 30.09.2017

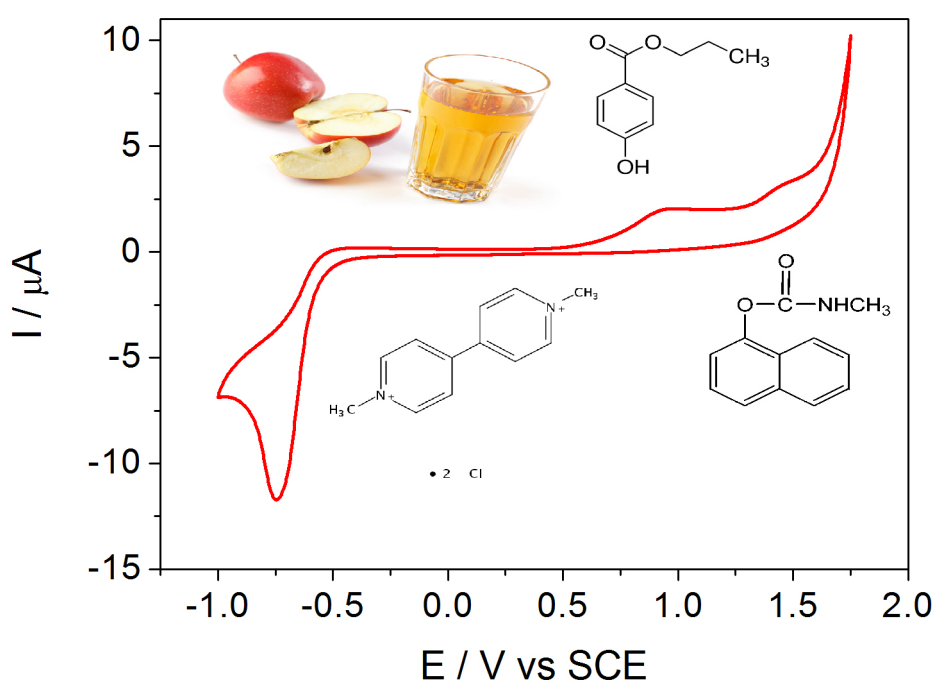

Main activities

- i. Obtaining new sensors based on nanostructured carbon by modifying classic glassy carbon (GC) electrode with CNT/CNF/graphene/fullerene characterized by structural, morphological and electrochemical specific properties suitable for electrochemical detection applications.
- ii. Sensors functionalization with metallic nanoparticles (Cu/Ag/Au/Pt) by advanced electrochemical (multiple-pulsed amperometry – MPA, chronoamperometry – CA and cyclic voltammetry - CV) with morpho-structural and electrochemical properties characteristic to the electrochemical detection applications.
- iii. Elaboration of procedure/detection schemes for target analytes from preservatives and pesticide residues categories based on obtained new sensors and their optimization.
- iv. Development of detection techniques with intermediate preconcentration step on electrode surface for harmful compounds at trace levels from test sample, exploiting adsorbent properties of nanostructures carbon.
- v. Elaboration of simultaneous and/or selective detection procedures/schemes of selected target analytes, by sensors modification with selective membranes.
- vi. Procedures checking through detection strategies elaboration for specific applications in juices quality control and safety.

Results

- New sensors modified with nanostructured carbon (carbon nanotubes (CNT), carbon nanofibers (CNF), fullerenes and graphene) and/or metallic nanoparticles (Cu / Ag / Au / Pt) for natural juices safety and quality control applications.
- Protocols for selective/ simultaneously detection of preservatives and pesticides potentially present in natural juices.

Applicability and transferability of the results

New sensors modified with nanostructured carbon (carbon nanotubes (CNT), carbon nanofibers (CNF), fullerenes and graphene) and/or metallic nanoparticles (Cu / Ag / Au / Pt) for natural juices safety and quality control applications.

Protocols for selective/ simultaneously detection of preservatives and pesticides potentially present in natural juices.

Financed through/by

Executive Unit for Financing Higher Education, Research, Development and Innovation - UEFISCDI

Research centre

Research Institute for Renewable Energy – ICER TM
Research Centre in Environmental Science&Engineering

Research team

Assist. Prof. Aniela POP, PhD
Prof. Florica MANEA, PhD
Postdoctoral researcher Anamaria BACIU, PhD
Postdoctoral researcher Agnes JAKAB, PhD
PhD. student Adriana (BĂLĂȘOIU) FLUERAȘ
PhD. student Ianina BÎRSAN

Contact information

Assist. Prof. Aniela POP, PhD
Department of Applied Chemistry and Inorganic Compounds and Environmental Engineering
Address: Bd. Vasile Pârvan, No. 6, RO 300223, Timisoara
Phone: (+40) 256 403 069
E-mail: aniela.pop@upt.ro
Web: <https://sites.google.com/site/sensojuice>

DEVELOPMENT OF NANOSTRUCTURED MAGNETIC COMPOSITES USED AS NANO-ADSORBENTS AND NANO-CATALYSTS WITH HIGH PERFORMANCE IN ENVIRONMENTAL APPLICATIONS

Goal of the project:

Developing new efficient synthesis variants of oxide nanoparticles in order to obtain nanomaterials, magnetic nanostructures based on iron oxides ($\gamma\text{-Fe}_2\text{O}_3$, Fe_3O_4 , ferrites spinels MFe_2O_4) with tailored properties for their use as nano-adsorbents and nano-catalysts for remediation of water.

Short description of the project:

Water pollution by heavy metals and organics has become a serious problem because of their extremely hazardous effects on humans and the ecological systems.

The present project is focused on the developing of nanostructured magnetic materials based on iron oxides (magnetite, maghemite, spinel ferrites) with special properties (magnetic properties, specific surface area and morphology) that can be used as high performance nano-adsorbents and nano-catalyst for the removal of inorganic (metals ions: Cd(II), Pb(II), Cr(VI), Cu(II), Co(II), Zn(II)) and organic (dyes and phenols) pollutants from wastewaters. In order to achieve this we will develop new, original versions of the two unconventional synthesis methods of nanopowders and nanocomposites: solvothermal method and thermal decomposition of precursors. In order to develop high performance nanostructured magnetic oxides (iron oxides and ferrites) with high specific surface area, porosity and adequate magnetic properties composites like magnetic oxides/carbon will be synthesized by these methods, using different common carbon precursors in order to obtain low cost final materials. Also, the functionalization of surface will be performed with different organic modifiers in order to make the nanoparticles specific for certain applications.

Finally, the obtained iron oxides based magnetic nanostructures materials (oxides, ferrites and composites) will be tested as nanoadsorbants and catalyst for the removal of water pollutants.

Project implemented by

University Politehnica Timisoara

Implementation period:

01.10.2015-30.09.2017

Main activities:

I. Synthesis of magnetic oxide nanopowders (Fe_xO_y , MFe_2O_4) by new, original variants of solvothermal method and of thermal decomposition of the precursors and powders characterization.

A.I.1 Study of the influence of organic solvents' nature on the structure and morphology of the oxide particles obtained by solvothermal

method. Determination of the most appropriate solvent for the synthesis of a series of solvents which have not been reported in the literature.

A.I.2 Study of the influence of polyols nature and polyol: metal nitrates ratio and of the presence of surfactants on the structure, morphology, magnetic properties of nanopowders synthesized by the method of decomposition of precursors.

A.I.3 Characterization of materials obtained by thermal analysis, FT-IR spectroscopy, X-ray diffractometry, specific surface area and porosity measurements, Mosbauer spectroscopy, X-ray diffractometry, SEM, TEM electron microscopy, magnetic measurements.

A.I.4 Writing scientific report and disseminate the results through participation in an international conference. Making the project web page

II. Synthesis of the nanocomposites type $\text{Fe}_x\text{O}_y / \text{C}$ and $\text{MFe}_2\text{O}_4 / \text{C}$ by original synthesis methods and their characterization

A.II.1 Study of the influence of process parameters: temperature and autoclaving time on the structure, morphology and properties of synthesized nanocomposites

A.II.2 Study of the influence of organic solvents' nature on the structure and morphology of the oxide particles obtained by solvothermal method. Determination of the most appropriate solvent for the synthesis of a series of solvents which have not been reported in the literature

A.II.3 Study of the influence of initial oxide precursor: carbon precursor ratio on the carbon content of the composite.

A.II.4 Study of the influence of carbon precursor nature on the carbon content of composites with carbon and their morphology

A.II.5. The obtaining of composites by thermal decomposition of precursor method: influence of decomposition atmosphere, calcination temperature and time and of the presence of other carbon precursors in addition beside the polyol used as a reductant.

A.II.6 Characterization of the obtained nanocomposites by thermal analysis, FT-IR, X-ray diffractometry, the specific surface area and porosity measurements, Mössbauer spectroscopy, X-ray diffractometry, electron microscopy, SEM, TEM, magnetic measurements.

A.II.6 Writing scientific report and disseminate the results through participation in an international conference and publication of an ISI

article.

III. Testing of magnetic powders synthesized as adsorbent materials

and catalysts for removal of inorganic and organic pollutants in water
A.III.1 Testing of oxide nanopowders Fe_3O_4 , Fe_2O_3 , MFe_2O_4 compared to the corresponding nanocomposite Fe_3O_4/C , Fe_2O_3/C , MFe_2O_4/C as a metal ion adsorbents: Cd (II), Cr (VI), Pb (II), Cu (II), Ni (II), Co (II)

A.III.2 Testing of oxide nanopowders Fe_3O_4 , Fe_2O_3 , MFe_2O_4 compared to the corresponding nanocomposites Fe_3O_4/C , Fe_2O_3/C , MFe_2O_4/C as adsorbents for organic contaminants: colorants and phenolic compounds.

A.III.3 Testing of functionalized oxide powders as adsorbents for inorganic and organic pollutants studied. Study on the influence of nature of surface functional groups on pollutant removal efficiency

A.III.4 Testing of Fe_xO_y and MFe_2O_4 magnetic powders as catalysts for catalytic oxidative degradation of organic pollutants: dyes and phenolic compounds

A.III.5 Study the possibility of regeneration of the adsorbent material by controlled desorption of adsorbed species in different solvents or by changing the pH.

A.III.6 Study of adsorbent material reuse on its performance (maximum capacity of adsorption of pollutant removal efficiency). Proposing a technological schemes for use in remediation of water nanopowders

A.III.7 Preparing final scientific report. Dissemination of results: patent proposal preparation and submission and publication of 2 ISI papers..

Results:

Published papers:

1. Stoia M., Istrate R., Pacurariu C., Investigation of magnetite nanoparticles stability in air by thermal analysis and FTIR spectroscopy, Journal of Thermal Analysis and Calorimetry (2016) 125, 1185–1198

2. Stoia M., Pacurariu C., Istrate R., Barvinschi P, Locovei C., Thermoanalytical techniques: Excellent tools for the characterization of ferrite/SiO₂ nanocomposites and their precursors, Journal of Thermal Analysis and Calorimetry (2016) 125, 1249–1263,

3. Stoia M., Pacurariu C., Muntean E.C., Thermal stability of the solvothermal-synthesized MnFe₂O₄ nanopowder, Journal of Thermal Analysis and Calorimetry,

Conferences

1. Cornelia Muntean: The XXXVIII National Congress on Calorimetry, Thermal Analysis and Applied Thermodynamics (AICAT-GICAT 2016) Ischia (Naples), Italy, September 25-28, 2016

Cornelia Muntean, Marcela Stoia, Geza Bandur: Thermal evolution OF MnFe₂O₄ precursors obtained by co-precipitation in organic medium

2. Eliza Muntean: 25-th Symposium on Thermal Analysis and Calorimetry - Eugen Segal, Bucuresti, Romania, Februarie, 2016

Stoia M, Muntean Eliza, Pacurariu C, Study on thermal evolution of MnFe₂O₄/C composites synthesized by solvothermal method

3. Muntean Eliza: "New trends and strategies in the chemistry of advanced materials with relevance in biological systems, technique and environmental protection" 9th Edition, June 09-10, 2016

Muntean E., Stoia M., Pacurariu C. Solvothermal synthesis of manganese ferrite nanopowders using different surfactants

Applicability and transferability of the results:

This project will develop innovative and original solutions, both in terms of getting nanomaterials used as nano-adsorbents or nanocatalysts in wastewater treatment processes and in terms of regeneration of adsorbents / catalysts and their reintroduction in the process of treatment the waste water, so as to minimize the impact on the environment.

The project aims to find effective solutions as easy to achieve as practical and cheap for treatment of effluents loaded with ions of heavy metals and organic pollutants (dyes and phenols) using as adsorbents the magnetic oxide nanopowders to be obtained.

Financed through/by

Executive Agency for Higher Education Research, Development and Innovation Funding (UEFISCDI)

Research Center

Research Institute for Renewable Energy , University Politehnica Timisoara

Research team

Project leader: Lecturer eng. Stoia Marcela Elena, PhD

Senior researcher: Lecturer eng. Muntean Cornelia Veronica, PhD

Postdoctoral researcher: Lecturer. eng. Lupa Lavinia, PhD

Postdoctoral researcher : Assist. eng. Moaca Alina, PhD

PhD student: eng. Muntean Eliza

PhD student: eng. Gabor Andreea

Contact information

Lecturer. Marcela STOIA, PhD

Faculty of Industrial Chemistry and Environmental Engineering/
Department CAICAM

Address: Bvd. Vasile Parvan., No.6, 300223, Timisoara

Phone: (+40) 256 404158

Mobile:

E-mail: marcela.stoia@upt.ro

BIOCATALYST- CLICK CHEMISTRY DOWNSTREAMING TANDEM BASED INNOVATIVE KIT FOR OPTICALLY PURE FINE CHEMICALS SYNTHESIS

Goal of the project:

The project main objective is to develop an innovative kit for efficient and cost-effective sequential continuous flow large-scale (multigram) preparation of optically pure chiral building blocks useful for synthesis of pharmaceutical compounds and agricultural chemicals, based on the tailor-made immobilized lipases mediated kinetic resolution of various racemic substrates and a subsequent click chemistry like efficient downstreaming of the reaction mixture. Such an innovative approach of coupling kinetic resolution of a broad range of racemic substrates with click chemistry type downstreaming was not yet carried out.

Short description of the project

Biocatalysis is an important tool to implement new, efficient, selective, cost effective and greener technologies, defining a new strategy in the industry of the future. For industrial applications, the stability and reusability of the biocatalysts are important requirements which can be achieved by immobilization, improving also their activity and selectivity. Optimization of the biocatalytic function, as well as the biocatalytic process design became essential topics in industrial biotechnology.

In this project a chemo-enzymatic process which integrates several innovative steps in both biocatalytic and down streaming parts will be set up. The utilization of tailor-made biocatalysts in industrial processes is an innovative approach, technically comparable to the synthetic solutions but with higher economic benefits. The use of immobilized biocatalysts-click chemistry tandem will permit to design easily scaled-up continuous flow procedures for industrial manufacturing of the target compounds, underlining the economic relevance of the proposal.

Project implemented by

- Politehnica University of Timișoara - Project leader
- University "Babes-Bolyai" Cluj Napoca - Partner 1
- Natural INGREDIENTS R&D S.R.L - Partner 2

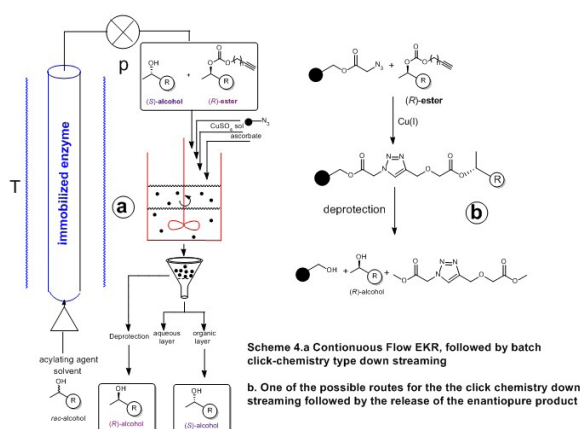

Implementation period

01.07.2014-30.06.2016

Main activities

1. Preparation of various precursors: (hetero)aryl-ethanols, hydroxy- and amino acids and synthesis of various propargylic esters as O- and N-acylating agents used in enzymatic kinetic resolution (EKR).
2. Development of optimal EKR and click-chemistry type downstreaming procedures.
3. Immobilization of lipases.
4. Development of the continuous flow procedure

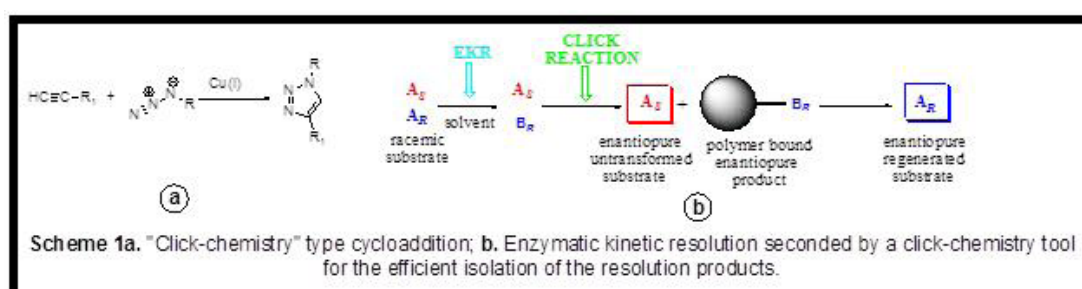

Results

1. Multi-gram amounts of various racemic compounds and various propargylic esters as acyl donors for the EKR;
2. Enantiomeric separation protocol for previously synthesized racemates, chromatographic protocols for testing the enantioselectivity of the enzymatic reactions;
3. Scientific article submitted to an ISI quoted journal;
4. Scientific presentation, published in the abstract book of an international conference;
5. Experimental protocol of down streaming procedures;
6. Immobilization protocols and analysis procedures for tailor-made immobilized lipases;
7. Integrated EKR-click-chemistry type down streaming procedure;

Applicability and transferability of the results

The obtained kit, as well as the high-value products, will be marketable, but the process will be appropriate for further scaling-up, depending on the customer demands.

In the forthcoming period, a strong impact of industrial biotechnology can be expected in the fine chemicals sector. As lipases demonstrated the highest application capability among industrial enzymes, the efforts to improve their operational stability and catalytic efficiency led to a remarkable development of the immobilization methods. Certainly, the manufacturing of high value optically active compounds represents the main large-scale process where biocatalysis with lipases will replace the presently employed procedures.

Enzymatic kinetic resolution (EKR) of the racemic mixtures represents the most efficient way to obtain high optical purity compounds. However, in large scale EKR an important challenge remains the isolation and purification of the products, which generally involves expensive and laborious physical procedures, decreasing the global process yields and the optical purities of the isolated compounds.



To the best of our knowledge the use of click chemistry involving large carriers, as a tool for easy EKR product separation is still unknown and it could be a practical solution for the efficient large scale isolation and purification of the enzymatic resolution products. Performing the click reaction between a preactivated polymer and one of the appropriate functionalized reaction products in the enzyme free reaction mixture obtained by EKR, would circumvent the tedious isolation and purification procedures.

Financed through/by

Executive Agency for Higher Education, Research, Development and Innovation Funding, UEFISCDI

Research team

Prof. Francisc Peter, PhD
Assist. Prof. Cristina Paul, PhD
Valentin Badea, PhD
Emese Biro Phd
Eng. Anamaria Todea
Eng. Adinela Cimporesu
Eng. Claudiu Marcu

Contact information

Prof. Francisc PETER, PhD
Department of Organic and Natural Compounds Engineering
Address: Carol Telbisz Street, No. 6, RO300001, Timisoara
Phone: (+40) 256 404216
Mobile: (+40) 745637530
E-mail: francisc.peter@upt.ro
Web: http://chim.upt.ro/Facultatea-de-Chimie-Industrială-si-Ingineria-Mediului_PN-II-PT-PCCA-2013-4-0734_qqpYW.html

NEARLY ZERO ENERGY BUILDING AND PASSIVE HOUSE – SUSTAINABLE SOLUTIONS FOR RESIDENTIAL BUILDINGS

Goal of the project

The idea of this project arose from the need to develop energy efficient solutions that reduce the energy need in the Romanian building sector. The main goal of the NEZEBUILD research project is related to the design and detailing of technical solutions in order to achieve the nearly zero energy building standard, resulting in the validation of such designs through extensive monitoring. Design, detailing and execution include the construction elements, finishes and installations system.

Short description of the project

A pilot project was developed consisting in a residential building composed of two detached houses, the passive house (PH) standard and the nearly zero energy building standard (NZEB). The two houses are equipped with monitoring systems. All project activities aim at developing a recommendation design guide regarding PH and NZEB based on experimental research.

Project implemented by

Project Partnership comprising Politehnica University of Timisoara - CCI Department and Arhitim.

Implementation period

2012 - 2016

Main activities

- Design and detailing of NZEB system including procurement of materials and equipment.
- Design of the monitoring system and set-up of equipment and accessories for NZEB
- Evaluation of monthly energy consumption for the two houses. Evaluation of main consumption, energy produced and consumed from renewable sources.
- Overall investment cost assessment and lifetime of the building. Analysis of the overall cost of the investment.
- Evaluation of elements with significant impact in terms of environmental protection
- Lifecycle assessment using specialized software SimaPro - LCA with different scenarios.
- Elaborating a comparative PH vs. NZEB study on energy efficiency.
- Dissemination of recommendations and general rules for implementing energy efficient residential houses in the Romanian temperate climate.

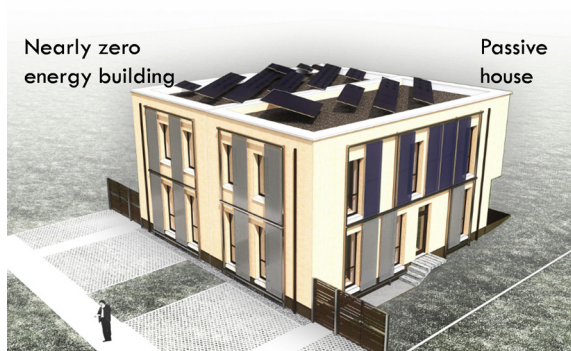

Results

The research project ended in December 2016. The research initiated through this project is continued by the research team. The monitoring process of the two houses continues and also the processing and interpretation of the obtained data. Real time monitoring graphs from the two houses can be viewed online at the address <http://www.sdac.ro/site/archives/category/monitoring>. The results of the project were published in several scientific paper among which a scientific paper was published in a prestigious scientific journal in the energy efficiency domain. Also, based on the experience from this project, the research team developed a series of guidelines and recommendations useful in the design of energy efficient buildings.

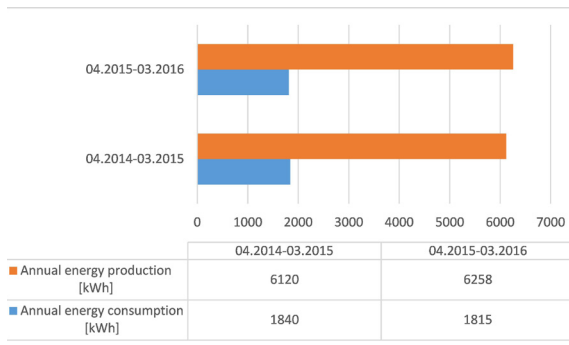

Applicability and transferability of the results

The topic of the project is closely related with the increasing concern of nowadays society on reducing the energy consumption in buildings. The targeted groups of the project are scientist, specialists in the energy efficiency field and stakeholders. The project deliverables will assure the transfer of knowledge, generating further „know-how” for scientific community and for practicing specialists (civil and environmental engineers, electrical and energy engineers, architects, technicians).

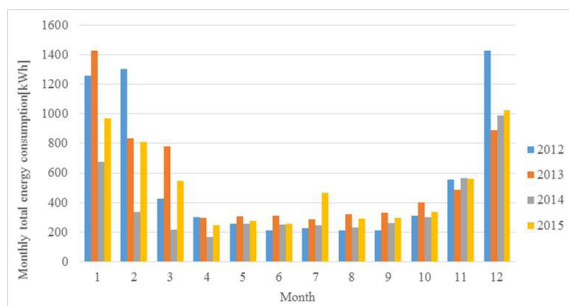

Financed through/by

This work was supported by a grant of the Romanian National Authority for Scientific Research, CNDI – UEFISCDI, project number PN-II-PT-PCCA-2011-3.2-1214-Contract 74/2012.

Research centre

Research Centre for Retrofitting of Constructions – RECO, within CCI Department

Research team

PROJECT MANAGER:
Prof. Daniel DAN, PhD

U.P.T. TEAM MEMBERS:
Prof. Valeriu STOIAN, PhD
Prof. Tamas NAGY-GYORGY, PhD
Lect. Sorin-Codrut FLORUT, PhD
Lect. Cosmin DAESCU, PhD
Assist. prof. Simon PESCARI, PhD
Assist. prof. Calin SEBARCHEVICI, PhD

ARHITIM TEAM MEMBERS:
Dan STOIAN, PhD student
Cristina TANASA, PhD student

Contact information

Prof. Daniel DAN, PhD
Department of Civil Engineering and Building Services
Str. Traian Lalescu, No.2, RO300223, Timisoara
Phone: (+40) 256 403 005
E-mail: daniel.dan@upt.ro

STRUCTURAL CONCEPTION AND COLLAPSE CONTROL PERFORMANCE BASED DESIGN OF MULTISTORY STRUCTURES UNDER ACCIDENTAL ACTIONS (CODEC)

Goal of the project

The main goal of the project is the development of a design methodology for mitigation of progressive collapse of multi-storey steel frame buildings against extreme load events caused by both natural and human-made hazards.

Short description of the project

During their designed lifetime, buildings can be affected by accidental actions, which might result in structural collapse, loss of life, or severe injury to occupants. The existing design codes, standards, or other documents do not contain explicit and consistent provisions and approaches to check the structural integrity of the buildings. In addition, the experimental data are insufficient and further studies are still necessary. The project aims at evaluating the structural components that can reduce the risk of collapse and developing new methodologies for assessing the structural integrity of steel frame buildings. Different structural systems and connection details were tested experimentally under static and dynamic loading conditions, and the main response parameters were quantified. Numerical models were validated against experimental data and used for an extensive numerical parametric study. The numerical simulations allowed us to improve the global response of the steel frame structures by using new or improved structural solutions and methodologies.

Project implemented by

- Coordinator (CO) – Politehnica University Timisoara
- Partner 1 (P1) - Technical University of Cluj-Napoca
- Partner 2 (P2) - URBAN-INCERC (Cluj-Napoca Branch)
- Partner 3 (P3) - INSEMEX Petrosani
- Partner 4 (P4) - SC ACI SA Cluj-Napoca



Fig. 1a. Joint specimen after the test

Implementation period

July 2012 – December 2016

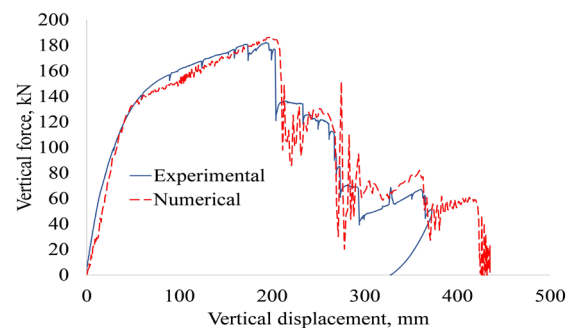

Fig. 1b. Experimental vs. numerical force-displacement curve

Main activities

- Preliminary investigations (Review of existing methods, identification of research needs; Preliminary analysis and selection of case study structures)
- Design of experimental and numerical simulation programs
- Experimental program on materials, weld details and connection macro-components
- Experimental program on joints (column loss scenarios, direct blast conditions)
- Experimental program on sub-assemblies (column loss scenarios)
- Validation of numerical models against experimental tests; Numerical simulation program



Fig. 2a. Experimental T-stub

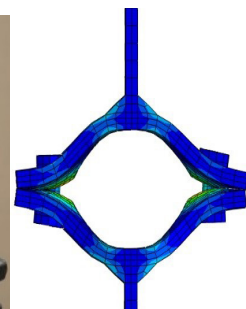

Fig. 2b. Numerical simulation T-stub

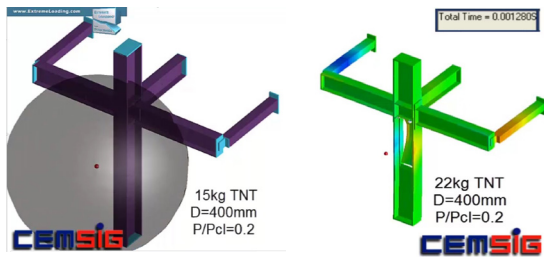

Fig. 3a (left) and 3B (right) Direct blast effect on steel assemblies

Results

- Experimental results (characteristic curves, failure modes, robustness) on T-stubs and weld detail tested in extreme conditions (loading rate, temperature)
- Experimental results on steel joints under column loss scenarios (characteristic curves, failure modes, robustness)
- Experimental results on steel and composite frame systems under column loss scenarios (characteristic curves, failure modes, robustness)
- Direct blast effects on steel elements and connections (influence of stand-off distances, charge size, charge characteristics).
- Numerical models validated against experimental tests
- Numerical simulations on different case study buildings to improve the robustness and mitigate the progressive collapse
- Recommendations for progressive collapse mitigation under column loss scenarios

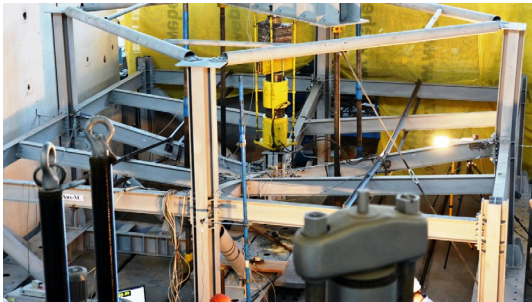

Fig. 4a. Experimental test on 3D steel frame system

Applicability and transferability of the results

- Building construction and design practice; drafting revised guidelines, codes, manuals

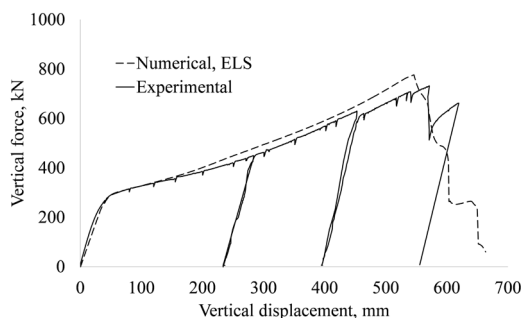

Fig. 4b. Experimental vs. numerical force displacement curve for 3D steel frame system

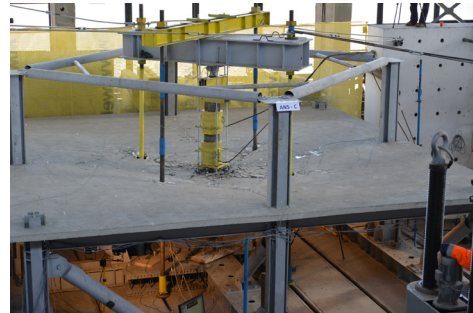

Fig. 5. Experimental test on 3D composite frame system

Financed through/by

The Executive Agency for Higher Education, Research, Development and Innovation Funding (UEFISCDI), Romania, under grant PN II PCCA 55/2012.

Research Centre

The Research Center for Mechanics of Materials and Structural Safety – CEMSIG (www.ct.upt.ro/centre/cemsig/index.htm)

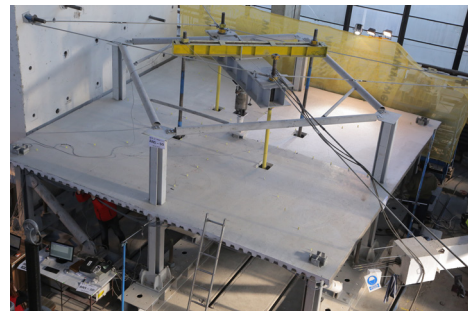

Fig. 6. Composite slab system during construction

Research Team

(UPT): Prof.dr.ing. Florea Dinu (Project Director)

Prof.dr.ing. Dan Dubina

Prof.dr.ing. Raul Zaharia

Conf.dr.ing. Adrian Ciutina

Sen.lect.dr.ing. Ioan Both

Assist.prof.dr.ing. Neagu Calin

PhD.stud.ing. Ioan Marginean

Contact information

Prof. Florea DINU

Faculty of Civil Engineering, CMMC Department, Ioan Curea 1, 300224, Timisoara

Phone: +40 256 403 912

Mobile: +40 722 460 349

E-mail: florea.dinu@upt.ro

Web: www.ct.upt.ro/centre/cemsig/codec.htm

SEISMIC PROTECTION OF ENGINEERING STRUCTURES THROUGH DISSIPATIVE BRACES OF NANO-MICRO MAGNETO-RHEOLOGICAL FLUID DAMPERS – SEMNAL-MRD

Goal of the project:

The goal of the project is to develop a seismic protection system, which uses magneto-rheological fluid (MRF) dampers, acting as semi-active structural control system. Particular objectives are:

- To develop nano-micro MRF compatible with application in seismic MR dampers;
- To design and built a 10tf capacity MR damper;
- To provide type tests, based on EN 15129-2009: Anti-seismic devices, aimed to validate, calibrate and model the damper;
- To design, execute and test a brace-damper assembly in order to validate the integration of damper and brace, including connections;
- To propose structural application schemes for implementation in practice of semi-active control brace-MRD systems.

Short description of the project:

There are three strategies for the seismic protection of structures:

- (i) reduce seismic demands,
- (ii) enhance structural damping, and
- (iii) use active or semi-active structural control.

The current project involves the third approach focusing on semi-active systems. Semi-active devices have properties that can be adjusted in real time but cannot inject energy into the controlled system. Many of them can operate on battery power alone, proving advantageous during seismic events when the main power source to the structure may fail. The most promising devices suitable for implementation into a semi-active control appear to be magneto-rheological (MR) dampers, which succeed in overcoming many of the expenses and technical difficulties associated with other types of semi-active devices.

Response characteristics of MR devices can be changed by varying the magnetic field through different current inputs. In addition to its small power requirement, the MR damper can transfer large forces at low velocities. Currently there are MR dampers with capacities up to 200 kN and research results proved the possibility to obtain capacities up to 400-500 kN.

Project implemented by

The Research Centre for Mechanics of Materials and Structural Safety – CEMSIG, Politehnica University of Timișoara.

Implementation period:

01.07.2014 – 30.09.2017

Main activities:

The activities of the project are divided in four stages (I/2014, II/2015, III/2016, IV/2017). The first three stages are completed. The fourth stage is in progress, covering several main activities:

- (i) testing of MR damper of 10tf capacity,
- (ii) testing of the brace-damper assembly,
- (iii) numerical modelling of single- and multi-degree of freedom systems.

The MR damper will be tested under different loading conditions (triangular, sinusoidal, random excitations). In addition, numerical hysteretic models will be calibrated based on the tested MR damper enabling the modeling of structural response. Since the dampers in structural systems will be coupled with braces, both single damper and brace-damper assembly tests will be performed. With a numerically simulated control unit, structural systems equipped with brace-damper assemblies will be numerically tested in order to observe and characterize their behavior.

Results:

The results of the third stage (III/2016) comprise the fabrication of the MR damper prototype, development of the testing protocol and control parameters for the MR fluid, design and fabrication of the brace-damper assembly. In the current research phase, besides the testing of the damper and brace-damper assembly, the following activities will be performed:

- (i) numerical evaluation of effectiveness of MR dampers in reducing seismic effects in structural applications;
- (ii) design and numerical testing of the control algorithm on single degree of freedom systems.

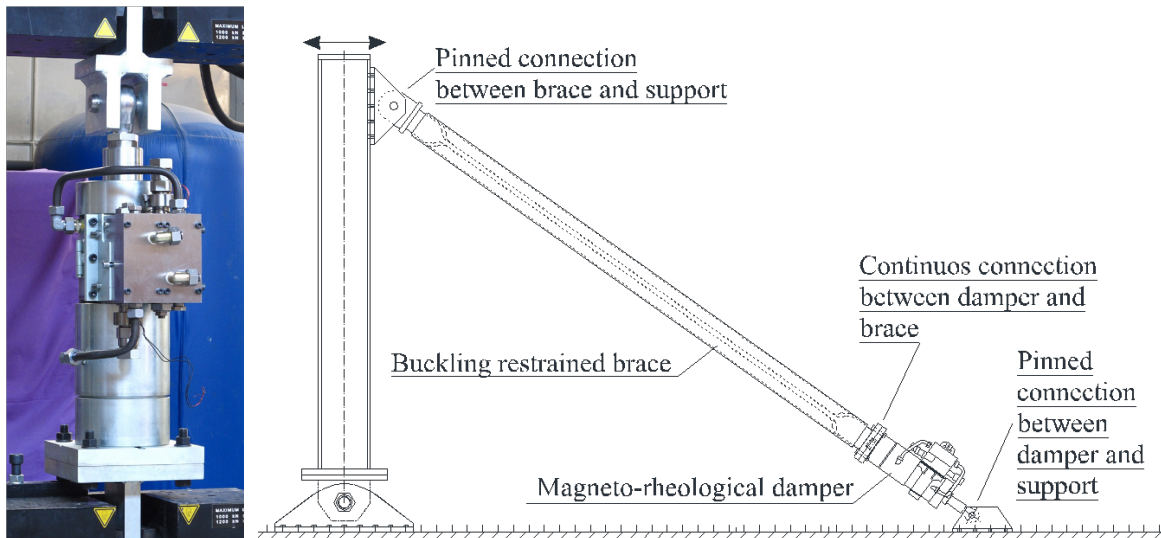

Applicability and transferability of the results:

Considering the seismicity of Romanian territory and the effectiveness of the dissipative devices targeted in the project (once under fabrication, the implementation in new and existing structures would be quite easy), the national market potential is very large. On the other hand, this market can comprise all the Balkan's area, including Turkey and Greece, with development potential towards neighboring Asian Countries.

Financed through/by

The project is supported by a grant of the Romanian National Authority for Scientific Research, CNDI–UEFISCDI, project Nr. 77 / 2014 (PN-II-PT-PCCA-2013-4-1656).

Research Center

The Research Centre for Mechanics of Materials and Structural Safety – CEMSIG, Politehnica University of Timisoara.

Research team

- UPT – Politehnica University of Timișoara (project coordinator)
- S.C. ROSEAL S.A.
- IMS-AR – Institute of Solid Mechanics of the Romanian Academy
- AR-FT – Timișoara Branch of the Romanian Academy
- S.C. TITAN S.A.

Contact information

Prof.dr.ing Dr.H.C. Dan Dubină
Member of Romanian Academy
Department of Steel Structures and Structural Mechanics,
Faculty of Civil Engineering
Politehnica University of Timișoara
e-mail: dan.dubina@upt.ro
tel: 0256 403 920

IMPLEMENTATION INTO ROMANIAN SEISMIC RESISTANT DESIGN PRACTICE OF BUCKLING RESTRAINED BRACES (IMSER)

Goal of the project:

The goal of the project is to create the background for quick implementation of the steel frames with buckling-restrained braces (BRB) into Romanian practice design.

Short description of the project:

The latest version of the Romanian seismic design provisions (P100-1/2013) have introduced, for the first time in Europe, design provisions for buckling restrained braced frames (BRBF). Buckling restrained braces have a great potential in the field of seismic design of structures due to their large ductility and symmetrical cyclic response, as compared with conventional braces.

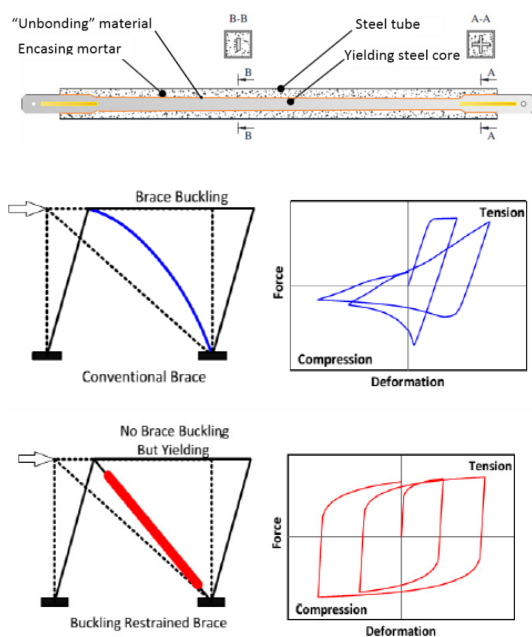

BRBF can be used both for new construction, as well as for strengthening of existing reinforced concrete, steel or masonry structures. BRB frames are able to provide two key properties of a seismic resistant structure: stiffness (for reducing interstorey drifts under moderate earthquakes) and ductility (for energy dissipation capacity under large earthquakes). BRBs were studied extensively worldwide over the past 30 years and have many practical applications especially in Japan and United States. Though researched in Europe as well, BRBs were applied in a very few applications here.

The main reasons for lack of application into practice are believed to be the absence of design provisions in EN 1998-1, not enough acquaintance with the system by practicing structural engineers, need for experimental validation, and proprietary character of most BRB devices.

Project implemented by

CEMSIG - The Research Center for Mechanics of Materials and Structural Safety - Research and Technical Development unit of Politehnica University Timisoara, at the Faculty of Civil Engineering, Department of Steel Structures and Structural Mechanics.

Implementation period:

01/07/2014 - 30/09/2017

Main activities:

- Development of two different types of BRB prototypes: "conventional" (steel core / mortar / steel casing) and "dry" (without mortar), followed by a prequalification testing program on a set of BRBs of different capacity. This will provide an initial database on prequalified BRBs, rendering project-specific experimental programs unnecessary, at least for most common design situations;
- Transfer of the "know-how" on design and production of two types of BRBs to the industrial partner, who will be able to set up quantity production of these devices;
- Development of design guidelines for buckling restrained braces (at the device level). It will allow production of generic BRBs by local producers at more competitive prices than imported ones. "Dry" (or "steel-only") BRBs are believed to be especially suited for this purpose, as they can be easily adopted by steel fabricators;
- Development of design guidelines and design examples for steel BRB frames (at system level).
- Dissemination of the project outcomes to practising engineers, through presentations in annual conferences of the Association of Structural Engineers (AICPS) and through two workshops organised in Bucharest and Timisoara.

Results:

The following results were achieved up to the present date:

1. Design of prototype structures. There were designed 16 structures (MRFs, BRBFs, D-BRBFs, and CBFs), located in Bucharest and Timisoara.
2. Selection of typical capacities of BRBs. Two typical BRB capacities were selected (300 kN, respectively 700 kN).
3. Synthesis of existing information on performance and design of BRBs was performed identifying options for component materials, technology and design methods.
4. Seismic performance evaluation of structures was performed using nonlinear static analyses for different seismic performance levels.

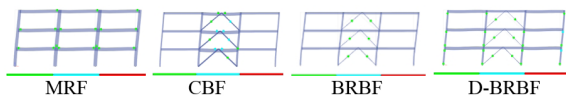

5. Development and design of BRBs. Different BRB concepts were analysed and numerically tested. A total of 14 BRBs (conventional and "dry") were designed. Code-based design and FEM analyses were performed for the parts of the experimental stand (connections, column).

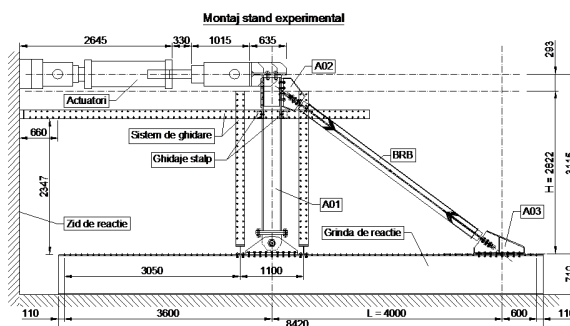
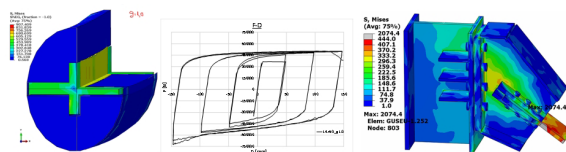

6. Manufacturing. 14 BRBs, 9 specimens for investigating the transition zone, experimental stand, and specimens for material testing were manufactured.
7. Experimental pretesting. 9 specimens were tested cyclically in order to investigate the behaviour of different BRB concepts, cutting technology.

Applicability and transferability of the results:

A Design Guide for BRBs for manufacturers, as well as a Design Guide for steel BRB frames for practising engineers will be produced within the project. Moreover, a set of BRBs will be prequalified, eliminating the need of project-specific testing. The design guidelines and the prequalification will facilitate the use of BRBs

Financed through/by

The project is supported by a grant of the Romanian National Authority for Scientific Research, CNDI–UEFISCDI, project Nr. 99 / 2014 (PN-II-PT-PCCA-2013-4-2091).

Research Center

CEMSIG - The Research Center for Mechanics of Materials and Structural Safety

Research team

- Politehnica University Timisoara, (coordinator);
- SC Popp & Asociații SRL, Bucharest;
- SC HYDOMATIC SISTEM SRL, Timisoara.



Contact information

Assoc.prof. Aurel Stratan, PhD.
 Politehnica University Timisoara
 Faculty of Civil Engineering
 Department of Steel Structures and Structural Mechanics
 Str. Ioan Curea nr. 1
 300224 Timisoara, Romania
 Phone: +40 (0) 256 403 923
 Fax: +40 (0) 256 403 917
 E-mail: aurel.stratan@upt.ro
 Web: <http://www.ct.upt.ro/centre/cemsig/imser.htm>

“SIMULTANEOUS BIOHYDROGEN PRODUCTION AND WASTEWATER TREATMENT BY SELECTIVELY ENRICHED ANAEROBIC MIXED MICROBIAL CONSORTIUM” (BIOSIM)

Goal of the project:

- Developing a selectively enriched anaerobic mixed microbial consortium able to metabolize complex, dynamic, unsterile substrates like wastewaters resulting significant amount of biohydrogen;
- Increasing the hydrogen production yield by optimizing the various physico-chemical parameters that influence the biohydrogen production process;
- Developing a novel biohydrogen production technology, in order to replace the existing methane production phase used in wastewater treatment plants.

Short description of the project:

- Developing a microbial consortium able to metabolize organic substrates with biohydrogen production

Implementation period:

01.09.2012 - 15.12.2016

Project implemented by

- CO - University of Politehnica Timisoara,
- P1 - University of Agricultural Sciences and Veterinary Medicine of Banat “King Mihai I” Timisoara,
- P2 - National Research Institute of Development in Electrochemistry and Condensed Matter Timisoara.

Main activities:

Main activities of BIOSIM proposal were:

- Establishing an anaerobic mixed consortia capable of wastewater treatment with simultaneous biohydrogen production;
- Determining the influence of different physic-chemical factors influencing wastewater treatment with simultaneous biohydrogen production and process optimization;
- Mathematical modeling of the biohydrogen production process with the development of a novel microbiological wastewater monitoring system and design of a test fuel cell system for the energy conversion of the produced biohydrogen.



Results:

Main results of BIOSIM proposal were:

1. Establishing the ideal starting inoculum capable of wastewater treatment with simultaneous biohydrogen production;
2. Design and optimization of the wastewater treatment process in order to increase the biohydrogen yield;
3. Development of a novel microbiological wastewater monitoring system and development of a logistics system model.
4. Wide-scale dissemination of the project's results, materialized through 22 articles with an impact factor to 25.

Initial glucose concentration 10%

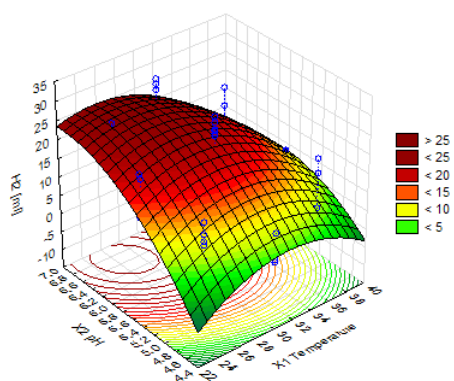

Initial glucose concentration 10%

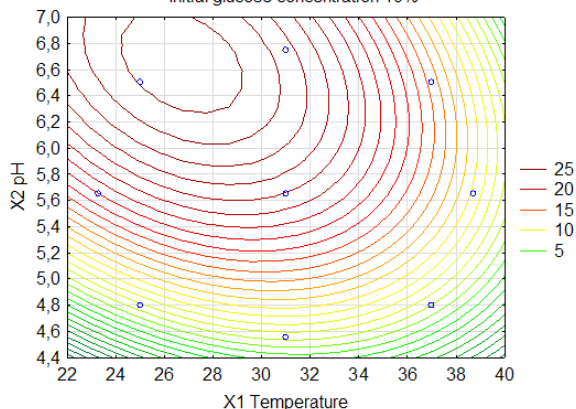

Applicability and transferability of the results:

BIO-SIM proposal combine novel high tech genomic approaches with the appropriate pretreatment of wastewaters in order to enhance hydrogen gas evolution efficiency in wastewater plants. Important efficiency increasing factor is the re-utilization effort (carbon mobilization) of the otherwise byproduct anaerobic sludge coming out from the bioconversion process.

Our technology makes possible the determination of the rate of the bacterial participants in the consortium. These information provide guidelines for the proper adjustment of the conditions in each step of biohydrogen formation process.

Financed through/by

Executive Unit for Financing Education, Research, Development and Innovation (UEFISCDI)

Research Center

ICER Politehnica Timisoara

Research team

A. CO - University of Politehnica Timisoara

1. Dr. Gergely MARÓTI – project director
2. Ş.I. Dr. Vasile GHERMAN –UPT team leader
3. Prof. Dr. Ing. Francisc PETER
4. Sl. Dr. Ing. Narcis Mihai DUŢEANU
5. S.I.Dr.Ing. Cristian-Marius STĂNILOIU-THEIS
6. Conf.Dr.Ing. Constantin FLORESCU
7. S.I.Dr.Ing. Mariana ILIE
8. Ş.I. Dr. Ing. Adina NEGREA
9. Dr. Iulian BOBOESCU
10. Dr. Gabriela GHERMAN
11. Drd. Paul MOLNAR.

B. P1 - University of Agricultural Sciences and Veterinary Medicine of Banat "King Mihai I" Timisoara:

1. Ş.I. Dr. ing. Teodor VINTILĂ – P1 team leader
2. Dr. ing. Nicolae POPA
3. Dr. ing. Daniela VINTILĂ
4. Ing. Dumitru POPESCU
5. Ec. Victoria PĂRVA
6. Ec. Cornelia CHEŢ

C. P2 - National Research Institute of Development in Electrochemistry and Condensed Matter Timisoara:

1. Dr.Fiz. Paula SFARLOAGA - P2 team leader
2. Dr.Fiz. Ioan GROZESCU
3. Dr. Ştefan NOVACONI
4. Dr.Chim. Paulina VLAZAN
5. Dr. Anamaria DABICI
6. Th. Ioan PATEANU
7. Th. Radu GURGU
8. Drd. Fiz. Daniel DAMIAN
9. Mioara ONEA

Contact information

Prof. Gergely Maroti, PhD
 Faculty of Civil Engineering /Department of Hydrotechnics
 Address: Str. George Enescu, No. 1A Postal Code 300022, Timisoara
 Phone: (+40) 256 404118
 Mobile: 0763684710
 E-mail: vasile.gherman@upt.ro

PERFORMANT POWER TRAIN FOR HYBRID AND ELECTRIC VEHICLES WITH DUAL ROTOR SINGLE STATOR AXIAL SYNCHRONOUS MACHINE AND SINGLE INVERTER - HELSAX

Goal of the project:

The project goal of bilateral cooperation between the UPT-TUIASI and UTM proposed, is of major scientific and practical importance in reducing pollution from vehicles classic using hybrid vehicles or electric drive systems performance, and aims to develop and enhance knowledge of joint research teams from Romania and Moldova, as well as enhance mobility of researchers, exchange of experience and mutual access to research infrastructure of medium and high scale, existing in the three universities.

The basic priority of the collaboration is to develop, during the implementation of the joint project, of a scientific project for participation in competitions announced by Horizon 2020 of the European Union and other international programs.

Short description of the project:

It proposes an international original solution in which the two electrical machines (generator and motor) and static converters related are replaced by a single synchronous permanent magnet machine having axial air gap, a central stator with slots on both sides and two different windings supplied from a single PWM inverter having two output frequencies, and two independent rotors.

Project implemented by

Politehnica University of Timisoara (UPT),
Technical University "Gheorghe Asachi" Iași (TUIASI) and
Technical University of Moldova (UTM)

Implementation period:

September 2016 – March 2018

Main activities:

The aim is to exploit the potential of joint research of the two teams for creating a system of electric drives for hybrid vehicles and electrical overall dimensions and low weight; reduce carbon emissions from vehicles; have a static converter that is simple and inexpensive; broadcast transmission system using differential electric vehicles; control of the two rotors so that they can operate in the same mode or in different modes at the same rotational direction or in opposite directions at the same speed value at slightly different speeds or at much different speeds. Specific objectives: increasing electrification of the vehicle; reducing vehicle weight; increasing the speed of operation of the electrical machine rotors for reducing the size of the actuator; sizing model for which the design (impose conditions of power, size, weight); design model for the electric drive system and the stand of experimental tests; increasing efficiency

for the electric drive system; the practical design of the machine, inverter and battery accumulators; exhibition experimental test setup; implementation and testing of the various experimental control solutions; creating an intelligent system for managing production and electricity consumption per vehicle. Expected results: a much easier vehicle with an electric drive system; low inertia rotor at high speeds; a compact electric drive system with high torque and simple control; an inverter that manages various operation modes with different speeds equal to or in the same direction or in opposite directions of the two rotors.

Results:

The work plan in 2016 was based on regular meetings of members of both teams alternately in Romania and Moldova. First visit was in Moldova, by a team from Romania. On this occasion the Romanian members met the team members from Moldova, visited research labs, they did contact with their scientific concerns. During this movement, a conference occurred, in order to launch the project in Chisinau, where teachers and students from the Technical University of Moldova and specialists in electrical engineering enterprises in Chisinau, Balti and Tiraspol were invited.

Then followed a visit by a team from UTM to Faculty of Electrical Engineering and Energetics in Timisoara and the Faculty of Engineering Hunedoara. On this occasion contact were established with all members of the project team from Romania, were visited research laboratories of the two faculties, and there was group discussions between members of both teams according to scientific areas of joint research. One conference was organized in order to launch the project in Timisoara, where teachers and students at the University Politehnica Timisoara and specialists of enterprises of Timisoara and Arad with automotive profile were invited. There was a travel team from Chisinau to visit industrial companies in the automotive industry in Hunedoara and Deva (Lisa Draexlmaier Hunedoara, Sews Deva).

Applicability and transferability of the results:

The motors excited by permanent magnets in a variety of designs, gaining more ground in the competition with the DC classics, because of high technical and economic achievements, especially under current conditions, in association with improved electronic supply sources and assisted computer systems that are more and more competitive. Obtaining reasonable torque values for a wide range of variation of speed, drive systems through simple procedures, are no longer a difficulty that cannot be solved. Using motors excited by permanent magnets and brushless fractional number of slots per pole and phase engines in particular, as actuators in servo-drives for low power and area, has expanded compared to the classic DC due to the progress of power electronics and information technology, without which one can not conceive an elastic system containing modern drive controllable speeds in wide range. With integrated systems for the electric drive, having adequate topologies actuators as execution elements, through the use of more evolved control algorithms and integrating functionality at both hardware and software, may lead to dynamic and superior performances, more precise control of speed or position, high electromagnetic torque, higher energy efficiency and high accuracy while simultaneously reducing overall system cost consistently. The project results will contribute to community social objectives to combat climate change. The main contribution is to reduce emissions of CO₂ and emissions of greenhouse gases. The project proposes new technologies and contributes to sustainable economic development.

Financed through/by

UEFISCDI

Research Center

UPT members of the research team are also members of the University's two research centers: the Institute for Renewable Energy and Research Centre for the intelligent control of power conversion and storage.

Research team

The research team consists of UPT coordinator conf.dr.ing. Sorin Ioan DEACONU, teachers (PhD's): Nicolae MUNTEAN, Lucian Nicolae TUTELEA, Liviu MIHON, Octavian CORNEA, Ciprian ȘORÂNDARU, Marcel TOPOR, engineers and PhD students: Loredana GHIORMEZ and Csaba GHEORGHIU.



Informbusiness Chișinău laboratory for experimental work.



Helsax project launch conference in Chisinau.



Helsax project launch conference in Hunedoara.

Contact information

Associate Prof. Sorin Ioan DEACONU, PhD
Faculty/Department Address: Revolutiei Str., No. 5,
Postal Code 331128, Hunedoara
Phone: (+40) 254 207529
Mobile: (+40) 744 544846
E-mail: sorin.deaconu@fih.upt.ro
Web: www.fih.upt.ro

EXPLORATION SYSTEM FOR OPTIMIZATION OF SHAPE MEMORY ACTUATION IN COMPOSITIONAL SPREADS

Goal of the project

The project had as main fundamental objectives the development of an exploration system that would allow:

- a combinatorial optimization of actuation using the sputtering technique to generate compositional spreads;
- the development of models for combinatorial systems adapted for investigation of actuation;
- the implementation of the combinatorial exploration system for the case of intelligent materials, with focus on shape memory alloy families;
- the development of microactuators with controlled and optimized functionality;
- the investigation or modelling of systems for the exploration, and
- the microfabrication of materials with "on demand" properties, adapted for applications in microsystem engineering.

Short description of the project

The project aims to design, fabricate and develop a combinatorial exploration system for optimization of microactuation using the sputtering technique of thin film compositional spreads.

Project implemented by

Politehnica University Timisoara, Romania

Implementation period

03.10.2011 - 02.10.2017

Main activities

The experimental objectives of the project were:

- identification of specific design requirements for a system dedicated to generating combinatorial libraries of metallic materials;
- design of an exploration path for specific functionalities;
- design and fabrication of an exploratory system that allows sputtering of compositional spreads;
- design and microfabrication of substrates for the investigations of functional libraries;
- microfabrication of sputtered compositional spreads based on shape memory alloy compositions;
- microstructural-compositional characterization of libraries;
- design of an actuator based on thin film microfabrication.

Results

Actuation prediction in bimorphs based on shape memory alloy films

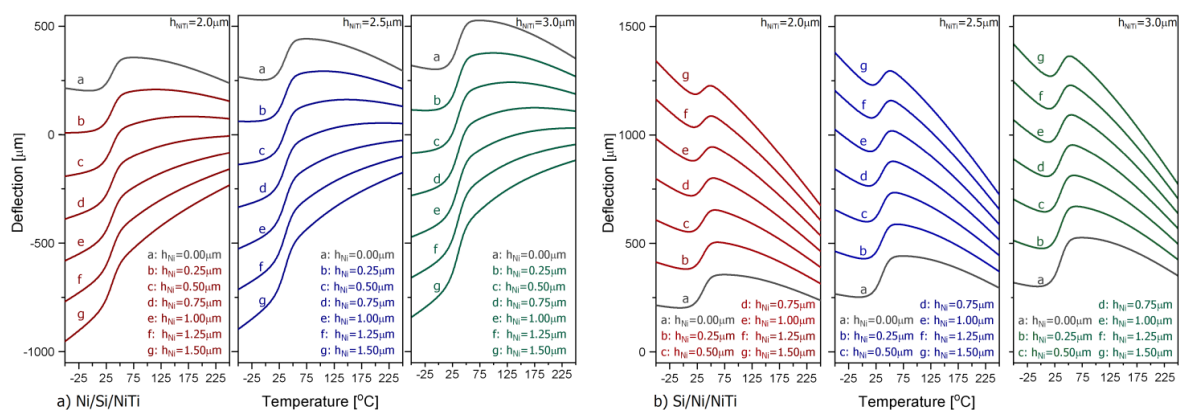

Acquisition of an electron microscope and development of a 3 axis measurement system for electric resistance and deflection as a function of temperature

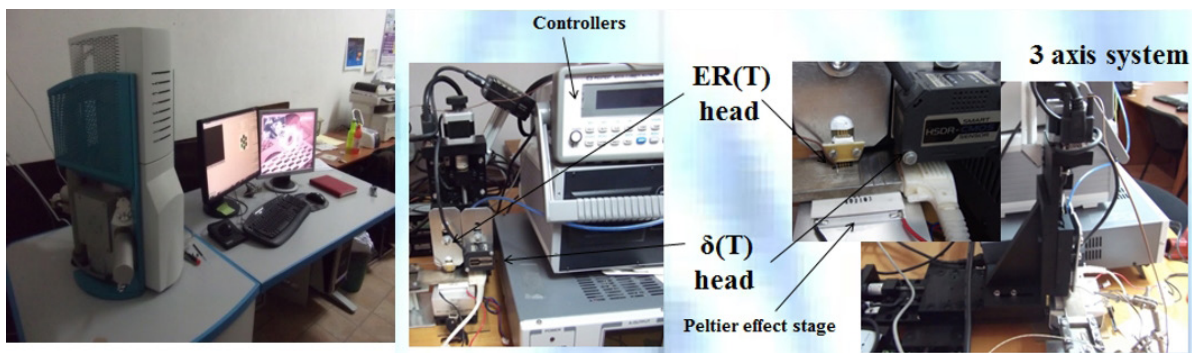

Design and fabrication of an equipment for combinatorial exploration

Fabrication and characterization of shape memory alloy libraries

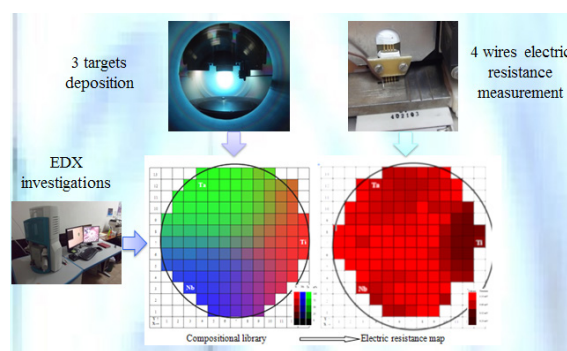

Dissemination:

- 15 ISI Papers with impact factor
- 6 ISI Proceedings papers
- 3 published books

Applicability and transferability of the results

In the field of micro and nanoengineering and in the research of new materials

Financed through/by

Romanian National Authority for Scientific Research CNCS – UEFISCDI

Research centre

Center for Smart Materials Micro and nanoengineering

Research team

- Prof. Corneliu M. Craciunescu
- Prof. Ion Mitelea
- Prof. Victor Budau
- Assoc. Prof. Aurel Ercuta
- Ing. Roxana Sprancenatu

Contact information

Prof. Corneliu Marius CRACIUNESCU, PhD, Ing. Habil.
 Faculty of Mechanical Engineering /Department of Materials and manufacturing Engineering; Address: Bd. Mihai Viteazul, No. 1, 300022, Timișoara
 Phone: (+40) 256 403655
 Mobile: not supplied by university, therefore not public
 E-mail: corneliu.craciunescu@upt.ro
 Web: http://www.upt.ro/img/files/2016-2017/cercetare/ppr/ESOP_2011-2016.pdf

IMPROVEMENT OF THE TITANIUM WEAR RESISTANCE BY ELECTRON BEAM REMELTING OF THE PRE-DEPOSITED THERMAL SPRAYED COATINGS

Goal of the project

Improvement of the exploitation performance of the titanium, especially wear behavior, without influencing its good corrosion resistance

Short description of the project

Titanium is one of the most promising metals in field of high specific strength engineering. Although it offers attractive mechanical, chemical and physical properties, its surface properties are deficient, possessing poor fretting fatigue resistance and poor wear resistance properties. Thermal spray coatings is one of the most common ways to improve the surface characteristics of the materials being used in a wide range of industries to improve the abrasive, erosive, and sliding wear of machine components.

The proposed theme focuses on the improving of the titanium wear resistance by electron beam (EB) remelting of the pre-deposited oxidic powder $Al_2O_3-TiO_2$ using the high velocity oxygen fuel (HVOF) and atmospheric plasma spraying (APS) methods. The EB treatment may lead to the elimination of porosity, enhancement of the coating strength and chemical homogeneity, and the development of metallurgical bonding at the coating-substrate interface producing strengthened coatings adhesion.

Project implemented by

University Politehnica Timisoara

Implementation period

02.09.2013 - 12.12.2016

Main activities

- State of the art and perspectives evaluation in surface coatings technique used as a method in order to improve the wear behavior of the titanium;
- Development of HVOF and APS sprayed $Al_2O_3-TiO_2$ coatings on the surface of titanium and their remelting using the electron beam (EB) method;
- Analysis and characterization of the obtained HVOF and APS sprayed $Al_2O_3-TiO_2$ coatings before and after the electron beam remelting treatment;
- Study of the wear and corrosion behavior of the coatings before and after the electron beam remelting;

Results

For the final stage of the project it has been obtained the following results:

- Study of the wear and corrosion behavior of the coatings before and after the electron beam remelting;

The results of this project demonstrated that the deposition and EB-remelting of $Al_2O_3-TiO_2$ coatings onto the titanium surface is a solution for the improvement of sliding wear resistance of this material without a major decrease in corrosion resistance. Moreover, the electron beam treatment can be used for fabrication of compact and homogenous coatings with higher adherence to the substrate.

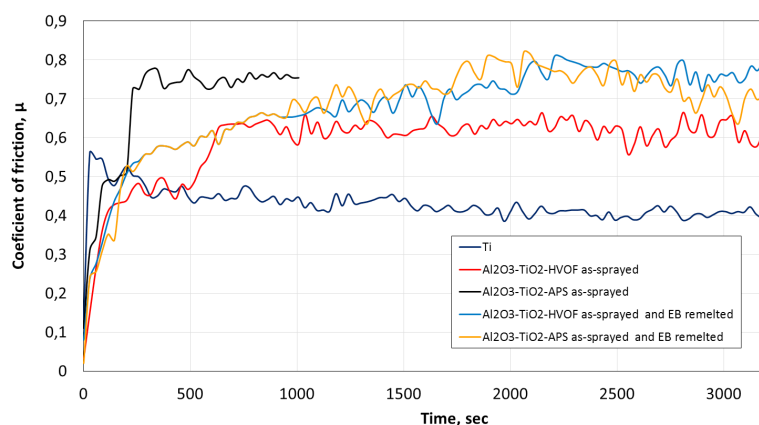

Evolution of the friction coefficient in time for the tested materials

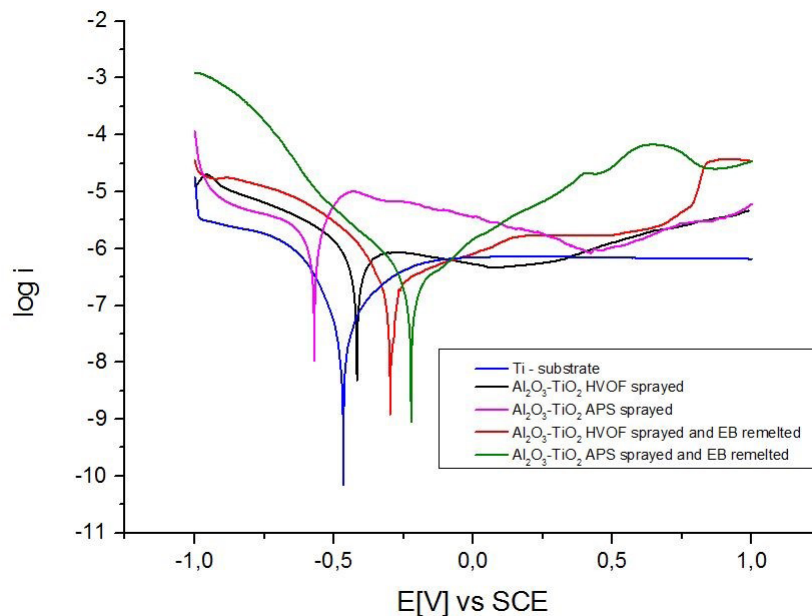

Potentiodynamic polarization curves of the samples tested in 3.5 % NaCl solution

Applicability and transferability of the results

The results which will be obtained in frame of the project will be transferred to companies in the field of automotive industry and not only. Also they will be presented to national and international conferences and published in scientific journals.

Financed through/by

EXECUTIVE UNIT FOR FINANCING EDUCATION HIGHER RESEARCH DEVELOPMENT AND INNOVATION (UEFISCDI)

Research Centre

Research Centre for Processing and Characterization of Advanced Materials

Research team

Project manager: Ion-Dragoş UTU

Team members:

Viorel-Aurel SERBAN – senior researcher

Cosmin CODREAN – senior researcher

Carmen OPRIS – senior researcher

Iosif HULKA – postdoc researcher

Contact information

Assoc. Prof. Dr.Ing. Ion-Dragoş UTU

Materials and Manufacturing Engineering Department, Faculty of Mechanical Engineering

Address: Bd. Mihai Viteazu, No. 1, RO300222, Timisoara

Phone: (+40) 256 403 656

E-mail: dragos.utu@upt.ro

Web: www.upt.ro/Informatii_UPT_504_ro.html

INNOVATIVE, ECOLOGIC AND EFFICIENT TECHNOLOGIES FOR JOINING METALLIC AND POLYMERIC MATERIALS USED IN AUTOMOTIVE INDUSTRY BY FRICTION STIR WELDING (INOVA-FSW)

Goal of the project

The project is focused on studying the possibilities of using Friction Stir Welding (FSW) for joining dissimilar material (metallic and polymeric) for automotive industry. Solid state welding process, like FSW, avoid the precipitation of secondary phases in the welded joint, resulting a high quality welded joint, even between materials impossible/difficult to weld with fusion welding processes. The main goal of the project is to obtain welding technologies for joining Al-Cu, Al-Steel, as well as different polymeric materials.

Short description of the project

The project studies the possibility to join, by FSW, Al-Cu, Al-steel and different types of polymeric materials.

Project implemented by

The partners in this project are: University Politehnica Timisoara (UPT), National R&D Institute for Welding and Material Testing – ISIM, Timisoara, University of Pitesti and Renault Technologie Roumanie (part of the Renault Group). The last partner will also implement the results of the project.

Implementation period

14.07.2014 – 30.09.2017

Main activities

The main activities of the project:

- defining the materials for the welding tools, technological parameters, testing procedures and quality specifications;
- experimental studies for joining Al (and aluminum alloys) with Cu (and copper alloys) and different polymeric materials;
- experimental studies for joining Al (and aluminum alloys) with steel;
- numerical modeling of FSW welding of dissimilar materials;
- testing of welded joints, optimization of the welding procedures (building a data base with results);
- dissemination of the results.

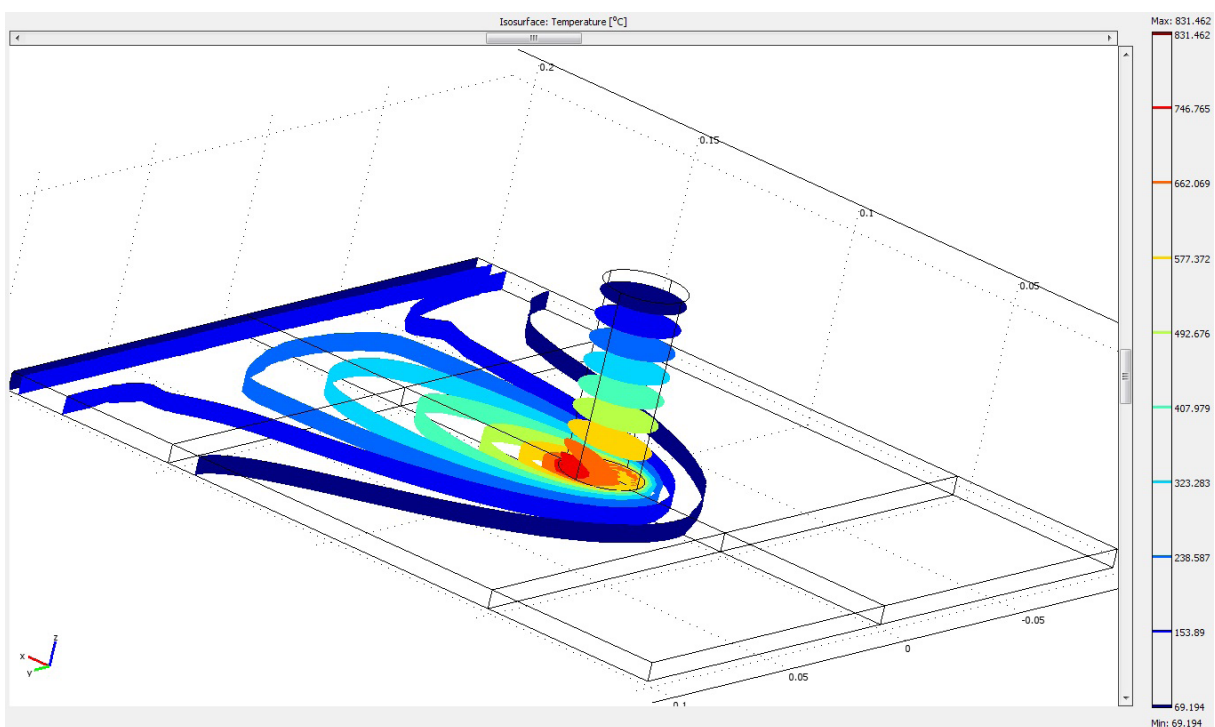

Results

The project results are materialized in more than 10 FSW technologies (tested and certified), for joining aluminum alloys with copper alloys, aluminum alloys with steel and also different polymeric materials. Also, there were 6 scientific papers that were published, based on the results of this project.

Applicability and transferability of the results

The result of the project will be transferred and applied mainly at the partner Renault Technologie Roumanie (part of the Renault Group), but they are available to all industrial entities working mainly in automotive industry.

Financed through/by

UEFISCDI in grant PN-II-PT-PCCA-2013-4-1858 (Inova-FSW, contract 219/2014).

Research Centre

ICER – Institutul de Cercetari pentru Energii Regenerabile

Research team

University Politehnica Timisoara (UPT);
National R&D Institute for Welding and Material Testing
– ISIM, Timisoara;
University of Pitesti
Renault Technologie Roumanie (part of the Renault Group).

Contact information

conf. Bogdan RADU, PhD
Department Materials Engineering and Fabrication,
b-dul Mihai Viteazul nr. 1, 300222, Timisoara
Phone: (+40) 256 403647
Mobile: +40746190268
E-mail: bogdan.radu@upt.ro
Web: <http://www.inovafsw.upt.ro/>

KNOWLEDGE MANAGEMENT-BASED RESEARCH CONCERNING INDUSTRY-UNIVERSITY COLLABORATION IN AN OPEN INNOVATION CONTEXT (UNIINOI)

Goal of the project

In the present competitive climate, knowledge and innovation are seen as the main distinguish factors of the organizations' success and as the basis of their competitive advantages. Following a long tradition of research in the field of innovation, open innovation is an approach in which the boundaries of innovation are shifting from a situation where organizations conduct research and development activities mainly internally, to a widespread collaboration and external knowledge source, in order to support achieving and sustaining continuous innovation of their product, services or processes. Furthermore, universities are seen among the most important partners with whom business organizations can cooperate for quantitative empirical evidence concerning the development, evolution and sustainability of Industry-University relations in Open Innovation. Despite the intensive efforts from both sides for the development of bilateral collaborations in the research and innovation field there are still space and resources for increasing the knowledge processed between these actors.

Short description of the project

The project activities are focuses on designing a feasible strategy (based on a model and an associated methodology) for the UNlinOI together with the definition of a set or a system of key performance criteria in order to characterize this process. The validation of the whole proposed approach for the increasing of the UNlinOI is developed in the case of Romanian universities and industrial organizations. All partners in the project will support the design and validation process of the model and methodology designed solutions..

Project implemented by

Project coordinator - University of Oradea www.uoradea.ro
Partener 1 - Politehnica University of Timisoara www.upt.ro
Partener 2 - Technical University of Cluj-Napoca www.utcluj.ro
Partener 3- S.C. EMSIL TECHTRANS S.R.L. Oradea, Romania

Implementation period

2014-2017

Main activities

Stage I - The development of the collaborative research environment (2014)
Stage II - The development of an Open Innovation environment between Industry-University (2015)
Stage III - The development of a model for the performance measurement of Industry-University collaboration in Open Innovation (2016)
Stage IV - The development of a methodology (associated with the previous designed model) for the performance measurement of Industry-University collaboration in Open Innovation (2017)

Results

During the project implementation there have been developed the ontology of UNlinOI (Fig. 1) using an appropriate software application for the knowledge map design and visualization. The ontology representation has a tree structure that include the description of each considered item as: motivation factors, barriers, channels for the knowledge transfer, benefits and disadvantages (dimensions of the proposed ontology considered as sub-ontologies). The ontology of UNlinOI allows the analysis and optimization of the different knowledge transfer processes, activities or interdependences by considering different items depicted in each sub-ontology. Therefore, each item has been detailed, for its complete characterization using relevant, actual references and existing regulations, norms for research and development activities in Romania.

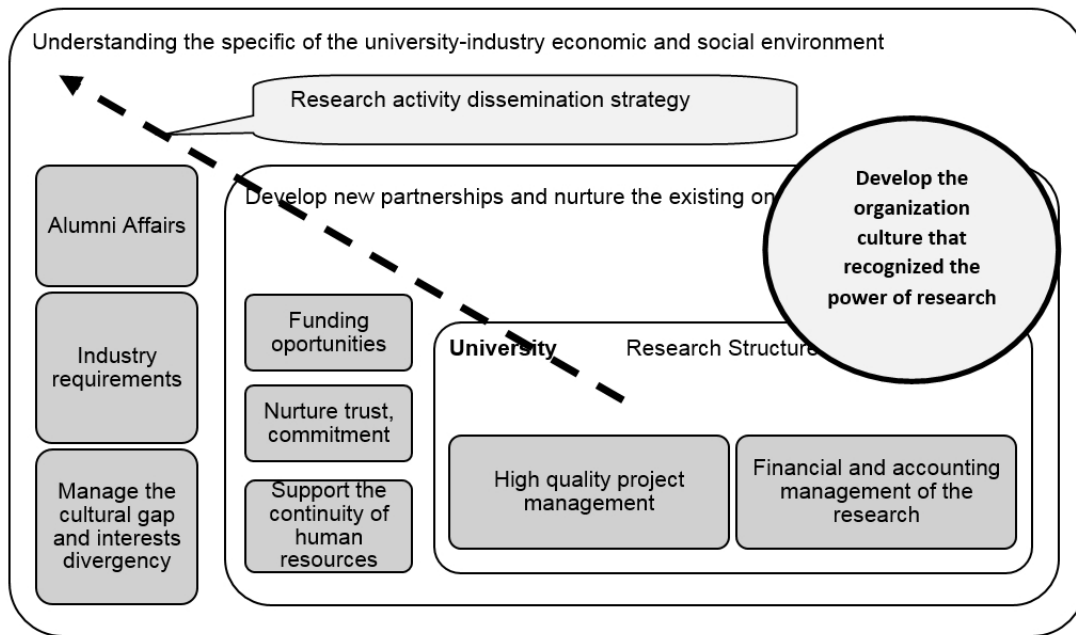

The proposed model (or framework) for the UNlinOI

Applicability and transferability of the results

1. The projects' research results could be transferred in universities practices in order to define the strategy with its industrial partners in the local and regional areas (derived from a business model). In addition, the results could be useful for the internal procedures development and for the definition of a scientific framework in order to strength and intensify UNlinOI (including the development of future joint projects);
2. The research results could be easy transfer to industrial entities in order to foster UNlinOI;
3. Project's research results were transferred in the didactical process (master level) and enriched the knowledge bases of our didactical and PhD students' projects.

Financed through/by

The project is supported by the Ministry of National Education through The Executive Unit for Financing Higher Education, Research, Development and Innovation in the context of Partnerships in Priority Domains Programme.

Research Centre

Engineering and Management Research Center

Research team

Prof. Anca DRAGHICI (project responsible)
 Prof. George DRAGHICI
 As. PhD. Larisa-Victoria IVASCU

Contact information

Prof. Anca DRAGHICI, PhD
 Faculty of Management in Production and Transportation
 Department of Management
 Address: Remus Str., No. 14, 300191, Timisoara
 Phone: (+40) 256 403 610
 E-mail: anca.draghici@upt.ro
 Web: www.mpt.upt.ro

THE IMPACT OF THE ECONOMIC AND FINANCIAL STABILITY ON INVESTMENTS, INNOVATION PROCESS AND ENTREPRENEURIAL ACTIVITY IN THE EU

Goal of the project

The aim of the project is to analyze the relationship between economic and financial stability on the one hand, and investment, innovation and entrepreneurship on the other hand, with a focus on the EU countries.

Short description of the projects

The economic and financial stability plays an important role in promoting investment, in influencing the entrepreneurs' decisions and in enhancing the national innovativeness capacity. These aspects, extremely important for the European strategy for economic recovery and job creation are not sufficiently explored in the literature, while their empirical investigation is practically inexistent.

Project implemented by

Politehnica University of Timisoara, Management Department

Implementation period

01.10.2015 – 30.09.2017

Main activities

1. We develop the research on three directions:

- we analyze the link between stability and investments, considering the sectorial particularities of the investments' determinants, using FDI and firm-level data.
- we investigate the role of the stability in enhancing the national innovativeness capacity.
- we explore the relationship between the economic stability and the entrepreneurial activity, to see which are the economic sectors where the entrepreneurial decision is sensitive to the evolution of the macroeconomic fundamentals.

2. Manipulation of AMADEUS statistics for firms' financial statements

3. Econometric analyses and generation of results

4. Dissemination of results

Results

Journal articles:

- Albulescu, C.T. and Ianc, N.B. (2016), Fiscal policy, FDI and macroeconomic stabilization, *Review of Economic and Business Studies*, 9(2), 131-146.
- Albulescu, C.T. and Draghici, A. (2016). Entrepreneurial activity and national innovative capacity in selected European countries, *The International Journal of Entrepreneurship and Innovation*, 17(3), 155-172.
- Albulescu, C.T., Tamasila, M. and Taucean, I.M. (2016). Shadow economy, tax policies, institutional weakness and financial stability in selected OECD countries. *Economics Bulletin*, 36(3), 1868-1875.

Conference papers:

- Albulescu, C.T., Miclea, S., Tamasila, M. and Taucean, I.M. (2016), The working capital and liquidity's role in explaining the Italians' firms profitability around the recent financial crisis. *Proceedings of the 5th Review of Management and Economic Engineering International Management Conference*, pp. 129-139.
- Draghici, A., Siakas, K., Albulescu, C.T. (2016), Comparison between entrepreneurship education in Romania and Greece - the case of two higher education institutions, *ERiE 2016 conference*, june 2016, Prague, Czech Republic, pp. 87-98.
- Albulescu, C.T. and Miclea, S. (2016), The interdependence between Italian firms' access to finance and their probability of default, *Proceedings of the MakeLearn and TIIM Joint International Conference*, 25-27 May 2016 Timisoara, Romania, pp. 697-703. (Best Paper Award)
- Albulescu, C.T., Breznik, K. and Dermol, V. (2016), What we understand by financial stability: text analysis with network approach, *Proceedings of the MakeLearn and TIIM Joint International Conference*, 25-27 May 2016 Timisoara, Romania, pp. 943-951.
- Albulescu, C.T., Tamasila, M. and Taucean, I.M. (2016). Entrepreneurship, tax evasion and corruption in Europe, *Procedia - Social and Behavioral Sciences*, 221, pp. 246-253.

Research stages:

- Claudiu Albulescu, University of Poitiers
- Bogdan Ianc, University of Orléans
- Adrian Ionescu, University of Orléans

Applicability and transferability of the results

The findings have practical implications for investment and financial managers of companies operating in different economic fields. The results have also practical implication for authorities, helping them to identify the elements which enhance the investment and the entrepreneurial activity, in order to sustain the economic growth and job creation. Further, relying on a sectorial analysis, the findings give a complete understanding about the determinants of investment and entrepreneurship, specific to each industry.

Financed through/by

Executive Unit for Financing Higher Education, Research, Development and Innovation - UEFISCDI

Research Centre

Engineering and Management Research Centre

Research Team

Assoc. Prof. Claudiu Albulescu, PhD
Assoc. Prof. Matei Tămășilă, PhD
Lect. Ilie Mihai Tăucean, PhD
Assist. Prof. Șerban Miclea, PhD
PhD student Bogdan Ianc
PhD student Adrian Ionescu
PhD student Simina Suciu

Contact information

Assoc.Prof. Claudiu ALBULESCU, PhD
Faculty of Management in Production and Transportation,
Management Department, Remus Street, no. 14, 300191, Timișoara
Phone: (+40) 256 404 035
Mobile: (+40) 743 089 759
E-mail: claudiu.albulescu@upt.ro
Web: <https://sites.google.com/site/isiaue/>

RANDOM MATRIX TECHNIQUES IN QUANTUM INFORMATION THEORY (RMTQIT)

Goal of the project

The field of Quantum Information Theory (QIT) attracted lately the interest of scientific community due to its ambitious goals meant to create new technologic systems (quantum computers) and more secured methods to transmit the information. Nowadays, QIT is a multi-faceted field, with large connections in the subfields of Mathematics, such as Functional Analysis, Operator Theory, Linear Algebra, Probability Theory. The project RMTQIT purposes to give answers to open questions from QIT, using techniques from random matrix theory.

Short description of the project

The project RMTQIT focuses on a systematic exploration of theoretical questions in QIT about random quantum states and random quantum channels. These problems have attracted the attention lately in a very naturally connection to fundamental issues of QIT theory, such as entanglement theory and classical (or quantum) capacities for channels.

Project implemented by

- The Department of Mathematics, University Politehnica Timișoara, Romania
- Laboratoire de Physique Théorique de Toulouse, Université Paul Sabatier Toulouse III, France

Implementation period

1st March 2013–31st August 2016



Main activities

The activities developed within the project RMTQIT in 2016 mainly focused on completing the tasks proposed initially as well as to formulate new issues. It is relevant to mention that the team of the project submitted a joint paper with new results related to the decomposition of an arbitrary operator as a symmetric sum of positive semidefinite operators, focusing mostly on questions about the possible values of the symmetry parameters. The questions we asked are of interest from purely mathematical point of view as well as for its applications in the theory of SIC-POVMs or equiangular tight frames. Our results hold in the most general setting existing for decompositions of positive operators and prove to be useful also for classical set up; for example, for POVM case, we show that extremal decompositions for qubits exist iff the operator (the sum of the decomposition) is scalar. These results have been presented (by M.A. Jivulescu) with several occasions at international conferences and workshops, such as

1. Decomposition of positive operators with applications in Quantum Information Theory, School on Stochastic Methods in Quantum Mechanics, Autran, Franța, July 2016
2. On some decomposition of positive semidefinite operators by symmetric families of operators, Theodor Angheluta Seminar, The 15th International Conference on Applied Mathematics and Computer Science, Cluj-Napoca, July 5–7, 2016
3. Some decomposition of positive semidefinite operators, 26th Conference on Operator Theory, Timisoara, June 2016
4. Sisteme dinamice in teoria informatiei cuantice, Conferința Diaspora, Cercetarea Științifică și Invățământul Superior din Romania - Diaspora și prietenii săi, Timisoara, 25–28 April 2016

Results

The main results of the project RMTQIT were resumed in the papers listed below

1. Maria Anastasia Jivulescu, Ion Nechita, Pasc Gavruta-On symmetric decompositions of positive operators-arXiv:1609.05060
2. Maria Anastasia Jivulescu, Nicolae Lupa, Ion Nechita - Thresholds for reduction-related entanglement criteria in quantum information theory- Quantum Information and Computation, vol 15, no 13&14 (2015), pp 1165–1184 (arXiv: 1503.08008)
3. Maria Anastasia Jivulescu, Nicolae Lupa, Ion Nechita, David Reeb - Positive reduction from spectra - Linear Algebra and its Applications 469 (2015) 276–304 (<http://arxiv.org/abs/1406.1277> arXiv:1406.1277)

Financed through/by

- Executive Agency for Higher Education, Research, Development and Innovation Funding (UEFISCDI)
- L'Agence Nationale de la Recherche (ANR), France

Research Team

Assist. Prof. Maria Anastasia Jivulescu

Dr. Ion Nechita

Prof. Găvruta Paşc

Assist. Dr. Nicolae Lupa

Contact information

Assist. Prof. Maria Anastasia JIVULESCU

Department of Mathematics

Address: Victoriei Square, no 2, RO300006, Timișoara

Phone: (+40) 256 403 098

Fax.: (+40) 256 403 109

Mobile: (+40) 740 517 340

E-mail: maria.jivulescu@upt.ro

Web:<https://sites.google.com/site/rmtqit2013/>

HIGH MAGNETIZATION MAGNETIC NANOFUIDS AND NANO-MICRO COMPOSITE MAGNETIZABLE FLUIDS: APPLICATIONS IN HEAVY DUTY ROTATING SEALS AND MAGNETORHEOLOGICAL DEVICES

Goal of the project

The project is oriented to the extension of performances of rotating seals and adaptive motion control devices to meet the requirements of several well-defined new applications, by high and very high magnetization sealing fluids and new type of magnetorheological fluids to be synthesized.

Short description of the project

The project concept and objectives are illustrated schematically in figure below.

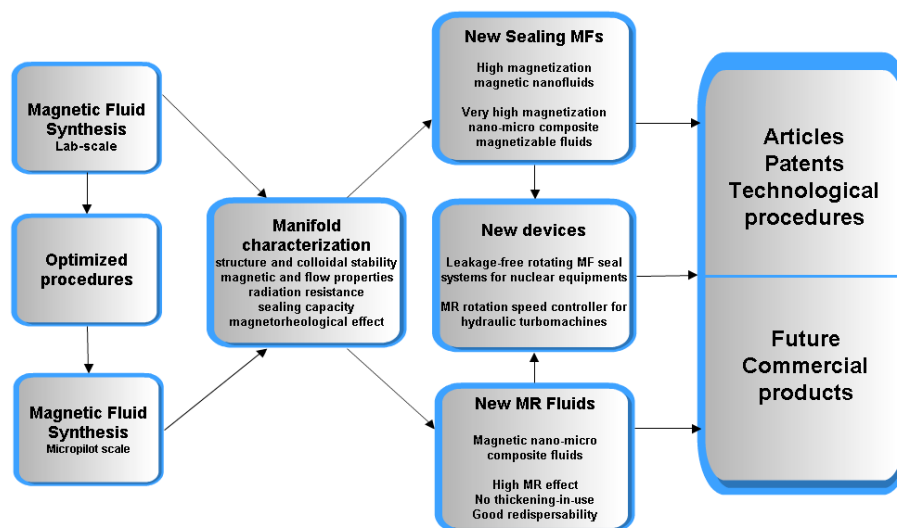

The workflow is organized along the following main directions: lab-scale and micro-pilot scale synthesis of high magnetization and radiation resistant magnetic nanofluids and nano-micro composite fluids for heavy duty (high pressure and /or rotation speed, contaminated medium) rotating seal and semi-active magnetorheological motion control applications; advanced structural, magnetic, rheological, magnetorheological characterization of the new magnetizable fluids; accelerated (irradiation) ageing and sealing capacity tests; design, manufacturing and experimental testing of leakage-free rotating seals for nuclear equipments and magnetorheological rotation speed controller devices for hydraulic turbomachines. The new rotating seal and motion control systems for nuclear and hydraulic equipments offer better quality than usual solutions have, will help to gain new market shares and open technological advantages over traditional manufacturing routes. The seal systems proposed for nuclear equipments offer much higher level of environmental protection over traditional sealing units due to the leakage-free property of magnetic fluid rotating seals, increasing the commercial value of the solutions proposed.

Project implemented by

- Romanian Academy – Timisoara Branch (Project coordinator),
- Politehnica University of Timisoara (Partner 1),
- S.C. ROSEAL S.A. Odorheiu Secuiesc (Partner 2)
- National Institute for R&D in Electrical Engineering ICPE-CA Bucuresti (Partner 3).

Implementation period

July 23, 2012 – December 31, 2016

Main activities

Main activities of the MagNanoMicroSeal project are: (01) Synthesis and manifold characterization of magnetizable fluids for high pressure and heavy duty rotating seals and magnetorheological devices and, respectively, (02) Design, fabrication and testing of leakage-free magnetofluidic rotating seal and magnetorheological(MR) control devices for well-defined applications/exploitation conditions.

Results

The main results of this project, to which Politehnica University of Timisoara contributed, refer to the elaboration of the following technological procedures:

- synthesis of high magnetization sealing fluids;
- synthesis of nano-micro structured magnetorheological fluids and qualification procedures;
- magnetic nanofluids for rotating seals for nuclear equipments.

The contributions of Politehnica University of Timisoara refer mainly to complex magnetic, rheological and magneto-rheological analyses of the magnetic sealing fluids and nano-micro structured magnetorheological fluids. The Politehnica University team oversaw the characterization of the magnetic nanofluids to be used for seals.

The results obtained in 2016 by the UPT team were disseminated in: Oana Marinica, Daniela Susan-Resiga, Florica Balanean, Daniel Vizman, Vlad Socoliuc, Ladislau Vekas, Nano-micro composite magnetic fluids: magnetic and magnetorheological evaluation for rotating seal and vibration damper applications, *Journal of Magnetism and Magnetic Materials*, 406, 134-143 (2016), FI=2.357 (2015/2016).

Applicability and transferability of the results

The technological progress is strongly evidenced by future commercial products planned for the industrial partner SC ROSEAL SA: 16 new type of magnetically controllable fluids, 1 prototype and 3 functional models of magnetofluidic devices for nuclear and hydraulic power engineering.

Financed through/by

the Ministry of Education, Research, Youth and Sports (MECTS) – Executive Unit for Financing Higher Education, Research, Development and Innovation (UEFISCDI) through the PN II Program Partnerships in Priority Areas, Collaborative applied research projects, PCCA 2011.

Research centre

Research Centre for Engineering of Systems with Complex Fluids – Magnetometry Laboratory, Rheology Laboratory and Numerical Simulation and Parallel Computing Laboratory, from Politehnica University of Timisoara. URL: <http://mh.mec.upt.ro/ccisfc/>

Research team

The project research team consists of 42 researchers, engineers and technicians lead by

Dr. Ladislau VÉKÁS, the director of the MagNanoMicroSeal project (Romanian Academy Timisoara Branch).

The Politehnica University of Timisoara (Partner 1) research team in this project consist of 6 researchers and 2 research assistants, as follows:

Assoc. Prof. Dr.-Eng. Floriana D. STOIAN, project responsible for partner 1,
Phys. Oana Marinică,
Lect. Dr.-Eng. Mat. Sorin Holotescu,
Assoc. Prof. Dr.-Eng. Nicolae Crainic,
Lect. Dr.-Eng. Andreea Dobra,
Lect. Dr.-Eng. Adelina Han,
Res. Assist. Florica Bălănean,
Res. Assist. George Giula.

Contact information

Dr. Ladislau VÉKÁS, Corresponding Member of the Romanian Academy, Project coordinator
Romanian Academy Timisoara Branch
24 Mihai Viteazu Bv., 300223 Timisoara
Tel.: +40-256-403700; +40-256-403703;
E-mail: vekas@acad-tim.tm.edu.ro; vekas.ladislau@gmail.com

Assoc. Prof. Floriana D. STOIAN, PhD
Faculty of Mechanical Engineering/ Department of Mechanical Machines, Technology and Transportation,
UPT Partner responsible
1 Mihai Viteazu Bv., 300222 Timișoara
Tel.: +40-256-403671; +40-256-403700;
Mobile: +40-744-597308
E-mail: floriana.stoian@upt.ro; fdstoian@yahoo.com

ENVIRONMENTAL ENERGY HARVESTING HYBRID SYSTEM BY PHOTOVOLTAIC AND PIEZOELECTRIC CONVERSION, DC/DC TRANSFORMATION WITH MEMS INTEGRATION AND ADAPTIVE STORAGE

Goal of the project

The design, building and testing of the prototype of a hybrid system for energy harvesting from the ambient through photovoltaic conversion, DC/DC transformation with MEMS integration and adaptive storage, will be carried out. First key novel component of the device is the planar power micro-transformer for high frequency, with hybrid magnetic nanofluid/ferrite core and windings- a part of the DC/DC converter, fabricated in MEMS technology. A second key component is the photovoltaic cell, which relies on novel solutions.

Short description of the project

A prototype with wireless sensors powered by the harvesting system will be designed, built and tested. In this endeavor, there will be prepared a dedicated magnetic fluid to be used as core of a micro-transformer, which will be designed accordingly and tested. Further, an experimental model of the energy harvesting hybrid system will be elaborated, designed and tested. Finally, a prototype for the harvesting device will be designed and tested.

Project implemented by

- National Institute for R&D in Electrical Engineering ICPE-CA Bucharest (Coordinator)
- Politehnica University of Timisoara (Partner 1)
- Romanian Academy – Timisoara Branch (Partner 2)
- Politehnica University of Bucharest (Partner 3)
- SYSCOM PROCESS CONTROL LTD (Partner 4).

Implementation period

July 1st, 2014 – September 30, 2017

Main activities

The main activities are as follows:

- (I) elaboration of the experimental model of the energy harvesting hybrid system by photovoltaic conversion and DC/DC transformation with MEMS integration;
- (II) design and testing of the experimental model of the energy harvesting hybrid system by photovoltaic conversion and DC/DC transformation with MEMS integration;
- (III) design and testing of the prototype of the energy harvesting hybrid system by photovoltaic conversion and DC/DC transformation with MEMS integration.

The 2016 year research aimed to complete the second activity listed above. Politehnica University team (P1), together with the Romanian Academy – Timisoara Branch team (P2), is responsible for the preparation and characterization (in terms of magnetic, rheological, electrical, thermal and structural properties) of the magnetic fluid used as magnetic fluid core of the power micro-transformer.

Results

The main result of the project will be the integration of an innovative photovoltaic conversion system and an original DC/DC converter, which utilizes a planar, spiral, MEMS, hybrid (magnetic nanofluid/ferrite) cored micro-transformer in an efficient device for energy harvesting. Regarding the use of a magnetic nanofluid core micro-transformer for the DC/DC converter, from the manufacturing point of view, it is expected that once the appropriate magnetic nanofluid characteristics are established, it will offer an easier way of obtaining the transformer core compared to a solid one. From the operating point of view, it is expected that by replacing the solid core with a liquid core will result in a better heat dissipation and reduction of the thermal stresses in the micro-transformer, leading to a longer life-cycle, maintaining or even improving the electric characteristics. The results obtained in 2016 were disseminated through:

- one patent application: A/00713 /07.10.2016 (OSIM, RO), entitled "Planar transformer with magnetic nanofluid"; Authors: PISLARU – DANESCU L., POPA M., ILIE C.I., CHIHAI A R.A., BABUTANU C.A., NICOLAE S., BUNEA F., STOIAN F.D., HOLOTESCU S., MARINICA O.-M., MOREGA A.-M., MOREGA M., DUMITRU J.B., POPA N.C.; Owners: ICPE-CA Bucharest and UPT.
- a conference paper: Nicolae Calin POPA, Ladislau VEKAS, Nicolae CRAINIC, Floriana Daniela STOIAN, Sorin HOLOTESCU, Structural investigation of magnetic nano-fluids used in gravitational generator, presented at the International Conference on Nanotechnology, Nanomaterials & Thin Films for Energy Applications, Liverpool, UK, 27 – 29 July 2016.

Applicability and transferability of the results

The product can bring added value for further development as an end-product to the industrial partner. Possible applications are characterized by their placement in hard to reach places, isolated and without local and/or conventional sources. Among these are applications for industrial automation, monitoring of various parameters in industry (pressure transducers mounted in the gas distribution networks, device multiparameter probes mounted in drinking water distribution networks and others), in agriculture (humidity and soil temperature sensors), for surveillance and monitoring of perimeters.

Financed through/by

Ministry of National Education through the Executive Agency for Higher Education, Research, Development and Innovation Funding, Partnerships in priority S & T domains Program PN II, Joint Applied Research Projects PCCA 2013.

Research centre

Research Center for Engineering of Systems with Complex Fluids, Politehnica University of Timisoara,
URL: <http://mh.mec.upt.ro/ccisfc/>



Research team

The research team of Politehnica University of Timisoara is consisting of three senior researchers, one PhD student and two research assistants:

Assoc. Prof. Dr. - Eng. Floriana D. STOIAN – Project responsible for Partner 1,
Lect. Dr.- Eng. Math. Sorin HOLOTESCU,
Phys. Oana MARINICA,
Assoc.Prof. Dr.- Eng. Nicolae CRAINIC,
Res. Assist. Florica BALANEAN,
Res. Assist. George GIULA.

Contact information

Assoc. Prof. Floriana D. STOIAN, PhD
Department of Mechanical Machines, Technology and Transportation
/ Research Center for Engineering of Systems with Complex Fluids,
1 Mihai Viteazu Bv., Timisoara 300222, Romania
Phone: (+40) 256 403671; Mobile:(+40) 744 597308
E-mail: floriana.stoian@upt.ro, fdstoian@yahoo.com
Project website:
<http://www.icpe-ca.ro/lib/files/sememms-harvest.pdf>

MITIGATION OF DECELERATED SWIRLING FLOW FROM CONICAL DIFFUSERS USING PULSATING WATER JET

Goal of the project:

The fundamental problem addressed in this project is studying a new control method of decelerated swirling flow. The main goal of this project is to evaluate numerically and experimentally the performance of a new flow control method with pulse water injection. The first goal of the project is to mitigate the low frequency plunging oscillations using axially-injected pulsation jets. The second goal is to minimize the injected discharge during this control. This project attempts to deliver answers to the following questions: Is the pulse water injection a valid control method from experimentally point of view? What is the pulse jet parameters which allow the mitigation/elimination of the VR and the maximum pressure recovery in the cone and what is the optimal jet's discharge value? Are there any technical and economical limits of this method? Which are the advantages (if any) of this method with respect to the previous ones (the jet and hydrodynamic feedback)? Which are the disadvantages (if any) of this method with respect to the previous ones (the jet and hydrodynamic feedback)? An existing test rig from Politehnica University of Timisoara is going to be used for experimental investigation of this method (Fig. 1).



Short description of the project:

The new control method consists in injecting a pulsating axial water jet in order to mitigate the low frequency plunging oscillations. The idea of using pulsating jets is yielded by the measured pressure's low-frequency oscillation in the conical diffusers of hydraulic turbines which are operated at part load. These regimes are imposed by the power network requirements. The fixed blade turbines e.g. Francis type, operating at part load present a high level of swirling

flow at the inlet of draft tube. When swirling flow from draft tube is decelerating, it becomes unstable giving rise at helical vortex (or vortex rope). Vortex rope is the main cause for the occurrence of pressure fluctuations in draft tube of hydraulic turbines operating at part load. Mitigating the vortex rope phenomenon is an open problem for modern Francis hydraulic turbines. Numerous techniques have been examined for reducing these effects, with success varying widely. Two types of pressure fluctuations associated with the draft tube surge are identified in the literature. The first is an asynchronous pressure fluctuation due to the precession of the helical vortex around the axis of the draft tube. The second type is synchronous fluctuations who give rise to power fluctuations. Consequently, these low-frequency pressure oscillations will be mitigated using the pulsating axial jet control method.

Project implemented by

Politehnica University Timisoara, Research Center for Engineering of Systems with Complex Fluids

Implementation period:

01.10.2015-30.09.2017

Main activities:

- 1) Objective I: 3D numerical analysis of swirling flow using pulsating jet injection method,
- 2) Objective II: Manufacturing and implementing on the rig of Rotating Pulsating Jet Device,
- 3) Objective III: Experimental campaign for pulsating jet parameters optimization,
- 4) Objective IV: Validation of experimental vs. numerical data.

Results:

The results for 2016 are presented in the list of papers:

1. C. TANASA, T. CIOCAN, S. MUNTEAN and R. SUSAN-RESIGA, (2016), Numerical Assessment of Decelerated Swirling Flow with Vortex Rope from Conical Diffuser Using Pulsating Water Jet, 19th International Seminar on Hydropower Plants, Vienna, 09-11, November.
2. SUSAN-RESIGA Romeo-Florin, MUNTEAN Sebastian, TĂNASĂ Constantin, BOSIOC Ilie Alin, CIOCAN Tiberiu, POPESCU Constantin, (2016), ECHIPAMENT PENTRU CONTROLUL INSTABILITĂȚILOR CURGERILOR CU VĂRTEJ DIN DIFUZORUL CONIC AL TURBINELOR HIDRAULICE, patent application no. A0038/12.05.216 - in romanian.

Applicability and transferability of the results:

A new control method is promoted in this project which attempt to improve the flow control and mitigate the axial pressure pulsations revealed by previous investigations. The decelerated flow control using pulsating jets is a new idea. This new control method will mitigate the low frequency pressure pulsations. These plunging oscillations are dangerous due to the waves traveling along to hydraulic passage. This project will evaluate numerically and experimentally the performance of a new decelerated flow control method: using pulse water injection. Decelerated flow control is a problem experienced by hydraulic turbines when operating far from their best efficiency point as a request from energy market demands. Operating in such a regime (if even possible) causes severe vibrations, efficiency decrease, material fatigue, breaks blades etc. Implementation of a decelerated flow control system able to eliminate vibrations leads to maintenance and operation costs decrease. The method which will be tested on the experimental test rig will be proposed for using in real power plants from the national company SC Hidroelectrica SA Romania, which is partner in different contracts in the field of hydraulic machinery with our institution.

Financed through/by

Unitatea Executiva pentru Finantarea Invatamantului Superior, a Cercetarii Dezvoltarii si Inovarii UEFISCDI

Research Center

Research Center for Engineering of Systems with Complex Fluids

Research team

1. Tanasa Constantin, Director de Proiect
2. Ciocan Tiberiu, Cercetator Postdoctoral
3. Bosioc Ilie Alin, Cercetator Postdoctoral
4. Popescu Constantin, Student Doctorand
5. Predoiu Ionut-Costinel, Student Doctorand
6. Mos Daniel, Student Masterand
7. Muntean, Sebastian, Cercetator Senior
8. Todiruta Mariana, Cercetator Senior
9. Szakal Raul-Alexandru, Student Masterand

Contact information

Dr. Constantin TANASA, CSIII
Mechanical Engineering Faculty/Hydraulic Machinery Department,
Address: M. Viteazu, No. 1, Timisoara
Phone: (+40) 256403692
E-mail: constantin.tanasa@upt.ro
Web: <http://mh.mec.upt.ro/RPJD-DJPR/#/login>

IONOSPHERIC PROPAGATION PREDICTIONS AND WIDEBAND COMMUNICATIONS USING HF SDR SENSORS FOR INFORMATIONAL SUPPORT IN EMERGENCY SITUATIONS IN ROMANIA

Goal of the project

The project aims to implement software and hardware solutions that integrate ionospheric sounding algorithms in a network of SDR (Software Defined Radio) sensors in order to develop and validate a HF (High Frequency) ionospheric prediction model for the territory of Romania

Short description of the project

The project targets a systemic approach of the communication network through the implementation, development and integration of recent technological solutions from the perspective of providing information support for the management of interventions in disaster areas, where communication infrastructure does not exist or is damaged. Project results can be applied not only to the rapid resolution of remote communications in emergency situations, but also can be extended to other applications in the HF communications range, such as encrypted data communication links for the government or the military

Project implemented by:

- Land Forces Academy "Nicolae Bălcescu", Sibiu - coordinator
- Interactive Systems & Business Consulting, Bucharest - partner
- Politehnica University Timișoara - partner
- Technical University of Cluj-Napoca - partner

Implementation period

21.11.2014 - 30.06.2016

Main activities

- Building a SDR sensor network for ionospheric sounding
- Elaboration of an application for HF propagation predictions in Romania.
- Development of broadband HF communications by the implementation of adaptive systems



Results

The main deliverables of the project are:

- an ionospheric model which is specific for Eastern Europe;
- algorithms for the automatic identification and classification of waveforms in order to increase the transfer rate and to implement techniques for dynamically accessing the HF resources;
- SDR solutions for local monitoring and collaborative spectrum sensing in the HF range;
- a HF radio network on the territory of Romania which allows high transfer rates in collaborative environments, by automatically adapting to specific conditions of ionospheric propagation at high angles of elevation.

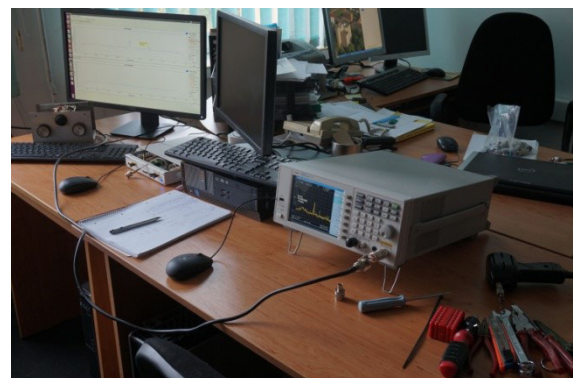

Equipment

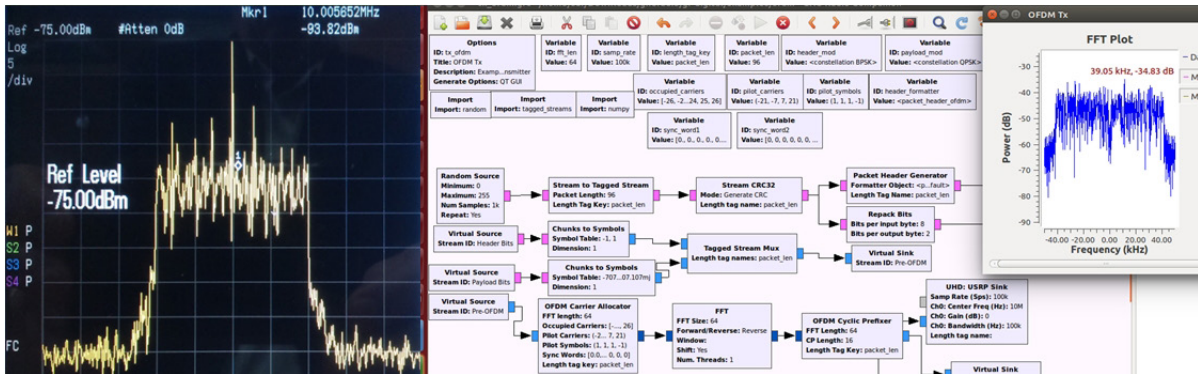

Generation of an OFDM signal

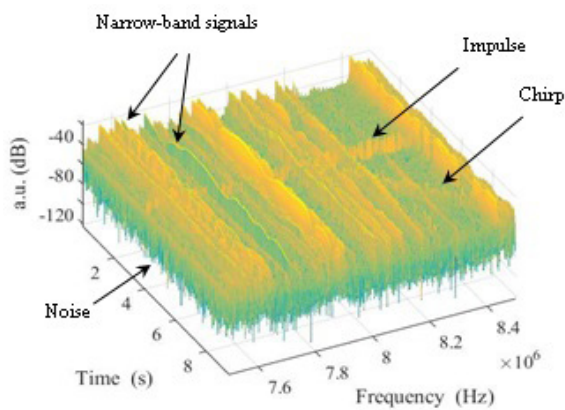

Time-frequency representation of an acquired signal

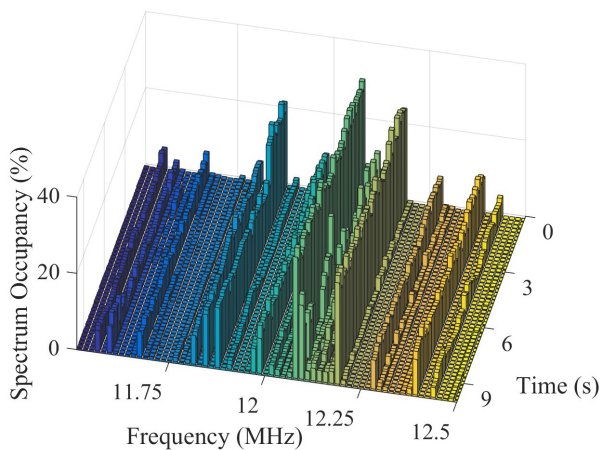

Spectrum occupancy.

Applicability and transferability of the results

- creating an integrated software application for HF propagation predictions adapted to the propagation particularities of our country
- developing localization algorithms used in OTH (Over-The-Horizon) radar systems
- establishing a tracking system in the HF range using SSL (Single Site Location) technology
- implementing the ionospheric measurement capability for HF radio stations with SDR architecture
- implementing algorithms for the adaptation of broadband waveforms to the ionospheric channel status
- developing a HF radio transceiver with cognitive capabilities
- implementing an integrated system for monitoring the ionosphere

Financed through/by

PN-II-PT-PCCA-2013-4

Research team

Prof. dr. eng. Aldo De Sabata
 Assoc. prof. dr. eng. Septimiu Mischie
 Assist. lect. dr. eng. Cornel Balint
 Assist. lect. dr. eng. Ciprian Dughir
 Assist. lect. dr. eng. Cora Iftode

Contact information

Prof. Aldo DE SABATA, PhD
 Faculty of Electronics and Telecommunications / Department of Measurement and Optical Electronics
 Address: Bd. V. Parvan nr. 2, 300223 Timisoara
 Phone: (+40) 256 403 370
 Mobile:
 E-mail: aldo.de-sabata@upt.ro

MICRO-MECHANICAL MODELLING OF CELLULAR MATERIALS WITH REFINEMENTS ON FRACTURE AND DAMAGE

Goal of the project

Cellular materials are widely used as cores in sandwich composites, for packing and cushioning. The main characteristics of foams are light weight, high porosity, high crushability and good energy absorption capacity. Present project propose to develop micro-mechanical models in order to predict the mechanical properties of cellular materials with a focus on modeling the fracture and the influence of damage on the mechanical response.

Short description of the project

Project combines analytical, numerical and experimental methods for describing mechanical behavior of cellular materials.

Project implemented by:

Universitatea Politehnica Timisoara

Implementation period

05.10.2011 – 30.11. 2016

Main activities

- Better understanding of mechanical behavior of cellular materials.
- Develop micro-mechanical models to estimate mechanical properties of cellular materials.
- Implementation of constitutive material models in Finite Element Analysis.
- Investigating the size effect and notch effect on cellular materials Evaluating the behavior of cellular materials under dynamic (impact and fatigue) loading.
- Identification of damage mechanisms in cellular materials using Digital Image Correlation and Thermography.
- Investigating the effect of microstructural damage on the mechanical properties of cellular materials.
- Applixations of cellular structures in sandwich structures and sport industry.

Results

Dissemination of results in ISI journals

1. L. Marsavina, E. Linul, T. Voiconi, T. Sadowski, A comparison between dynamic and static fracture toughness of polyurethane foams, POLYMER TESTING, 32, 673-680, 2013 (IF 2.35)
2. L. Marsavina, D.M. Constantinescu, E. Linul, D.A. Apostol, T. Voiconi, T. Sadowski, Refinements on fracture toughness of PUR foams, ENGINEERING FRACTURE MECHANICS, 129, 54-66, 2014 (IF 2.024)
3. E. Linul, L. Marsavina, Assessment of sandwich beams with polymeric foam core using failure-mode maps, PROCEEDINGS OF ROMANIAN ACADEMY A, Vol. 16(4), p. 522-530, 2015 (IF 1.735)
4. Serban D., Linul E., Marsavina L., Modler N., Numerical evaluation

- of two-dimensional micromechanical structures of anisotropic cellular materials: case study for polyurethane rigid foams, IRANIAN POLYMER JOURNAL, Vol. 24 (6), p. 515-529, 2015 (IF 1.684)
5. Marsavina L., Constantinescu D. M., Linul E., Voiconi T., Apostol D., Shear and mode II fracture of PUR foams, ENGINEERING FAILURE ANALYSIS, Vol. 58 (Part 2), p. 465-476, 2015 (IF 1.358)
6. Negru R., Marsavina L., Voiconi T., Linul E., Filipescu H., Belgiu G., Application of TCD for brittle fracture of notched PUR materials, THEORETICAL AND APPLIED FRACTURE MECHANICS, Vol. 80 (Part A), p. 87-95, 2015 (IF 2.025)
7. Serban D., Marsavina L., Modler N., Low-cycle fatigue behaviour of polyamides, FATIGUE & FRACTURE OF ENGINEERING MATERIALS & STRUCTURES, Vol. 38 (11), p. 1383-1394, 2015 (IF 1.838)
8. Marsavina L., Kovacik J., Linul E., Experimental validation of micromechanical models for brittle aluminium alloy foam, THEORETICAL AND APPLIED FRACTURE MECHANICS, Vol. 83, p. 11-18, 2016 (IF 2.025)
9. Serban D., Voiconi T., Linul E., Marsavina L., Modler N., Viscoelastic Properties of PUR Foams Impact excitation and dynamic mechanical analysis, MATERIALE PLASTICE, 52 (4), p. 537-541, 2015. (IF 0.903)
10. Serban D., Weissenborn O, Geller S., Marsavina L., Gude M., Evaluation of the mechanical and morphological properties of long fibre reinforced polyurethane rigid foams, POLYMER TESTING, 49, 121-127, 2016 (IF 2.35)
11. Marsavina L., Constantinescu D.M., Linul E., Apostol D.A., Voiconi T., Experimental and numerical crack paths in PUR foams, ENGINEERING FRACTURE MECHANICS, 167, p. 68-83, 2016, (IF 2.024)
12. Linul E., Marsavina L., Kovacik J., Sadowski T., Dynamic and Quasi-Static compression tests of closed-cell aluminium alloy foams, PROCEEDINGS OF ROMANIAN ACADEMY A, Accepted manuscript, 2016. (IF 1.735)
13. Apostol D., Stuparu F., Constantinescu D. M., Marsavina L., Linul E., Crack length influence on stress intensity factors for the asymmetric four-point bending testing of a polyurethane foam, MATERIALE PLASTICE, 53 (2), p. 280-282, 2016. (IF 0.903)
14. Linul E., Serban D., Marsavina L., Kovacik J., Low-cycle fatigue behaviour of ductile closed-cell aluminium alloy foams, FATIGUE & FRACTURE OF ENGINEERING MATERIALS & STRUCTURES, On Line accepted Manuscript, 2016, doi: 10.1111/ffe.12535 (IF 1.838).

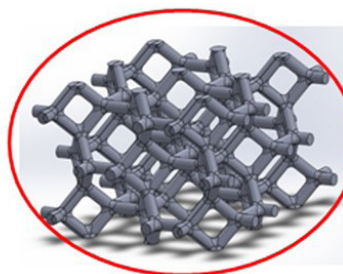

cellular structure

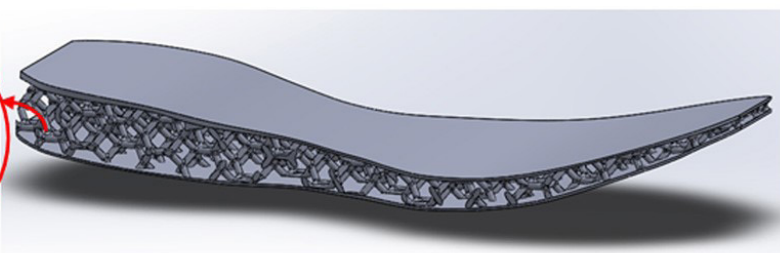

sole with cellular core

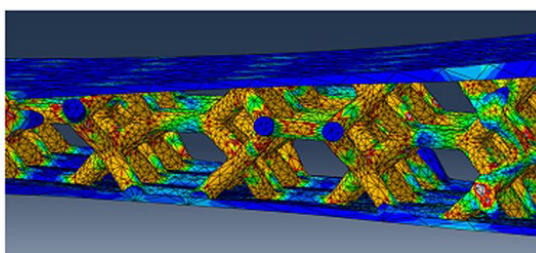

displacement results

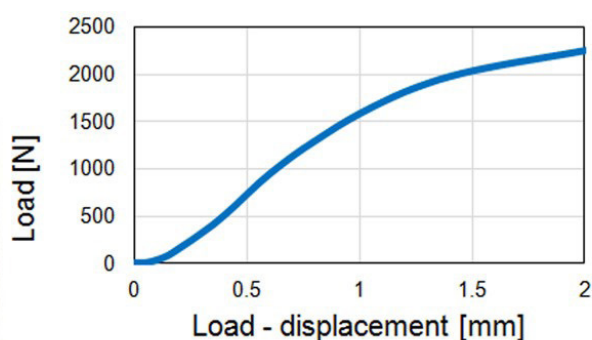

load - displacement response of sole

Results on mechanical behavior of sole with cellular structure core

Applicability and transferability of the results

Results will be transferred to foams manufacturers to improve their manufacturing process. Also, companies using foam components and cellular structures (shoes industry) will benefit by our developed micro-mechanical models to characterise their components and in the product design.

Financed through/by

Grant PN-II-ID-PCE-2011-3-0456, Contract Nr. 172/2011, by Romanian Ministry of National Education, through UEFISCDI

Research Center

ICER

Research team

Prof. Dr. Eng. Liviu Marsavina – Project Manager
 Prof. Dr. Eng. Dan M. Constantinescu – Senior Researcher
 Dr. Eng. Emanoil Linul – Postdoctoral Researcher
 Dr. Eng. Dragos A. Apostol – Postdoctoral Researcher
 Dr. Eng. Dan A. Serban – Postdoctoral Researcher
 Dr. Eng. Florin Stuparu – PhD student

Contact information

Prof. Liviu MARSAVINA, PhD
 Faculty Mechanical Engineering
 Department Mechanics and Strength of Materials
 Address: Blvd. M. Viteazu, No. 1, 300222 Timisoara
 Phone: (+40) 256 403 577
 Mobile: (+40) 726 397 635
 E-mail: liviu.marsavina@upt.ro
 Web: http://www.marsavina.ro/index_MMMCM.html

HIGH PERFORMANCE LIGHTWEIGHT PANELS WITH A NEW OPTIMIZED DESIGN FOR ADVANCED AIRCRAFT STRUCTURES

Goal of the project

The goal of the project is the design, fabrication and testing of the new flat and curved aircraft panels having better characteristics, as follows:

- fabrication of the experimental models for both plane and curved sandwich panels;
- 3D modeling for linear and nonlinear analysis in order to characterize the new sandwich panels;
- static testing of the experimental new models.

Short description of the project

Design of aircraft panels, made of metal and composite material, flat and curved, with improved performances.

Project implemented by:

- University Politehnica Bucuresti - Coordinator
- Straero S.A - Partner 1
- University Politehnica Timisoara - Partner 2
- INAS S.A. - Partner 3
- SMART Mechanics S.R.L. - Partner 4

Implementation period

02.07.2012 - 30.10.2016

Main activities

1. Bending static tests on two type of specimens cut out from flat sandwich panels: PSP 1 (figure 1) with a compact core and PSP 2 (figure 2) with the core having circular holes;
2. Bending static tests on MEC 2 (figure 3) curved sandwich panels;
3. Stability tests on MEC 2 curved panels;
4. Numerical simulation of the mechanical behavior of tested sandwich structures;
5. Dissemination of the results.

All the specimens were made using polyurethane foam cores with density 300 kg/m^3 , aluminum alloy 1050 H24 for faces, and adhesive AW 106/HV 953U.

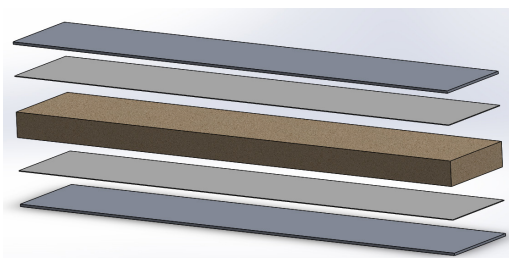

Fig. 1. PSP 1 panel

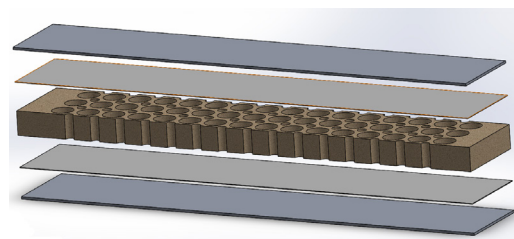

Fig. 2. PSP 2 panel

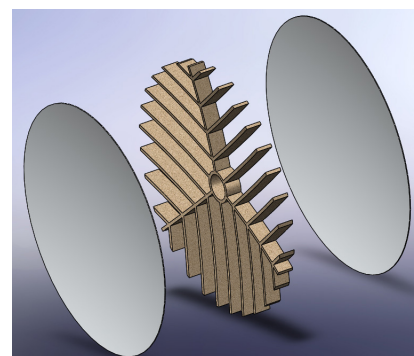

Fig. 3. MEC 2 panel

Results

1. Determination of strength and stiffness of the investigated sandwich structures;
2. Identification of the failure modes of the sandwich structures loaded in bending (figure 4);
3. Characterization of the mechanical behavior of the sandwich structures using the digital image correlation technique;
4. Numerical simulation of the mechanical response for tested sandwich structures.

The main publications are:

1. Negru R., Marsavina L., Hluscu M. (2016) Experimental and numerical investigations on adhesively bonded joints, IOP Conf. Series: Materials Science and Engineering, vol. 123 012012 (3rd International Conference on Competitive Materials and Technology Processes IC-CMTP3, Miskolc-Lillafüred, Hungary, October 6-10, 2014);



Fig. 4a. face indentation (PSP 1)



Fig. 4b. face yield (PSP 1)



Fig. 4c. core fracture (PSP 2)

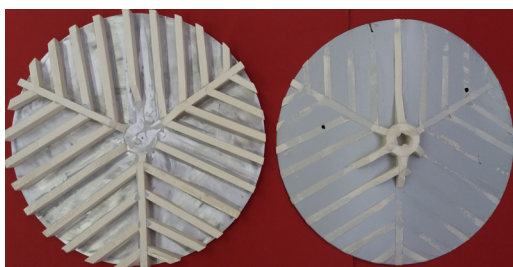

Fig. 4d. core shear (MEC 2)

2. Șerban D., Linul E., Sărăndan S., Marsavina L. (2016) Development of parametric Kelvin structures with closed cells, Solid State Phenomena, vol. 254 pp 49-54, Trans Tech Publications, Switzerland (AMS'15 Advanced Materials and Structures, Timișoara, România, October 16-17, 2015);
3. Negru R., Șerban D., Marsavina L., Magda A. (2016) Lifetime prediction in medium-cycle fatigue regime of notched specimens, Theoretical and Applied Fracture Mechanics 84, 140-148.

Applicability and transferability of the results

Results and design solutions will be transferred to sandwich structure manufacturers to improve their technologies. In addition, companies involved on design of aircraft will benefit by our developed sandwich structures and hybrid assembly solutions.

Financed through/by

PN-II-PT-PCCA-2011-3.2-0068 CONTRACT 206/2012, EXECUTIVE AGENCY FOR HIGHER EDUCATION, RESEARCH, DEVELOPMENT and INNOVATION FUNDING (UEFISCDI)

Research Center

“Șt. Nădășan” Research Laboratory for Strength, Integrity and Durability of materials, structures and conductors, <http://erris.gov.ro/St-Nadasan-Research-Laborato>

Research Team for Partner 2

Prof. Dr. Eng. Liviu Marsavina
Prof. Dr. Eng. Nicolae Faur
Dr. Eng. Radu Negru
Dr. Eng. Dan Andrei Șerban
Dr. Eng. Anghel Cernescu
Dr. Eng. Mihai Hlușcu

Contact information

Prof. Liviu MARSAVINA, PhD
Faculty Mechanical Engineering
Department of Mechanics and Strength of Materials
Address: Blvd. M. Viteazu, No. 1, 300222 Timișoara
Phone: (+40) 256 403 577
Mobile: (+40) 726 397 635
E-mail: liviu.marsavina@upt.ro
Web: <http://www.marsavina.ro>

CENTRALIZING AND OPTIMIZING SCADA IN THE WATER SECTOR (CASCADA)

Goal of the project

The knowledge transfer to Aquatim through software and hardware modules and strategies for centralizing and optimizing SCADA for the water sector.

Short description of the project

The general purpose of CASCADA is the knowledge transfer to the economic operator through software and hardware modules and strategies to solve stated problems in centralizing and optimizing SCADA for the water sector. The project proposes the ICOM module (Interface, Conversion, Optimization, Modularity) as instrument in solving both interfacing and protocol conversion problems and the development of non-invasive optimization modules of controlling groups of objectives already in function in the water sector. Also, in order to improve effectiveness, the project addresses the IGSS SCADA implementation strategy in Aquatim control center and the existing communication system. CASCADA wants to train Aquatim in SCADA/automation/communications new technologies and to practically apply the concepts in a SCADA analysis of three existing objectives of the operator.

Project implemented by

University Politehnica Timisoara

Implementation period

30.09.2016-30.09.2018

Main activities:

The activities are foreseen to implement the following three objectives:

- 1) Realizing and testing the ICOM module;
- 2) Optimizing the IGSS control center;
- 3) Direct knowledge transfer in new technologies.

Results

CASCADA, through the ICOM module will solve the SCADA integrability problems of the economic operator, respectively will provide an instrument, independent of local equipment and SCADA solutions, to answer integrability and functioning optimization issues for groups of interdependent objects as technological flow but independent regarding their implementations. Therefore, due to SCADA correlations of groups of objects (integrations on higher SCADA levels and creating control algorithms for group of objects), the economic operator's systems will be more stable and efficient, respectively the impact of the incidents will be reduced. Optimizing the IGSS control center will provide the possibility to

maximally use the resources available through licensing, an increased communication speed through systematizing the internal Aquatim network, respectively an adequate web based access conferred by the WebNavIGSS module.

CASCADA will impact also the quality of the future investments of the economic operator through opening perspectives to new technologies and optimal solutions, with increased efficiency and reduced costs.

The implemented activities will strengthen the entrepreneurial abilities of researchers and the connection between the academic environment and the industry requirements.

Applicability and transferability of the results

As a bridge grant, the project is strongly industry oriented, with significant practical value and focused on the knowledge transfer to an economic operator.

Financed through/by

UEFISCDI

Research Centre

ICER – Renewable energy research institute

Research team

Adrian Ștefan KORODI
Ioan SILEA
Octavian ȘTEFAN
Ruben Dan CRIȘAN
Teodor HUPLE
Alexandra-Ionela BASSO-ȚIDREA
Mihaiță-Alin RADU
Mihaela Marcella CRIȘAN-VIDA
Oana-Sorina CHIRILA

Contact information

S.L. Adrian Ștefan KORODI, PhD
Faculty of Automation and Computers,
Department of Automation and Applied Informatics
Address: Str. V. Parvan, No. 2, 300223, Timisoara
E-mail: adrian.korodi@upt.ro

MESSAGE PASSING ITERATIVE DECODERS BASED ON IMPRECISE ARITHMETIC FOR MULTI-OBJECTIVE POWER-AREA-DELAY OPTIMIZATION

Goal of the project

The DIAMOND project proposes to exploit the robustness of modern decoders to arithmetic inaccuracies, for improving their latency and power consumption. The project focuses on Low-Density Parity-Check (LDPC) codes widely used in modern communication systems, and targets the design of message-passing iterative decoders using imprecise arithmetic units. We aim at harnessing the inaccuracies produced by imprecise computational units, while benefiting of their significant reductions in area, latency and power consumption.

Short description of the project

The project investigates the possibility of optimizing LDPC decoding architectures by employing imprecise and approximate techniques at different levels: message representation, processing unit and architecture.

Project implemented by

- Universitatea Politehnica Timisoara (UPT) – Romanian partner
- CEA-LETI, Grenoble – French coordinator partner
- ETIS Laboratory – French partner

Implementation period

March 2014 – March 2017

Main activities:

DIAMOND project have analyzed the impact of the introducing impreciseness and approximations in LDPC decoding architecture on the decoding performance, cost and throughput. The main activities involved:

1. Development of LDPC decoding techniques using imprecise message representation
2. Analysis and development of imprecise processing units
3. Development of imprecise stopping criteria for layered decoding
4. Development of proof-of-concept decoders using the imprecise techniques at different levels.

Results

The main results of the DIAMOND project include:

1. Imprecise message representation techniques – these include the development of the modified offset min-sum (MOMS) LDPC decoding, as well as the non-subjective finite alphabet iterative decoding of LDPC codes.
2. Imprecise processing units – the main developments have consisted in a novel check node unit using one-hot representation of messages, and a novel version of self-correcting min-sum (SCMS), that allows the implementation of this SCMS based LDPC decoder with a similar cost as the Min-Sum based ones.
3. Imprecise early termination criteria for layered LDPC decoders

In order to provide a wide range of proof-of-concept decoding architectures, for which a wide range of architecture and code parameters can be analyzed, an integrated environment for the architecture generation, verification and implementation – TEDI – has been developed.

Applicability and transferability of the results

The DIAMOND project aims at optimizing LDPC decoding architectures used for forward error correction in both wireless communications and data storage. Several steps for economic and industrial results dissemination have been undertaken. On one hand, a simplified version of the LDPC decoding architecture generator has been made publicly available on the webpage dbyalick.cs.upt.ro. On the other hand, the proposed stopping criteria for layered LDPC decoding architectures has been considered for a joint patent application between the project partners.

Financed through/by

UEFISCDI – Romanian funding agency
ANR – French funding agency
Romanian project number: PN-II-ID-JRP-RO-FR-2012-0109

Research Centre

Research Centre in Computing and Information Technology – CCCTI

Research team

Dr. Oana Boncalo – Principal Investigator
Dr. Petru Mihancea
Ioana Mot
Gyorgy Kolumban Antal
Petra Csereoka

Contact information

Oana Boncalo, PhD
Department of Computer and Information Technology
Address: Vasile Parvan Blvd., Nr. 2, 300223, Timisoara
Phone: (+40) 256 403264
E-mail: oana.boncalo@cs.upt.ro
Web: <http://staff.cs.upt.ro/~boncalo/diamond/contact.html>

DIVIDEND - DISTRIBUTED HETEROGENEOUS VERTICALLY INTEGRATED ENERGY EFFICIENT DATA CENTRES

Goal of the project

DIVIDEND aims to optimize heterogeneous data centers, combining CPUs, GPUs, and task-specific accelerators, as a unified entity to the application developer and let the runtime optimize the utilization of the system resources during task execution. DIVIDEND embraces heterogeneity to dramatically lower the energy per task through extensive hardware specialization while maintaining the ease of programmability of a homogeneous architecture.

Short description of the project

DIVIDEND provides cross layer energy monitoring and management in data centers that use heterogeneous CPU, GPU and FPGA based processing. We aim to provide energy optimization using a vertical based integration from different abstraction layers: hardware, operating system, compiler and application.

Project implemented by

- University of Edinburgh – Coordinator
- University of Lancaster
- Queens University of Belfast
- Ecole Polytechnique Federale de Lausanne
- Universitatea Politehnica Timișoara
- INRIA Paris,
- Advanced Micro Devices, Paris

Implementation period

May 2015 – May 2017

Main activities:

The main activities performed in UPT are related to the development and integration of energy monitoring of dedicated FPGA accelerators into the Distributed Heterogeneous System Architecture (DHSA) concept. The UPT research represents the first approach to use the FPGA accelerators in hybrid architecture with full access to the system shared memory, as well as complete queuing support for DHSA. We aim at providing efficient acceleration for irregular parallel application using the proposed approach.

Results

The DIVIDEND project has provided a complete integration of FPGA based application accelerators into the DHSA systems, by offering the required hardware, as well as driver and operation system level support. Furthermore, energy accounting for dedicated FPGA hardware accelerators for distributed applications is offered. Therefore, an energy aware FPGA acceleration in distributed HSA based heterogeneous CPU-GPU-FPGA systems has been developed.

Applicability and transferability of the results

The DIVIDEND project developed the first approach that provides an energy cost for an application that has been executed in the distributed data center, composed of a heterogeneous computation platform consisting of CPUs, GPUs, or FPGAs. Therefore, for each user which runs applications on a data-center, a cost for the execution of each task can be offered. Therefore, the DIVIDEND project offers an energy aware application execution framework on distributed data-centers.

Financed through/by

CHIST-ERA NR 5/2015

Research Centre

Research Centre in Computing and Information Technology – CCCTI

Research team

Dr. Alexandru Amaricai – Principal Investigator
 Prof. Marius Marcu
 Dr. Sebastian Fuicu
 Dr. Cosmin Cernazan
 Dr. Sergiu Nimara
 Gyorgy Kolumban Antal

Contact information

Alexandru Amaricai, PhD
 Department of Computer and Information Technology
 Address: Vasile Parvan Blvd., Nr. 2, 300223, Timișoara
 Phone: (+40) 256 403272
 E-mail: alexandru.amaricai@cs.upt.ro

NEW APPROACH OF USING IONIC LIQUIDS (ILS) AS GREEN EXTRACTANTS IN THE ADSORPTION PROCESS OF RADIONUCLIDES FROM WASTE AQUEOUS SOLUTIONS

Goal of the project:

The overall goal of the proposed project is to investigate a new approach of using the room temperature ionic liquid (RT IL) as extractants impregnated onto various solid supports in the adsorption process of radionuclides from waste aqueous solutions. The project has an interdisciplinary character presenting an integrated concept of waters depollution with radionuclides content

Short description of the project

Various ionic liquid impregnated materials are obtained and after a complex characterization they are used in the adsorption process of different radionuclides from synthetic and real aqueous solutions.

Project implemented by

Faculty of Industrial Chemistry and Environmental Engineering

Implementation period

01.05.2013 - 30.09.2016

Main activities

1. Impregnation of various ILs onto various solid supports using various methods of impregnation (2013);
2. Characterization of the obtained ionic liquid impregnated materials (2013);
3. Removal of various radionuclides from aqueous solutions through adsorption onto obtained ionic liquids impregnated materials: batch studies - equilibrium, kinetic and thermodynamic studies. (2013, 2014);
4. Removal of various radionuclides from aqueous solutions through adsorption onto obtained ionic liquids impregnated materials: Column studies (2015);
5. The influence of competitive cations (eg. Na, K and Be) and the concomitant extraction of various radionuclides (2015, 2016);
6. Desorption of the radionuclides and recycle of ionic liquid impregnated material. Use of various cycle adsorption-desorption (2015; 2016)

Applicability and transferability of the results

The project topic is answering a well-defined problem/question with practical relevance – in the waters depollution with radionuclides content, opening and establishing the new science based on both adsorption technology and ionic liquids. The results may also be transferred to the students as part of their training in the field of water and waste water treatment, adsorption process and obtaining of new functionalized materials field.

Results

The use of ionic liquid impregnated materials as adsorbents in the removal process of radionuclides from aqueous solutions presented very good performance in the removal process of radionuclides from waste aqueous solutions because the adsorbent properties of the solid supports and the advantageous properties of ILs were combined. All results were validated by publication in scientific journals and presentation at scientific conferences: 6 articles published in ISI indexed journals, 5 articles published in BDI indexed journals, and 19 articles presented at international conferences, one patent application.

Financed through/by

UEFISCDI/Human Resources - Research projects to stimulate the establishment of young independent research - TE

Research Centre

Research Institute for Renewable Energy

Research team

Lecturer Lavinia Lupa, PhD
Prof. Petru Negrea, PhD
Assoc. Prof. Adina Negrea, PhD
Scientific Researcher Mihaela Ciopec, PhD
Lecturer Raluca Vodă, PhD
Eng. Alexandra Bogin

Contact information

Lecturer Lavinia LUPA, PhD
Department of Applied Chemistry and Inorganic Compounds and Environmental Engineering
Address: Bd. Vasile Pârvan, No. 6, RO 300223, Timisoara
Phone: (+40) 256 404 192
Fax (+40) 256 403 060
E-mail: lavinia.lupa@upt.ro
Web: http://www.chim.upt.ro/Facultatea-de-Chimie-Industrială-si-Ingineria-Mediului_PN-II-RU-TE-2012-3-0198_2XW.html

ECO-EFFICIENT RECOVERY OF WASTES FROM HOT DIP GALVANIZING PROCESS AS ANIONIC CLAYS APPLICABLE FOR REMOVAL OF UNDESIRABLE COMPOUNDS FROM WATER

Goal of the project

The main objective of the project is the synthesis of anionic clays (layered double hydroxides) from wastes of hot dip galvanizing process (zinc ash and sludge from wastewater treatment) and the utilization of these materials in removal processes (adsorption or photocatalysis) of undesirable compounds from water (i.e. phenols, dyes, chromate). Another objective is to gain significant research experience for the project team.

Short description of the project

By treatment of industrial wastes some layered double hydroxides (LDH) will be prepared. The correlation between the chemical characteristics of precursors of LDH obtained from wastes and the performances of LDHs in removal processes of undesirable compounds from water will be clarified.

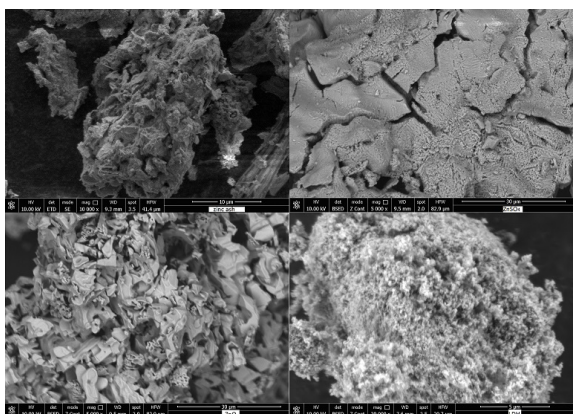

Figure 1. SEM images of zinc ash and product obtained after zinc ash treatment ($ZnSO_4$, ZnO and LDH)

Project implemented by

Faculty of Industrial Chemistry and Environmental Engineering

Implementation period

01.10.2015 – 30.09.2017

Main activities:

1. The influence of the working parameters of wastes treatment process on the chemical characteristic of the obtained metal solutions;
2. The influence of the chemical characteristics of solution precursors on the morphological and surface properties of the synthesized LDH;
3. The performances of the synthesized LDH in the sorption and photocatalytic processes for removal of undesirable compounds from water.

Results

1. Method for valuable metal recovery from wastes of hot dip galvanizing process.
2. New method for anionic clay synthesis from metal ions recovered from wastes of hot dip galvanizing process.
3. Method for removal of undesirable compounds from water by anionic clays synthesized from wastes of a "dirty industry".

Applicability and transferability of the results

By applying this approach, the wastes of a "dirty industry" (hot dip galvanizing process) are treated and a valuable product is added, keeping in mind that the anionic clays have multiple utilizations at industrial scale as plastic additives, as flame retardant and as anions scavengers. The project has an interdisciplinary character presenting an integrated concept of industrial wastes treatment and waters depollution.

Financed through/by

Romanian National Authority for Scientific Research and Innovation, CNCS - UEFISCDI

Research Centre

Research Institute for Renewable Energy

Research team

Assist.Prof. Laura Coheci, PhD
Lecturer Lavinia Lupa, PhD
Lecturer Marius Gheju, PhD
Eng. Delia Andrada Duca, PhD student
Eng. Alin Golban, PhD student

Contact information

Assist.Prof. Laura COCHECI, PhD
Faculty of Industrial Chemistry and Environmental Engineering/
Department of Applied Chemistry and Engineering of Inorganic
Compounds and Environment
Address: Vasile Parvan Bl, No. 6, 300223, Timișoara
Phone: (+40) 256 403069
E-mail: laura.coheci@upt.ro
Web: <https://sites.google.com/site/pniirute20140771/>

SYNERGIC GREEN TECHNOLOGIES FOR TREATMENT OF HEXAVALENT CHROMIUM POLLUTED WATERS

Goal of the project

The first major objective of this project will be to study the influence of co-presence of sand, MnO_2 and sand coated with manganese oxides on Cr(VI) efficiency of removal with metallic iron. The second major objective of this project is to study the immobilization of exhausted reactive mixtures containing Fe, Cr, sand and MnO_2 in vitreous matrices. The Cr, Fe and Mn immobilization in the glass matrix will be analyzed in order to convert the resulting glasses into marketable glazes or bulk glass products.

Short description of the project

The proposed theme is integrated in the thematic area of water and wastewater treatment, with the aim of water reuse, waste recovery and protection of environment quality.

Project implemented by

University Politehnica Timisoara

Implementation period

01.10.2015–30.09.2017

Main activities:

1. Batch treatability experiments. Will be performed using a Berzelius flask containing Cr(VI) solution. Determined amounts of reactive materials are added to the solution and flask contents will be mixed continuously. Aliquots will be periodically extracted and analyzed.
2. Continuous long term column treatability experiments. Will be performed using an experimental setup comprising: columns with reactive material filling; peristaltic pump used to pass the Cr(VI) aqueous solution through the column; storage tank for the Cr(VI) solution. The Cr(VI) solution will be passed through the column packed with reactive material filling. Column effluent samples will be withdrawn at regular time intervals and analyzed.
3. Experiments regarding the synthesis of glasses from wastes. The exhausted reactive materials will be mixed with glass powders and borax and then melted in an electric furnace. In order to obtain bulk glass products the melt is press-quenched between two stainless steel blocks and annealed to remove stress. The granular frits are obtained after pouring the melts in cold water. The glaze slurry is prepared using the obtained frits (95%) and kaolin (5%) as suspension material. The terracotta plates glazed by immersion are dried and then fired at 980°C for 30 min. For the porous glass synthesis a foaming agent (SiC) was added together with the waste glass powder and the exhausted reactive mixtures. The raw materials are mixed together and then uniaxial pressed into cylindrical samples. The samples, dried at 80°C for 12 hours are treated at 900°C for 10 minutes.

Results

The assessment of sand co-presence on Cr(VI) removal with metallic iron.

The assessment of MnO_2 co-presence on Cr(VI) removal with metallic iron.

The assessment of MnO_2 and sand mixtures co-presence on Cr(VI) removal with metallic iron

The immobilization of exhausted reactive mixtures containing sand, Fe and Cr in vitreous matrices.

Applicability and transferability of the results

Treatment of waters polluted with Cr(VI).

Conversion of wastes into marketable glazes or bulk glass products

Financed through/by

Project PNII-RU-TE-2014-4-0508 No. 129/1/10/2015, Synergic green technologies for treatment of hexavalent chromium polluted waters. Total funding: 550000 RON

Research Centre

ICER

Research team

Gheju Marius Traian – Project manager

Balcu Ionel – Postdoctoral researcher

Moşoarcă Giannin Emanuel – Postdoctoral researcher

Vancea Cosmin Nicolae – Postdoctoral researcher

Bălăşoiu-Flueraş Adriana Maria – PhD student

Enache Andreea – PhD student

Contact information

Lecturer Marius GHEJU, PhD

Faculty of Industrial Chemistry and Environmental Engineering/
Department CAICAM

Address: Bd. Vasile Pârvan, nr. 6, 300223 Timișoara, România

Phone: (+40) 256 404185

E-mail: marius.gheju@upt.ro

EXPERIMENTAL MODEL FOR AN AUTOMATIC CAPACITIVE COMPENSATOR DESIGNED FOR IMPROVING THE POWER FACTOR AND FOR LOAD BALANCING IN LOW-VOLTAGE ELECTRICITY DISTRIBUTION NETWORKS - CAEREDJT

Goal of the project

The project is intended to finance industrial research activities, needed to put in practice under the form of an experimental model of research findings of a group of academics from UPT, concerning the network load balancing electric phase through cross unbalanced capacitive compensation. In electrical networks, inductive load variation implies variation of the capacitive compensation, thus the need for building an unbalanced capacitive automatic compensator, to track the load variation.

Short description of the project

The automatically unbalanced capacitive compensator proposed by this project is an innovative product, so achieving a functional experimental model involves overcoming a number of scientific and technical challenges, the most important being: control and single-phase switching of the capacitor batteries steps, the construction algorithm and implementation of a programming language for PLC process control, process optimization for automatic compensation.

Project implemented by

- Politehnica University of Timisoara – Lead partner
- S.C. ICPE S.A. Bucharest – Project partner

Implementation period

01.07.2014 - 30.09.2017

Main activities

1. Conducting studies and analysis on the alternative constructive solutions and developing the technical documentation for the construction of the experimental model.
2. Manufacturing of the experimental model and the analysis, control and monitoring systems.
3. Testing the model and proving its functionality and its utility
4. Dissemination of results and protect the intellectual property rights.

Financed through/by

Executive Unit for Financing Higher Education, Research, Development and Innovation - UEFISCDI

Applicability and transferability of the results

The results of the project are useful for unbalanced electrical loads supplied at low voltage level, and also for the Distribution system operator (DSO).

Results

- The main outcome of the project will be a functional experimental model and its documentation of implementation for a capacitive compensator designed to improve power factor and load balancing in networks of low voltage power distribution.
- It will underpin the design and construction in a later stage, of a prototype of a capacitive automatically balance high power compensator (tens of kVA) for increasing network performance of low-voltage power distribution and utilization facilities connected to it, by reducing reactive power flow and load balancing.
- The results of the research will be disseminated in scientific papers in professional journals or communication conferences.
- New technical solutions brought by this automatic capacitive compensator, as regard to the structure, order, sizing, automatic control algorithm, will be the subject of intellectual property protection activities.

Research Centre

Analysis and Optimization of the Electrical Power Systems Regimes

Research team

Assoc.Prof. Adrian Pană, PhD
 Prof. Radu - Emil Precup, PhD
 Prof. Ștefan Preitl, PhD
 As. Florin Molnar-Matei, PhD
 As. Alexandru Băloi, PhD
 Lecturer Ilie Mihai Tăcucean, PhD
 Lecturer Mircea-Bogdan Rădac, PhD
 As.Claudia-Adina Bojan-Dragoș, PhD
 Alexandra Lulia Stînean, PhD
 Eng. Andrei Plettinger

Contact information

Assoc. Prof. Adrian PANĂ, PhD
 Department of Power Engineering
 Address: Bv. Vasile Pârvan, No. 2, RO300223, Timisoara
 Phone: (+40) 256 403420
 E-mail: adrian.pana@upt.ro
 Web: <https://sites.google.com/site/caeredjt/>

NOVEL TECHNIQUE TO ENHANCE THE SECURING LEVEL OF SECURITY PAPER USING THE SUPERPARAMAGNETIC FINGERPRINT OF MAGNETIC NANOPARTICLE DISPERSIONS - NANOMAGSECURITY PAPER

Goal of the project

The continuous diversification of the paper securing techniques is one of the most important ways to erect fences against forgery attempts. The project aims to expand the diversity of high tech means for paper securing. The general objective of the project is to elaborate a new paper securing technique based on the superparamagnetic fingerprint of magnetic nanoparticles made of oxide compounds

Short description of the project

The objective is to elaborate a new paper securing technique based on the superparamagnetic fingerprint of the magnetic nanoparticles.

Project implemented by

- Romanian Academy – Timisoara Branch (Project Coordinator)
- SC CEPROHART SA (Partner 1)
- SC ROSEAL SA Odorheiu Secuiesc (Partner 2)
- SC Datronic – NCIP SRL (Partner 3)
- National Institute of R&D for Izotopic and Molecular Technologies Cluj-Napoca (Partner 4)
- Politehnica University of Timisoara (Partner 5).

Implementation period

July 1, 2014 – September 30, 2017

Main activities

- elaboration of superparamagnetic paper assortments with
 - low security level, using poly-disperse magnetic nanoparticles
 - high security level, using bi-disperse magnetic nanoparticles
 - white color, using core-shell (core/magnetic, shell/polymer) particles
- elaboration and testing the authentication method by static and dynamic magnetometry

Results

- methods for synthesis and characterization of oxide magnetic nanocomposites
- methods for elaboration and validation of magnetic loaded papers
- first instance validation of magnetic loaded papers

Financed through/by

Executive Unit for Financing Higher Education, Research, Development and Innovation (UEFISCDI)

Applicability and transferability of the results

The new method of securing paper using the superparamagnetic nanoparticles can be transferred to SC Ceprohart SA Braila. The transfer will contribute to:

- diversification of the product made in the national paper industry with simple brown paper secure and secure complex white paper,
- orientation of national industry to obtain a special paper grade with high complexity,
- increase the security level of specialty papers, difficult to fake on the internal market
- reduce the imports of security paper
- increase output and thus sales of security paper from Ceprohart.

Research centre

Research Centre for Engineering of Systems with Complex Fluids – Laboratory of Rheology and Magnetometry, from Politehnica University of Timisoara.

URL: <http://mh.mec.upt.ro/ccisfc/>

Research team

Dr. Oana MARINICA

Dr. Aurel ERCUTA

Dr. Catalin MARIN

Techn. Florica BĂLĂNEAN

Techn. George GIULA

Contact information

Dr. Vlad SOCOLIUC – Project Director

Romanian Academy – Timisoara Branch, Center for Fundamental and Advanced Technical Research, Laboratory of Magnetic Fluids

Bd. Mihai Viteazu No. 24, 300223, Timisoara, Jud. Timis

Tel./Fax: (+40) 256 403700

E-mail: vsocoliuc@gmail.com

Dr. Oana MARINICA – Project Responsible from Partner 5

Politehnica University of Timisoara, Research Center for Engineering of Systems with Complex Fluids, Laboratory of Rheology and Magnetometry,

Bd. Mihai Viteazu No. 1, 300223, Timisoara, Jud. Timis

Tel./Fax: (+40) 256 403700

E-mail: oana.marinica@upt.ro; marinica.oana@gmail.com

Web: <http://vsocoliuc.wordpress.com/projects/nanomagsecurity-paper/>

MAGNETIC NANOFUID ROTATING SEAL SYSTEMS FOR HIGH PERIPHERAL SPEEDS - HISPEED NANO MAG SEAL

Goal of the project

The project technical objective is to achieve at experimental model scale new leakage-free MNF sealing systems for high peripheral speeds (up to $30 - 70 \text{ m}\cdot\text{s}^{-1}$) in the sealing area, designed to equip gas turbo-compressors.

Short description of the project

The project proposes the development of seals with magnetic nanofluid (MNF), which has significant advantages compared to conventional mechanical seals: hermetic sealing, exceptionally long lasting operation without intervention (5 years), minimal wear (only viscous friction), virtually zero contamination, optimal torque transmission, wide operating range (10^{-8} mbar - 10 bar), relatively simple and cost efficient execution.

Project implemented by

- SC ROSEAL SA Odorheiu Secuiesc (Project coordinator)
- Romanian Academy – Timisoara Branch (Partner 1)
- National Institute of R&D for Izotopic and Molecular Technologies Cluj-Napoca, Politehnica University of Timisoara (Partner 2)
- Politehnica University of Timisoara (Partner 3)
- Romanina Research and Development Institute for Gas Turbines – COMOTI Bucharest (Partner 4)

Implementation period

July 1, 2014 – September 30, 2017

Main activities:

- laboratory and micropilot scale synthesis of magnetic nanofluids with carboxylic stabilizers and magnetizations between 400-1000 G
- conception, design and implementation of new experimental models of sealing systems with magnetic nanofluid for high peripheral speeds
- testing and performance evaluation of new experimental models sealing systems with magnetic nanofluid, designed for high peripheral speeds

Results

- methods for synthesis and characterization of high magnetization nanofluids with carboxylic stabilizers
- experimental models for new sealing systems
- experimental models for sealing systems – innovative version with magnetic nanofluids with carboxylic stabilization

Applicability and transferability of the results

The expected results will facilitate design and low cost industrial scale production of an original sealing system with stable MNF at high temperatures ($160 - 180 \text{ }^\circ\text{C}$), for high peripheral speeds (up to $30 - 70 \text{ m}\cdot\text{s}^{-1}$) in the sealing gap. They have some important advantages compared to conventional mechanical seals: hermetic sealing, high reliability, relatively simple construction, low execution cost. These performances indicate the market towards ROSEAL Co. is heading, namely the gas turbo-compressors in fertilizer and petroleum refining industry.

Financed through/by

Executive Unit for Financing Higher Education, Research, Development and Innovation (UEFISCDI) .

Research centre

Research Centre for Engineering of Systems with Complex Fluids – Laboratory of Rheology and Magnetometry, from Politehnica University of Timisoara.

URL: <http://mh.mec.upt.ro/ccisfc/>

Research team from Politehnica University of Timisoara

Dr. Oana MARINICA
Dr. Floriana D. STOIAN
Dr. Nicolae CRANIC
Dr. Sorin HOLOTESCU
Techn. Florica BALANEAN
Techn. George GIULA

Contact information

Dr. Tunde BORBATH – Project Director
SC ROSEAL SA
Str. Nicolae Balcescu No. 5/A, 535600, Odorheiu Secuiesc, Jud. Harghita
Tel.: (+40) 266 215998; 266 218122; 266 215912; 747 116610
Fax: (+40) 266 215912
E-mail: office@roseal.topnet.ro
Web: www.roseal.eu; roseal.topnet.ro

Dr. Oana MARINICA – Project Responsible from Partner 3
Politehnica University of Timisoara, Research Center for Engineering of Systems with Complex Fluids, Laboratory of Rheology and Magnetometry
Bd. Mihai Viteazu No. 1, 300223, Timisoara, Jud. Timis
Tel./Fax: (+40) 256 403700
E-mail: oana.marinica@upt.ro; marinica.oana@gmail.com
Web: <http://www.roseal.eu/HiSpeedNanoMagSeal/>

VALORIZATION OF ENERGETIC POTENTIAL FOR AGRO-INDUSTRIAL RESIDUES THROUGH BIODEGRADATION PROCESSES AND CATALYTIC COMBUSTION OF OBTAINED BIOGAS

Goal of the project

The main purpose of the project involves a novel contribution in a direction which is currently under development at national level by providing relevant information impacting the quality of life by increasing regional and local autonomy in the context of valorization the renewable energy resources. The degree of novelty for the project also involves developing an experimental pilot for testing liquid substrates in anaerobic fermentation processes, which can have further industrial applications.

Short description of the project

The proposed project highlights the way different biodegradable materials can be used for biogas production

Project implemented by

Pilot installation and small scale test rigs, used for testing different materials in terms of their potential relative to obtaining biogas, measuring equipment and IT equipment for mathematical / modelling approach.

Implementation period

01.10.2015 – 30.09.2017

Main activities:

Determining the preliminary materials which will be used inside the anaerobic fermentation processes, Laboratory analysis for determining the characteristics of the chosen materials, Using third party infrastructure for comparative and complementary laboratory determinations, Identifying the mathematical models which are to be used inside determinations, Creation and computation of different scenarios for obtaining preliminary data for chosen mathematical models, Preparing and testing inside the reactors of 1l, 2l, 6l, Optimization of pilot installation and tests, Laboratory determinations on resulting materials, Catalysts obtaining and laboratory testing, Comparison of experimental and modeling data, Results dissemination.

Results

Publication of at least 2 papers in ISI journals, publication of at least 2 papers in BDI indexed journals, attendance to a minimum of 2 national or international conferences, publication of a book chapter or book with the obtained results.

Applicability and transferability of the results

The results obtained in the project can be further tested at larger scale in terms of material recipe / biogas quality and quantity and also the development of the pilot installation can be used as an example of combining fossil and renewable sources of energy in order to produce biofuels with impact at local level relative to obtaining of a certain degree of energetic autonomy.

Financed through/by

This project was supported by a grant of the Romanian National Authority for Scientific Research and Innovation, CNCS – UEFISCDI

Research Centre

ICER

Research team

Adrian Eugen Cioablă,
Gavrilă Trif-Tordai,
Dorin Lelea,
Alina Gabriela Dumitrel,
Francisc Popescu,
Vodă Raluca,
Lucia Ana Varga,
Roxana Milotin,
Adrian Țenchea.

Contact information

As. Adrian Eugen Cioablă, PhD
Mechanical Engineering Faculty/Department MMUT,
Address: Mihai Viteazu Blv., No 1, Postal Code 300222, Timișoara
Phone: (+40) 256 403746
Mobile: (+40) 728123289
E-mail: adrian.cioahbla@upt.ro
Web: www.biogaztm.weebly.com

International Research Projects

PROJECTS SUPPORTED BY INTERNATIONAL PUBLIC FUNDS IMPLEMENTED BY PUT 2016

Field	Total number of projects	Number of projects presented
Environment	8	-
Space exploration and exploitation	3	3
Transport, telecommunication and other infrastructure	7	-
Energy	2	1
Industrial production and technology	7	4
Social and political systems, structures and processes	1	-
Total	28	8

EVOLUTION OF PROJECTS SUPPORTED BY INTERNATIONAL PUBLIC FUNDS IMPLEMENTED BY PUT 2012 - 2016

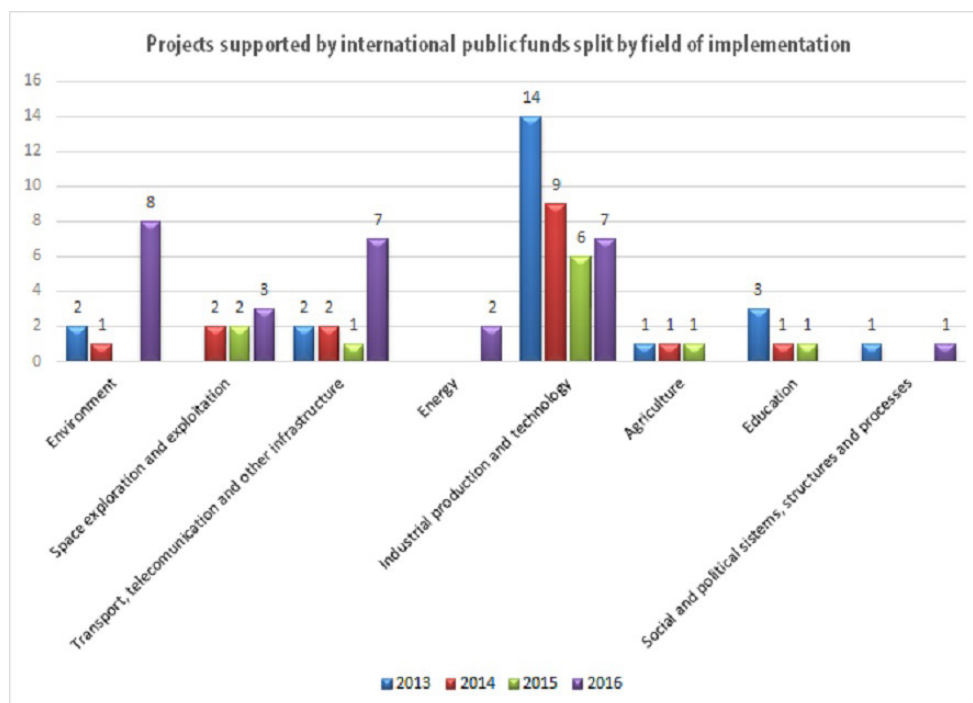
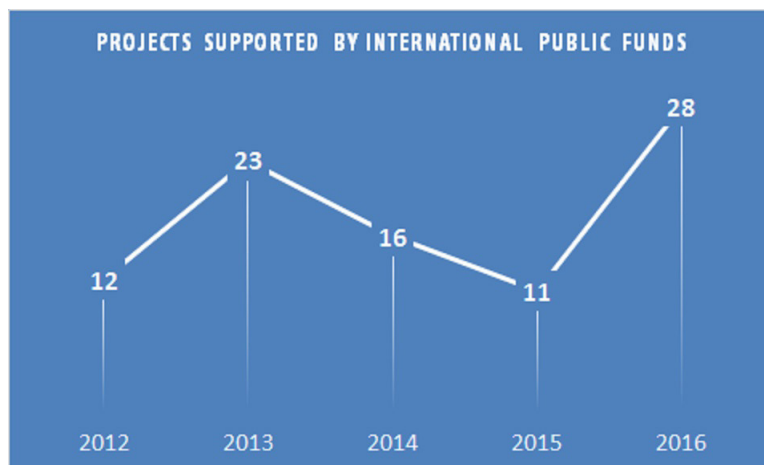

PARTNERSHIP FOR PROMOTING GREEN ENERGY IN THE RURAL AREA OF THE ROMANIAN-SERBIAN CROSS-BORDER REGION – GEROS

Goal of the project

- Increase the level of awareness and information regarding the use of green energy in rural areas by know-how transfer in the cross-border area
- Creation of a group of opinion leaders having know-how in the green energy domain
- Improvement of the infrastructure for insuring better cooperation and knowledge transfer regarding green energy in the cross-border area
- Supporting better preparation for people to develop new activities and to find new jobs in the green energy domain in the cross border-area
- Promoting the importance of using green energy sources for a sustainable development among the population in the cross-border area.

Short description of the project

Project supposed cooperation with Research Institute for Renewable Energies, for realize infrastructure connected and activities for training researches by cooperating with partners from Romania and abroad. The main base of the project consisted in use of experience and competence of Polytechnic University of Timisoara accumulated in the last forty years.

Acting according with the European and both Romanian and Serbian strategies for sustainable development, the project focused on transferring the knowledge and good practice from Romanian institutions that have expertise in the green energy field to the cross-border rural area.

The project addressed two key issues of rural development: the lack of information regarding the use or renewable energy and the high rate of unemployment.

More than that, the joint implementation and the large number of activities that were done in cooperation had a high impact on the connectedness, cultural and social aspects of the cross-border interactions.



Project implemented by

1. UNIVERSITATEA POLITEHNICA DIN TIMISOARA (UPT), Romania, Lead Partner
2. ZITISTE MUNICIPALITY, Republic of Serbia, Partner 1
3. FUNDATIA PENTRU CULTURA SI INVATAMANT "IOAN SLAVICI", Romania, Partner 2

Implementation period

06.10.2015 – 05.10.2016

Main activities

- Launching and Closing Seminar's in RO and RS, for clearly present the goal, objectives and the project expected results, for actors of the rural areas (local authorities, SME's, NGO's, community representatives);
- Creation of the virtual network, with three components that are consistent with three different purposes: the project website, the web platform, and the green energy portal;
- Creation of Green Energy Promotion and Counseling Center at Žitište Municipality, Srednje Banatski County, with a capacity of 30 people, equipped adequately to host different activities;
- Organizing of two trainings, in Žitište, Srednje Banatski County and Timișoara, for preparing Stakeholders in the frame of green energy;
- Organizing cross-border caravan, for 3 days, which followed the route Timisoara, Jimbolia, Kikinda, Zrenjanin, Vrsac and Resita;
- Organizing a School Project contest between schools from the rural areas from both countries in the frame of green energy;
- Publishing a detailed study on the potential sources of renewable energy in the Romanian and Serbian border region.



Results

- 44 stakeholder trained, in green energy applications
- 287 pupils informed about green energy, which was informed by the cross-border caravan, in Timisoara, Jimbolia, Kikinda, Zrenjanin, Vrsac and Resita
- 16 school projects about using of green energy, presented in competition
- 1 green energy cross-border virtual network
- 1 Green Energy Promotion and Counseling Center
- 190 actors of the rural areas (local authorities, SME's, NGO's, community representatives) informed about project.



Applicability and transferability of the results:

- Best practices created will be applied also to future generations;
- The studies and materials created for the project will be used and improved for future years;
- The structures created will contribute to the development of future projects.

Financed through/by

Romania - Republic of Serbia IPA Cross-border Cooperation Programme,
Project number: MIS ETC CODE: 1414



Research team

Dumitru TUCU
Dinu GUBENCU
Nicolae LONTIS
Marinela BALUT
Gabriel MĂLAIMARE
Francisc POPESCU
Dumitru MNERIE

Contact information

Prof. Dumitru TUCU, PhD, ing.&ec.
Faculty of Mechanical Engineering
Department for Mechanical Machines, Equipment and Transportation
Bd. Mihai Viteazul, No.1, RO300222, Timisoara
Phone: (+40) 256 403 601; Mobile: (+40) 744 264 650;
E-mail: dumitru.tucu@upt.ro, geros1414@gmail.com
Web: www.geros.eu

POLE OF COLLABORATION IN NEW FUNCTIONAL ALLOYS - POCAL

Goal of the project

To develop a cross-border network for R&D in New Functional Materials Engineering, adapted to the specific areas of interest (metallurgy) and novel developments (functional, multifunctional and intelligent materials as well as micro and nanoengineering) in the field

Via:

- transfer of knowledge for the beneficiaries looking for continuous education (from their existing aptitudes in metallurgy into novel materials fabrication),
- a base for research and training for students and researchers
- information and connections through collaboration, for beneficiaries looking to develop independent activities in the field of Advanced Materials and Micro/Nanoengineering.

Short description of the project

- Creation of POCAL Cross-Border Network
- Development of interconnected innovation clusters
- Joint research in Advanced Functional Materials
- Design of the transfer of knowledge mechanisms
- Promotion activities
- Development
- Preparation for self-support

Project implemented by

- Politehnica University Timisoara, Romania
- Mining and Metallurgy Institute Bor, Republic of Serbia

Implementation period

23.09.2016 - 22.09.2017

Main activities

1. Design & implementation of POCAL mechanisms
2. Media campaign and POCAL web portal
3. Focusing meeting
4. Study of regional needs and opportunities
5. Updating the fabrication and functional exploration laboratory
6. Publication in special issue of Journal "Copper"
7. Equipment acquisition for microstructural investigations
8. Materials development and optimization
9. Materials characterization
10. Demonstrator
11. Common activities to publish scientific papers
12. Participation in scientific international events
13. POCAL ToK Center
14. Open day
15. Workshop
16. Joint applications
17. Preparation for self-support

Results

High vacuum microfabrication unit



Spark plasma sintering unit



X-ray diffraction unit



Acquisition of new equipment

Development of new materials and technologies

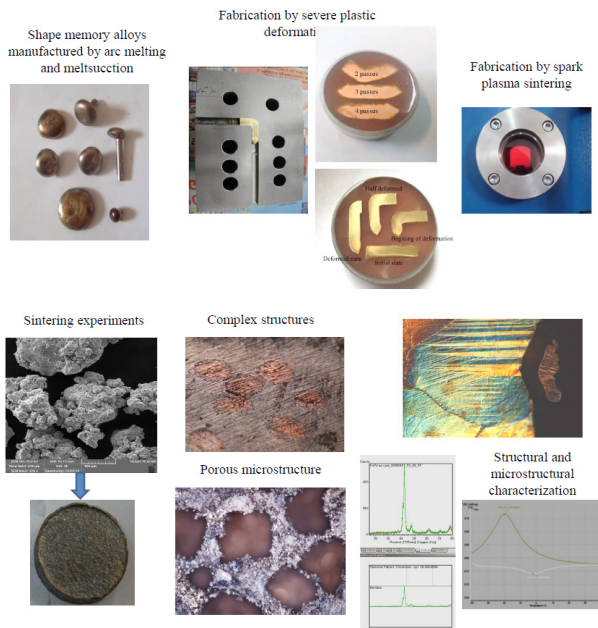

Patent application: Shape memory controlled diaphragm

Cross-border collaboration: workshop, open day



Applicability and transferability of the results:

Development of the capacity of the partners to develop coordinated research in the field of advanced materials micro and nanoengineering, including via collaboration with industrial partners.

Research Centre

POCAL Transfer of Knowledge Center

Financed through/by

Romania – Republic of Serbia IPA Cross-border Cooperation Programme.

Research team

UPT Team

Joint project manager: Prof. Corneliu M. Craciunescu

Joint financial manager: Ms. Adriana Szakallas/ Monica Bota

Joint marketing manager: Dr. Ing. Iosif Hulka

Researcher 1: Prof. Ion Mitelea

Researcher 2: Prof. Victor Budau

Researcher 3: Assoc. Prof. Dragos Utu

Researcher 4: MSc. Ing. Lazar Soveja

IRMB Team

Joint Scientific Advisor: Dr. Ana Kostov

Joint research coordinator: Dr. Aleksandra Milosavljevic

Researcher 1: Dr. Radisa Todorovici

Researcher 2: Dr. Zdenka Stanojevic Simsic

Researcher 3: Dr. Mile Bugarin

Researcher 4: Dr. Milenko Ljubojev

Researcher 5: Dr. Borivoje Stojadinovic

Researcher 6: Dr. Sladan Milenovic

Internal audit coordinator: Vesna Floric

Contact information

Prof. Corneliu Marius CRACIUNESCU, PhD, Ing. Habil.

Faculty of Mechanical Engineering /

Department of Materials and manufacturing Engineering;

Address: Bd. Mihai Viteazul, No. 1, 300022, Timișoara

Phone: (+40) 256 403655

Mobile: not supplied by university, therefore not public

E-mail: corneliu.craciunescu@upt.ro

Web: www.upt.ro/img/files/2015-2016/cercetare/ppr/POCAL_

Web_page_2015.pdf

EUROPEAN PRE-QUALIFIED STEEL JOINTS (EQUALJOINTS)

Goal of the project

The goal of the project is to introduce in the European practice a qualification procedure for the design of moment resisting connection in seismic resistant steel frames, in compliance with EC8 requirements.

Particular objectives of the project are to qualify a set of standard all-steel beam-to-column joints, develop pre-qualification charts and design tools that can be easily used by designers. The project is also intended as a pre-normative research aimed at proposing relevant design criteria to be included in the next version of EC8. Besides it would contribute to the advancement of knowledge in the field of seismic behavior of steel moment resisting joints usually adopted in moment resisting frames (MR), in un-braced bays of dual moment-resisting/concentrically braced frames (MR+CB) and in moment-resisting/eccentrically-braced frames (MR+EB).

Short description of the project

The project is the first attempt in Europe to produce qualification tools for seismic-resistant joints. Novel design methodologies and details for beam-to-column connections that are reliable, feasible and economical, solving also the open issue of design by testing required by EC8 for partial strength/stiffness connections will be provided. The cyclic behavior of beam-to-column joints has a crucial role on the overall seismic response of both MR and dual frames. Recent studies highlighted the influence of joint rotation capacity on the seismic response of mid-rise MR frames designed according to EC8.

The innovative content of the project is represented by:

- Experimental investigations on 96 beam-to-column joint specimens covering: three typical European typologies and one US dog-bone joint typology made of heavy cross sections;
- Evaluation of the influence of different parameters (e.g. axial force, loading protocol and member sizes) on the joint performance;
- Development of codified pre-qualification charts of typical beam-to-column joints used in EU practice.

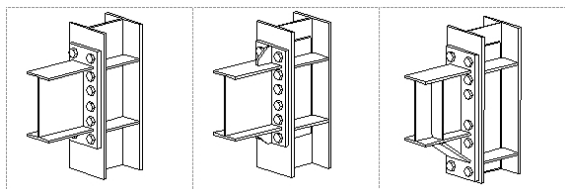

In Europe these tools do not exist in design codes. Hence, this project was intended as pre-normative research aiming to propose design guidelines for the future version of EC8.

Project implemented by

University of Naples "Federico II", Department of Structures for Engineering and Architecture.

Implementation period

01.07.2013 – 31.06.2016

Main activities

Regarding the aim and objectives of the project, extensive experimental and numerical (FE) investigations were carried out with the purpose of evaluating the designed beam-to-column joint assemblies, and the influence of several parameters. The monotonic and cyclic response of 24 beam-to-column joints was evaluated. The numerical simulations comprised the calibration of joint models based on test results, and extension of the experimental program with a parametrical study.

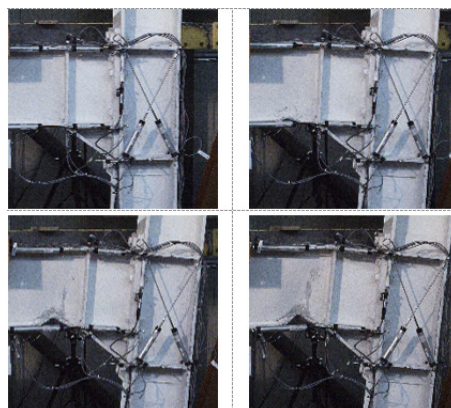
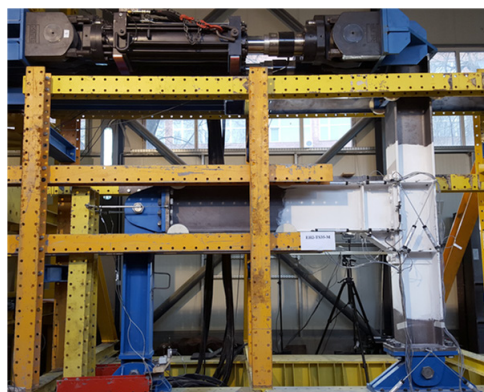

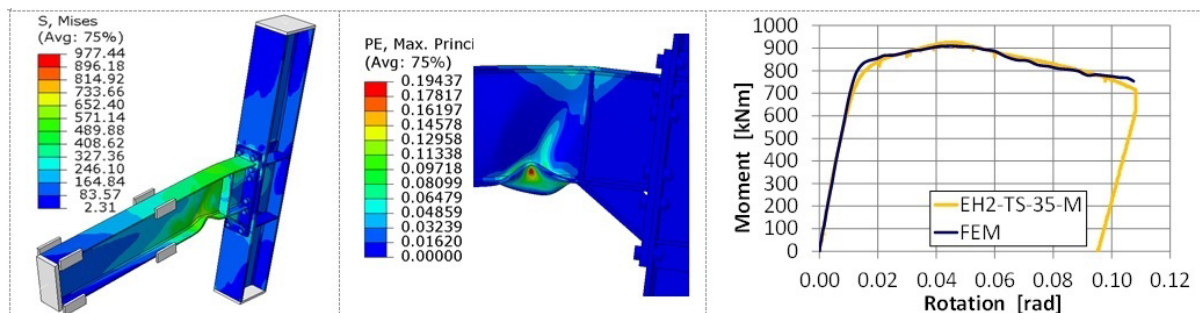

Results

Particular results are represented by the experimental pre-qualification of bolted beam-to-column haunched connections. The numerical calibration of joint models allowed for a better understanding of the load transfer mechanism. The parametric study allowed investigating the influence of: member size, haunch geometry, web panel strength, and cyclic loading. Based on the experimental and numerical investigations, the design procedure was validated.

Applicability and transferability of the results

The project provides easy-to-use design tools for engineers and promotes saving cost solutions. Particular outcomes of the project are intended to be introduced within the new version of European seismic design code EN 1998-1. In addition, the outcomes of the project will be largely beneficial for the EU industry. Because the US joints examined within EQUALJOINTS will be made of heavy sections, which are produced only in Europe, this will be an important opportunity to get on the US Market, consolidating the gain of EU economy and having beneficial impact to exportation of EU products. The impact and transferability of the project is by no means restricted to the selected joint configurations and this project will open the door for other joints to be included in future updates of the guidelines.

Financed through/by

Research Fund for Coal and Steel, grant agreement RFSR-CT-2013 – 00021.

Research Centre

The Research Centre for Mechanics of Materials and Structural Safety – CEMSIG, Politehnica University of Timisoara.

Research Team

- University of Naples “Federico II” (UNINA) (coordinator of the project)
- Imperial College (IC)
- University of Coimbra (UC)
- University of Liege (ULg)
- Politehnica University of Timisoara (UPT)
- European Convention for Constructional Steelwork (ECCS)
- ArcelorMittal Belval & Differdange S.A. (AM)
- CORDIOLI & C

Contact information

Prof.dr.ing Dr.H.C. Dan Dubină
 Member of Romanian Academy
 Department of Steel Structures and Structural Mechanics
 Faculty of Civil Engineering
 Politehnica University of Timisoara
 e-mail: dan.dubina@upt.ro
 tel: 0256 403 920

VALORIZATION OF INNOVATIVE ANTI-SEISMIC DEVICES (INNOSEIS)

Goal of the project

As a result of three RFCS-, one EU- and two nationally funded research projects, 12 innovative replaceable steel-based devices have been developed that improve the response of structures during earthquakes by enhancing their energy dissipation capacity. This project aims at transferring the relevant knowledge from research to practice by the production of several documents and the organization of seminars and workshops.

Short description of the project

UPT is responsible for valorization of removable bolted links and replaceable shear panels concepts.

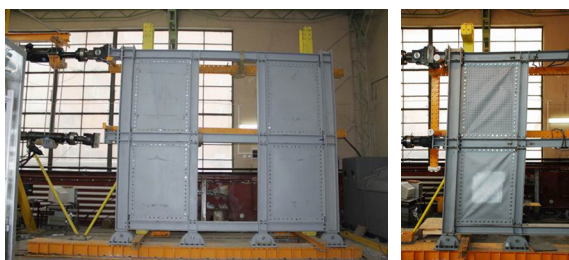
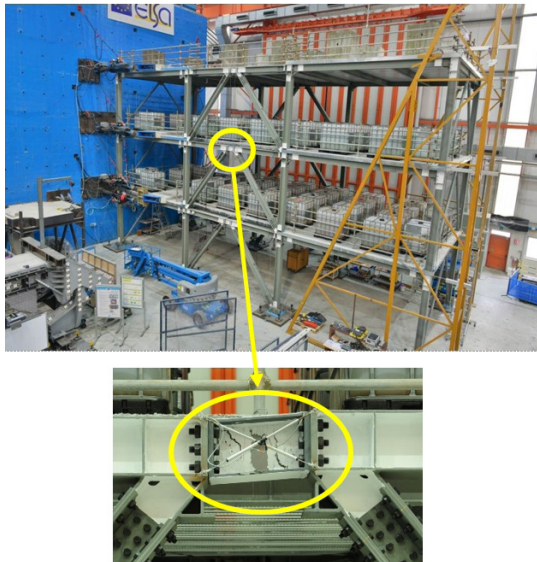

Project implemented by

NATIONAL TECHNICAL UNIVERSITY OF ATHENS – NTUA, Institute of Steel Structures

Implementation period

01.07.2016 – 31.12.2017

Main activities

The work to be carried out will be subdivided in 6 work packages.

- WP 1 will collect and critically review all material available for the anticipated devices. Information brochures will be produced separately for each innovative device and then put together to form a single volume.
- WP 2 will produce a document that defines a methodology for reliably quantifying values of the behavior factors q for use in seismic design.
- WP 3 will clarify which devices must be qualified in accordance with EN 15129 for anti-seismic devices.
- WP 4 will deal with detailed case studies of buildings in which the innovative devices are employed.
- WP 5 is devoted to seminars, workshops and other dissemination actions.
- WP 6 is the work package for management of the project.

Results

4 stories buildings, in which replaceable bolted links and replaceable shear panels are employed, were designed (spectral analysis) by UPT, in two different design cases: moderate seismicity case ($a_g=0.15g$) considering Medium Ductility Class and high seismicity case ($a_g=0.30g$) considering High Ductility Class.

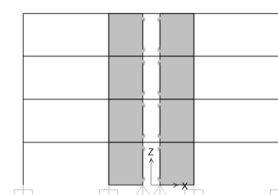
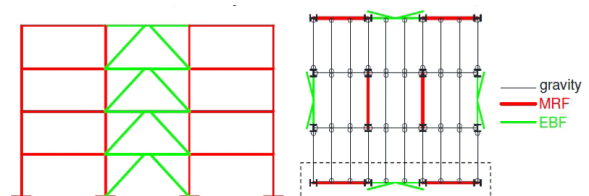

Additional to Eurocode current design, the structures were conceived as dual structures with re-centering capacity. The EBF building has very short removable links with connection kept elastic. The SPSW has two thin steel plates and stanchions as vertical boundary element in the interior span.

In order to verify the re-centering capability and to assess the seismic performance and feasibility of these structures, static nonlinear (pushover) analyses were performed.

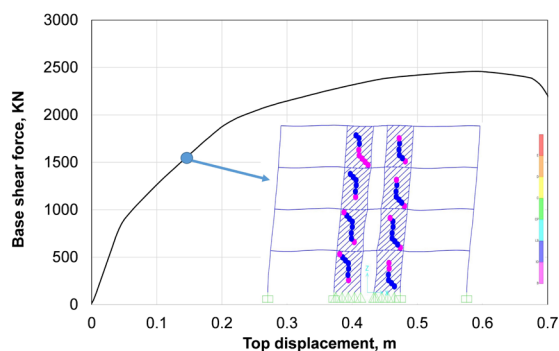
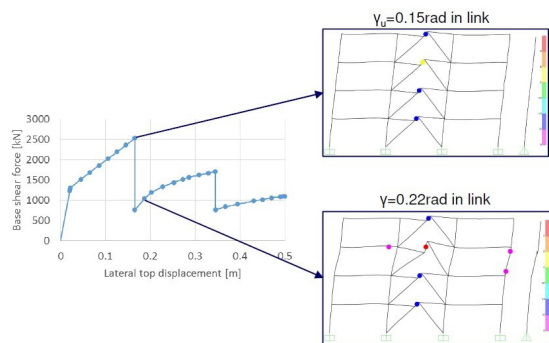

Financed through/by

Research Fund for Coal and Steel, grant agreement RFCS-02-2015 number 709434

Applicability and transferability of the results

- Promotion of innovation in the design of buildings in seismic areas
- Enhancement of structural safety against the governing natural hazard in large parts of Europe.
- Improvement in life cycle costs and sustainability due to the reduction of seismic losses.
- Contribution to the increase in market share for steel, especially in areas of moderate to high seismicity where steel is underrepresented.
- Provision of more alternatives for architectural and structural design of new and existing buildings by increasing the number of code-approved structural systems for steel and composite structures.

Research Centre

The Research Centre for Mechanics of Materials and Structural Safety – CEMSIG, Politehnica University of Timisoara.

Research Team

- UNIVERSITATEA POLITEHNICA TIMISOARA (UPT)
- POLITECNICO DI MILANO (POLIMI)
- UNIVERSITA DEGLI STUDI DI NAPOLI FEDERICO II. (UNINA)
- UNIVERSITA DI PISA (UNIFI)
- RHEINISCH-WESTFAELISCHE TECHNISCHE HOCHSCHULE AACHEN (RWTH)
- ISTITUTO SUPERIOR TECNICO (IST)
- UNIVERSITET PO ARCHITEKTURA STROITELSTVO I GEODEZIJA (UACEG)
- UNIVERSITEIT HASSELT (UHasselt)
- MAURER SOHNE ENGINEERING GmbH & CO KG (MSE)
- CONVENTION EUROPEENNE DE LA CONSTRUCTION METALLIQUE ASBL (ECCS)

Contact information

Prof.dr.ing Dr.H.C. Dan Dubină – Member of Romanian Academy
 Faculty of Civil Engineering
 Department of Steel Structures and Structural Mechanics
 Ioan Curea Street No.1, 300224, Timișoara
 Phone: +40 (0) 256 403 911
 Mobile: +40 (0) 740 137 610
 E-mail: dan.dubina@upt.ro

VALORISATION OF KNOWLEDGE FOR SUSTAINABLE STEEL-COMPOSITE BRIDGES IN BUILT ENVIRONMENT - SBRIPLUS

Goal of the project

Within the RFCS project SBRI, a holistic approach to assess steel-composite bridges by combining Life Cycle Assessment (LCA), Life Cycle Costs (LCC) and Life Cycle Performance (LCP) was developed and applied to some representative bridges. This project aims at the valorisation, dissemination and extension of the developed method for advanced applications and further bridge types. To reach a wide audience among engineers and authorities, two Design Manuals and a software tool will be disseminated in the frame of several seminars across Europe.

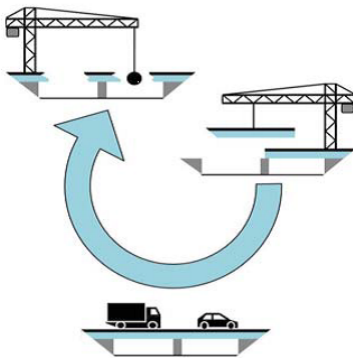

Sketch of the life-cycle of a bridge

Short description of the project

The aim of SBRIplus project is to promote the developed knowledge and design methodologies by combining the LCA, LCC and LCP analyses along the entire life-cycle of bridges.

Project implemented by

ArcelorMittal Belval & Differdange S.A., Luxembourg

Implementation period

01.07.2016 – 31.06.2018

Main activities

1. Explanation of methodology and background by elaboration of worked examples and improvement of the SBRI-tool;
2. Extension of bridge types by advanced application to innovative bridges across Europe demonstrating the flexibility and applicability of the methods developed;
3. Dissemination activities (11 European languages, organization of 13 workshops);
4. Providing of recommendations for advanced applications and guidelines for bridge authorities;
5. To provide recommendations summing up and concluding the analyses and being the bases for guidelines to be elaborated for bridge authorities.

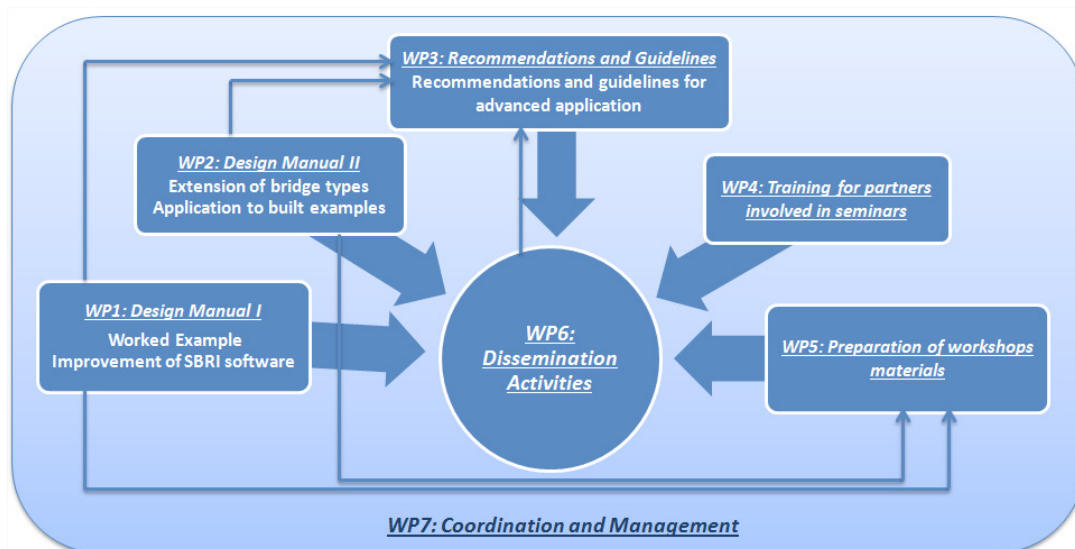

The 7 Work Packages (WPs) of the SBRIplus project

Results

Two design manuals will be prepared and translated in 11 European languages and distributed within the planned dissemination activities. The first Design Manual includes background information on the methodology and worked examples for easy application with the help of the improved software tool. By analyses of built examples, the SBRI method will be applied to innovative bridge solutions, the results and the conclusions being shown in the second Design Manual.

The seminars around Europe will offer the opportunity to present not only the results of the SBRIplus project, but also the advanced application to innovative solutions in addition to national regulations and practice.



The location of the seminars around Europe

Applicability and transferability of the results

As bridges are an integral part of the European-wide traffic infrastructure, being of vital importance for society, the amount of steel used in the construction of steel and steel-composite bridges represents an important market for the steel industry. The application of a sustainable life cycle design of bridges causes an increased steel consumption. As currently the decisive criteria at tender stage are the minimum construction costs, the needed and promoted shift to a sustainable life cycle decision making, brings the steel-composite bridges forward. The advantages of low environmental inputs, low life cycle costs and low user costs for the entire life cycle are combined in sustainable steel-composite structures. The major objective of the proposal is to valorize and transfer the knowledge gained in the SBRIplus project into practice and thus to make it available to a broad audience along engineers, authorities, bridge operators and designers.

Financed through/by

Research Fund for Coal and Steel

Total budget of "SBRIplus" project (grant agreement No 710068): 675.047 €

Budget of the Politehnica University of Timisoara: 41.983 €

Research Centre

Research Center for Mechanics of Materials and Structural Safety (CEMSIG), Politehnica University of Timisoara

Research Institute for Renewable Energy (ICER-TM), Politehnica University of Timisoara

Research Team

ArcelorMittal Belval & Differdange SA (Luxembourg);

University of Stuttgart (Germany);

University of Coimbra (Portugal);

Aktien-Gesellschaft der Dillinger Hüttenwerke AG (Germany);

Institut Francais des Sciences et Technologies des Transports, de l'Amenagement et des Reseaux (France);

RAMBOLL Sverige AB (Sweden);

BRISA Engenharia e Gestao SA (Portugal);

FOSTA -Forschungsvereinigung Stahlanwendung e.V. (Germany);

Politehnica University of Timisoara (Romania);

Ceske Vysoke Uceni Technike V Praze (Czech Republic);

Fundacion Tecnalia Research & Innovation (Spain);

University of Naples Federico II (Italy);

ATKINS Consultants Limited (UK);

Stichting Bouwen met Staal (Netherlands);

BKE sp. z o.o. (Poland);

Sveuciliste u Zagrebu Gradevinski Fakultet (Croatia);

S. Stathopoulos - K. Farros Consulting Engineers (Greece).

Contact information

Prof. Viorel UNGUREANU, PhD

Faculty of Civil Engineering

Department of Steel Structures and Structural Mechanics

Address: Str. Ioan Curea, No. 1, 300224, Timisoara

Phone: (+40) 256 403912

Mobile: (+40) 740 137640

E-mail: viorel.ungureanu@upt.ro

Web: www.ct.upt.ro

QUALITY OF SERVICES IMPROVEMENT FOR GNSS LOCALISATION IN CONSTRAINED ENVIRONMENT BY IMAGE FUSING TECHNIQUES (IMFUSING)

Goal of the project

The Line of Sight (LoS) of a satellite could be disrupted by obstacles, reducing the accuracy of the information provided to a Global Navigation Satellite System (GNSS) receiver. The first objective of the project is to eliminate or weight the signals coming from these satellites. To simplify the identification of satellites having a direct LoS with the GNSS receiver, this project proposes, as a supplementary sensor, to use a fish eye camera.

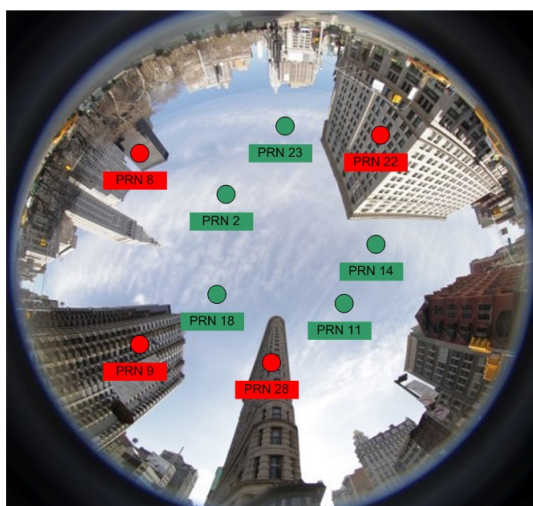

Original image.
The satellites were marked at Thales-Alenia.



Segmentation result
(the non sky region is colored in black)
obtained applying an original segmentation method.

Short description of the project

To provide sufficient information to the GNSS receiver, at the image processing level, the algorithms conceived will include the calibration of the camera sensor, image segmentation techniques, and distance and angle measurements deduced from calibrated image analysis. The algorithms at user sensor level will use camera information to discard measurements, will estimate boundaries of accuracy, will build a Quality of Service (QoS) indicator on the computed position and will authenticate the position. The algorithms at tracking loop level will use camera information to adjust the GNSS receiver correlator.

Project implemented by

- UPT as contractor
- Thales-Alenia Toulouse France as subcontractor

Implementation period

October 1 2014 – March 30 2017

Main activities

Phase I 01/10/2014–31/08/2015: State of the art analysis (already validated),

Phase II September 1 2015 – March 31 2017

- 01/09/2015–30/11/2015: Core technical development (already validated)
- 01/12/2015–31/01/2016: Test campaign (carried out)
- 01/12/2015–31/05/2016: Performance analysis (pending validation)
- 01/06/2016–30/09/2016: Dissemination and exploitation.

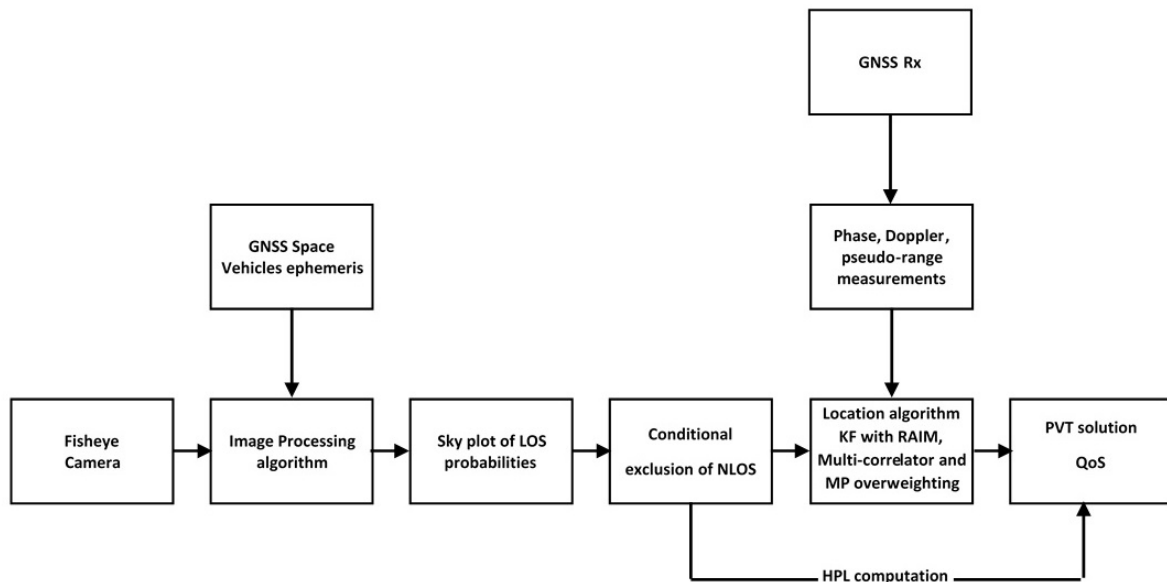

IMFUSING algorithm architecture final solution

Results

Deliverables:

Report on the State of the art in Image-GNSS fusion, Preliminary Design Review Report, Test Review Board Report, MATLAB codes for developed algorithms.

Dissemination:

Scientific paper in a scientific journal, Technical Note on synthesis of the study.

A first dissemination result:

Naforniță C., David C., Isar A., Preliminary results on sky segmentation, Proceedings of 2015 International Symposium Signals Circuits and Systems, 9-10 July 2015, Iasi, Romania, pp. 1-4, 10.1109/ISSCS.2015.7203933, Print ISBN: 978-1-4673-7487-3

Applicability and transferability of the results

The subject was evaluated at the start at technology maturity level 1 (Scientific Research), and it is aimed to conclude the project at technology readiness level (TRL) 3 (Laboratory Experiments).

Financed through/by

European Space Agency (ESA), contract number 10031/02.08.2013
 - UPT: 128.234 EURO,
 - Thales Alenia: 70.000 EURO

Research centre

Intelligent Signal Processing

Research team

Prof. Miranda NAFORNIȚĂ, PhD
 Assoc. Prof. Corina NAFORNIȚĂ, PhD
 Prof. Andrei CĂMPEANU, PhD
 Prof. Ioan NAFORNIȚĂ, PhD
 Prof. Marius OTEȘTEANU, PhD
 Prof. Vasile GUI, PhD
 Prof. Alexandru ISAR, PhD
 Assist. Prof. Ciprian DAVID, PhD

Contact information

Prof. Alexandru ISAR, PhD
 Electronics and Telecommunications Faculty
 Communications Department
 2 Bd. V. Pîrvan, 300223, Timișoara
 Phone: (+40) 256 403307
 Mobile: (+40) 728 009686
 E-mail: alexandru.isar@upt.ro
 Web: <http://www.tc.etc.upt.ro/isprc/>

SY4SCI SYNERGY STUDY: OCEAN VIRTUAL LABORATORY

Goal of the project

The project allows oceanography experts to discover the existence and then to handle jointly, in a convenient, flexible and intuitive way, the various co-located Earth Observed (EO) datasets and related model/in-situ datasets over dedicated regions of interest with a different multi facet point of view. The developed tools shall foster the emergence and prototype of new methods and products making use of the complementarity between sensors to study ocean related processes.

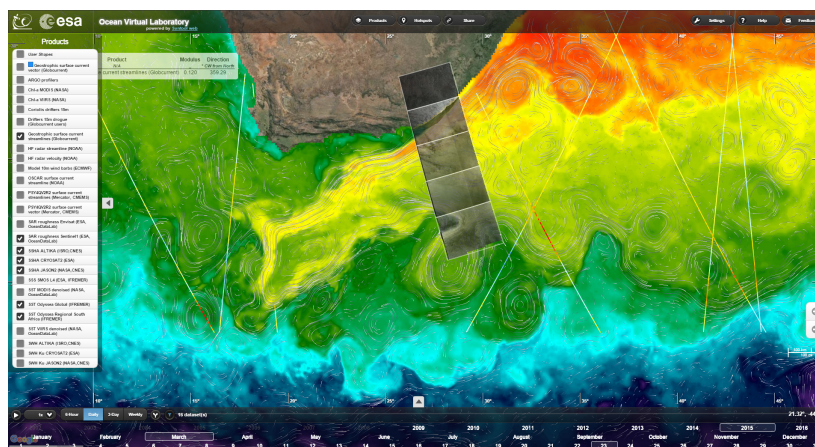

Short description of the project

The project aims to implement new software putting together two types of tools: a mathematical programming environment and a geographical programming environment.

The principal tasks are the following.

- Implementation the SY-4Sci OVL novel synergy algorithms and the OVL platform, perform validation of new synergy products and access Sentinel1 and Sentinel3 products suitability for synergy studies.
- Write recommendation for further scientific research exploiting the synergy between ocean satellite sensors with a special focus on Sentinel1 and Sentinel3.

Implementation period

October, 24, 2014 – October, 27, 2016.

Project implemented by

- OceanDataLab, Brest, France – Contractor
- Institut Francais de Recherche pour l'Exploitation de la MER (IFREMER), Brest, France – Subcontractor
- Nansen Environmental and Remote Sensing Center (NERSC), Bergen, Norway – Subcontractor
- Politehnica University of Timisoara (UPT), Romania – Subcontractor
- Institute of Oceanology of the Polish Academy of Sciences (IO PAN), Sopot, Poland – Subcontractor
- Plymouth Marine Laboratory (PML), Plymouth, UK – Subcontractor

Main activities

- Review of existing synergy methods and consolidation of requirements
- Define new methods and algorithms
- Selection and preparation of EO products database
- Specification and implementation of the prototype platform and processing modules
- Validation of the developed tools and products
- Recommendations for further scientific research.

Results

Deliverables

- Requirements Baseline,
- Algorithm Theoretical Basis document,
- Product Specification document,
- Product Validation Report,
- Software User Manual.

Dissemination

- Publications,
- Presentations,
- Training Courses.



Applicability and transferability of the results

The subject is evaluated today at technology maturity level 1 and it is aimed to conclude the project at technology readiness level 3.

Financed through/by

- European Space Agency (ESA), ESRI/Contract N° 4000112389/14/I-NB – consortium 250000 EURO,
- UPT: 24713 EURO.

Research centre

Research Centre for Intelligent Signal Processing (ISPRC)

Research team

Prof. Dr. Eng. Alexandru Isar
Assoc.Prof. Dr. Eng. Corina Nafoarnita

Contact information

Prof. Alexandru ISAR, PhD
Electronics and Telecommunications Faculty
Communications Department
Address: Bd. Vasile Pârvan, No. 2, 300223, Timișoara
Phone: (+40) 256 403307
E-mail: alexandru.isar@upt.ro
Web: <http://www.tc.etc.upt.ro/isprc/>

STUDY FOR A MONITORING STATION FOR EGNOS TO SUPPORT SERVICES IN EASTERN EUROPE

Goal of the project

The objective of the study is the automatic reporting of EGNOS performance over Romania as well as the assessment of corrections transmitted by other SBAS.

Short description of the project

Due to its geographical location, Romania is an ideal candidate for system performance monitoring at the border of EGNOS service area. Receivers placed in most parts of Romania will be able to track, in addition to EGNOS, also the Russian Federation's System for Differential Corrections and Monitoring (SDCM) and India's GPS Aided GEO Augmented Navigation system (GAGAN).

The Contractor will implement within ESA regulatory framework and based on ECSS standards, all activities related to: an automatic reporting of EGNOS performance over Romania and Assessment of other SBAS visible from Romania.

The Contractor is requested to deploy a monitoring site network for the EGNOS service and all GNSS systems within Romania and Archive data for remote access by the Agency.

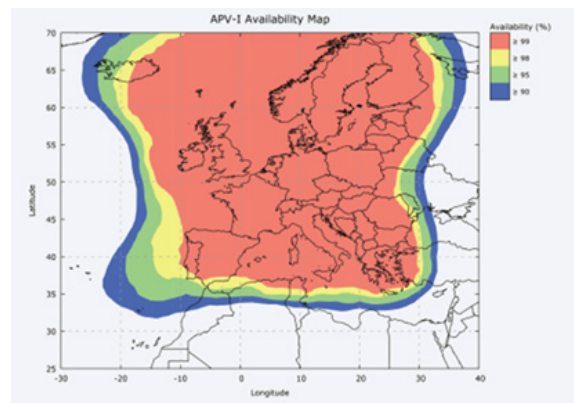

EGNOS Service Area according to ESNP Service Definition Document v3.0

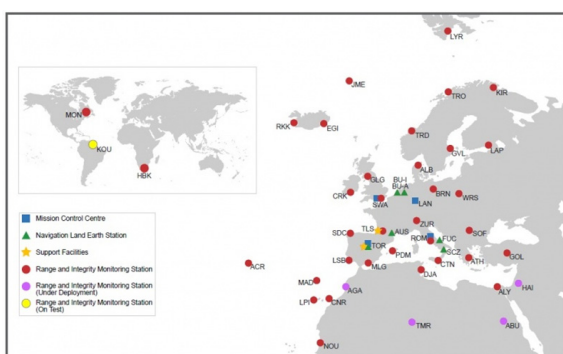

EGNOS RIMS Sites

Implementation period

Sep 19 2016 – Sep 19 2017

Project implemented by

- Politehnica University of Timisoara (UPT) – Contractor
- Alenia Toulouse France – Subcontractor
- Pildo Labs Spain – Subcontractor

Main activities

- Management
- Site Ranking
- Site Selection
- Deployment
- Automatic Reporting & Performance Comparison
- Communication

Results

Deliverables

- Site Selection Justification Document
- Volume Simulation Plan
- Service Volume Simulation Report
- Hardware Deployment Plan
- Hardware Deployment Report
- Project Management Plan
- Executive Summary Report
- Financial Report
- Final Report
- Contract Closure Summary

Dissemination:

- Scientific paper in a scientific journal
- Technical Note on synthesis of the study

Applicability and transferability of the results

The subject is evaluated today at technology maturity level 1 (Scientific Research), and it is aimed to conclude the project at technology readiness level (TRL) 6 Model demonstrating the critical functions of the element in a relevant environment.

Financed through/by

- European Space Agency (ESA), contract number No. 4000 117 527 / 16/NL/CBi – UPT: 115000 EURO
- Thales Alenia: 15000 EURO
- Pildo Labs: 20000 EURO

Research centre

Research Centre for Intelligent Signal Processing (ISPRC)

Research team

Assoc. Prof. Corina Naforniță (Technical Manager)
Prof. Andrei Câmpeanu (Contracts Officer)
Prof. Alexandru Isar
Prof. Ioan Naforniță
Prof. Marius Oteșteanu;
Prof. Vasile Gui
Lecturer Ciprian David
Eng. Norbert Matanie

Contact information

Assoc. Prof. Corina NAFORNITA, PhD
Electronics and Telecommunications Faculty
Communications Department
2 Bd. V. Pîrvan, 300223, Timișoara
Phone: (+40) 256 403318
Mobile: (+40) 722 782 359
E-mail: corina.nafornita@upt.ro
Web: <http://www.tc.etc.upt.ro/isprc/>

PROJECTS SUPPORTED BY PRIVATE FUNDS

PROJECTS SUPPORTED BY PRIVATE FUNDS IMPLEMENTED BY PUT 2016

Field	Total number of projects	Number of projects presented
Environment	52	4
Transport, telecommunications and other infrastructures	17	3
Energy	2	1
Industrial production and technology	50*	3
Education	17	1
Social and political systems, structures and processes	1	-
Technological and engineering sciences	3	-
Total	142	12

* *National Private Funds*: 47 projects;
International Private Funds: 3 projects.

EVOLUTION OF PROJECTS SUPPORTED BY PRIVATE FUNDS IMPLEMENTED BY PUT 2012 - 2016

A series of inter-institutional collaborations have crucially influenced PUT's ranking classification exercise between 2012 and 2016.

Two main categories of institutional collaborations are to be noted: inter-university collaborations and collaborations with enterprises. Each of them has clearly established, mutually-shared objectives: mutual support, know-how transfer, and cooperation objectives for a common output.

PUT has always maintained a close relationship with the community, with the external environment, this relationship being its own reason to exist. Beyond the actual research and formal education, the research accomplished through technological transfer has been a constant concern for the University departments, faculties and management structures, which is reflected in the number of contracts with private companies.

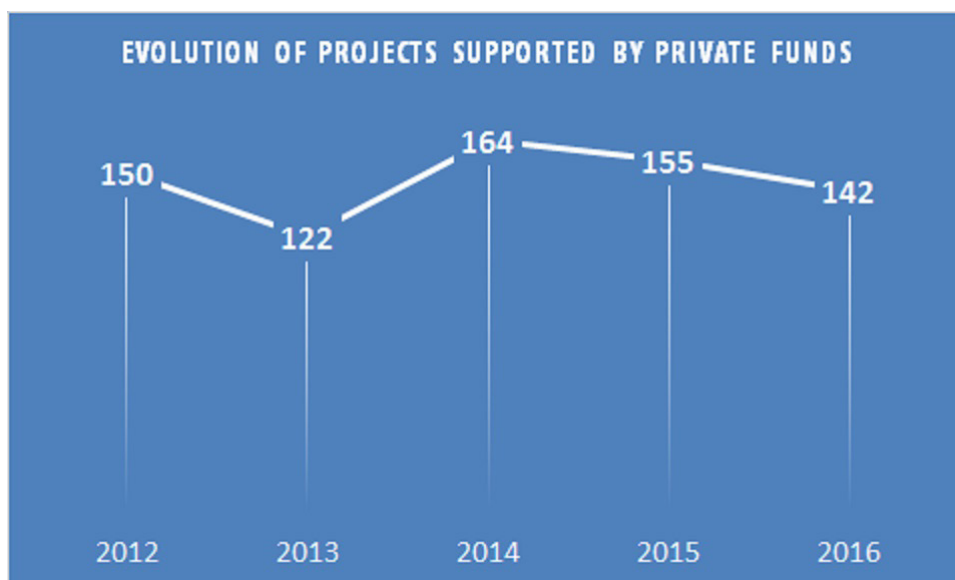

This chapter presents a selection of the research contracts with third parties.

AC_G_XBU_ACADEMY

Goal of the project

The aim of this project is to develop the e-Learning part of the AUTOSAR (AUTomotive Open System ARchitecture) Division in Continental Automotive Romania. The aim of AUTOSAR is to create and further establish different standards for Automotive Electrics and Electronics architectures. Such an infrastructure can assist with the developing of automotive software. The current trend is to adopt AUTOSAR on different functional areas therefore is a tremendous demand of state-of-the-art trainings, available in different R&D locations. Hence the need to offer e-Learning trainings in a reliable and dependable fashion.

Short description of the project

In the rapid developing market of automotive industry, cutting-edge technologies are being introduced. One such example is the AUTOSAR standard. Companies are investing a large amount of finances for the training of their employees into the intricacies of such technologies. In order to face such an increase of the training costs, automotive corporation have started lately switching their approach to e-Learning systems. In order to develop the e-Learning solution we focused on the Software Development part of automotive industry. Therefore we had to gather the ideas from different trainers, come with a common approach and use specific techniques so that the trainee should get a real feeling of the material. It is presented the design, implementation and evaluation of this e-Learning solution, but more than that faced issues and learned lessons. Developing this solution has offered different insights into how to approach such a task which are useful for the further expansion of the project, but also for future researchers who might encounter such a challenge of developing e-Learning solutions for the automotive industry. These are all grouped in a set of guidelines related to following a model of implementation, getting track of participants, user interaction with the AUTOSAR standard, test and production development and so on.

Project implemented by

Razvan Bogdan

Implementation period

July 2015 – March 2016

Main activities

The solution, which is nowadays part of an actual ongoing automotive project, is to transfer the existing materials, knowledge and also software tools in an e-Learning environment. In this way, the AUTOSAR training can be offered at a lower cost, but to a larger community around the world. In order to achieve this task different steps were taken into consideration.

Step 1: Search for different tools that can be used in order to achieve the above goal

Step 2: Defining a process in order to develop the online training material

Step 3: Evaluation of the e-Learning solution

Results

This solution is practically offering to each trainee the means to understand and apply the intricacies of AUTOSAR standard to different projects. Giving the fact that is an e-Learning system, issues such as time and cost were overcome. Participants can be from different locations around the world and the trainer does not have to move long distances for a certain Research & Development center. From the trainee point of view, he / she can spend as much time as needed until lessons are learned and also different quizzes and assessments are available both during the concept presentation and at the end of each module. The architecture of the e-learning solution is presented in the figure.

Also, 2 scientific papers have been published as results of this project. One of the paper, entitled "Guidelines for developing educational environments in the automotive industry", has been accepted for publication in the Web of Science rated journal, called International Journal on Interaction Design and Architectures.

Applicability and transferability of the results

The present project is being used in automotive industry since 2015.

Financed through/by

S.C. Continental Automotive
Romania S.R.L.

Research Centre

Mobile computing, sensor networks
and embedded systems Laboratory

Research team

Razvan Bogdan, Mirela Dragota

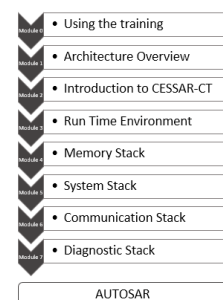

Contact information

Assist. Prof. Razvan BOGDAN, PhD
Department of Computers and Information Technology
Address: V. Parvan Blv., no. 2, 300223, Timisoara
Phone: (+40) 256 403 725
Mobile: +40726651711
E-mail: razvan.bogdan@upt.ro
Web: <http://staff.cs.upt.ro/~rbogdan/>

MICRO-HYDRO POWER PLANTS INTEGRATION IN THE ROMANIAN POWER SYSTEM. CASE STUDY FOR CARAS-SEVERIN AREA

Goal of the project

Power system analysis and optimization for the micro-hydro power plants' integration in the Caras-Severin area of the Romanian Power System (Enel Banat Distribution Operator).

Short description of the project

The renewable energy sources represent an important issue for the Romanian and EU energy policy and sustainable development strategy. The projects refer to micro-hydro power plants integration in the Caras-Severin area of the Romanian Power System (Enel Banat Distribution Operator). The analysis has been performed for the North-Western, Western, Central and South-Western part of the Romanian Power System. Various operating condition, with the consumption forecast for 2020 and 2025, were considered, taking into account all the renewable energy sources (wind, solar, biomass, hydro). The medium voltage network for the interest area has been modelled in detail.

Project implemented by

S.C. Cons Electrificarea Instal S.R.L., Timisoara

Implementation period

2016-2017

Main activities

- power system data base validation;
- Enel Banat distribution network modelling; operating condition computing and analysis;
- power consumption and renewable energy generation forecast;
- power flow computing for various operating condition of the North-Western, Western, Central and South-Western part of the Romanian Power System (peak and unloaded type operating condition for 2016, 2020, 2025 years);
- contingency analysis, in the presence / absence of the renewable energy sources.



Results

- power flow corresponding to 2016 year and forecasted 2020 and 2025 years;
- power flow corresponding to the medium voltage electrical network (Enel Banat Timisoara area);
- voltage value without / with the new generating units;
- quick / slow maximum voltage variation value for critical buses;
- transformer loading without / with the new producers;
- power flow through the power system elements and loading level;
- integration solution validation and system reinforcement recommendations.

Applicability and transferability of the results

Knowledge transfer to other renewable power plants developers and designers, or to the electrical distribution network operators (Enel, CEZ, EON, Electrica in Romania).

Financed through/by

S.C. Cons Electrificarea Instal S.R.L., Timisoara

Research Centre

Power Systems Analysis and Optimization Research Centre

Research team

Stefan KILYENI
Constantin BARBULESCU
Attila SIMO
Annamaria KILYENI

Contact information

Prof. Stefan KILYENI, PhD
Faculty of Electrical and Power Engineering
Power Systems Department:
Bd. V. Parvan, No. 2, 300223, Timisoara
Phone: (+40) 256 403 416
Mobile: (+40) 741 808 18
E-mail: stefan.kilyeni@upt.ro
Web: www.et.upt.ro

THE MONITORING OF WATER QUALITY USED IN DIALYSIS

Goal of the project

The goal of the project is to monitoring the water quality used in dialysis.

Short description of the project

During the project various parameters of dialysis water are periodical analyzed from samples collected by the beneficiary. The parameters analyzed and the times for the samples collections are commonly agreed by the beneficiary and by the execution team. The analysis of the main parameters for the monitoring of water quality used at dialysis are needed to see if they are into the maximum admissible concentration of legislation..

Project implemented by

Faculty of Industrial Chemistry and Environmental Engineering.
Department of Applied Chemistry and Engineering of Inorganic Compounds and Environmental.

Implementation period

January 3, 2016 – January 4, 2017

Main activities

- During the project the metal ions (Al, Pb, Cu) from the dialysis water will be analyzed each month.
- The ions Ca, K, Mg, Na, Al, Cu, Pb, Cr, Sb, As, Ba, Cd, F⁻, Hg, NO₃⁻, Se, Ag, SO₄²⁻, Be, Cl⁻, Tl, Zn from system water, deionized water and permeate will be analyzed in one month.

Results

Monthly are analyzed three samples of water (system water, deionized water and permeate) to determine the concentrations of metal ions.

Applicability and transferability of the results

- Improved university–industry relationships.
- Updating curricula in accordance with the economic realities of the local area.
- The results are consistent with the legislative framework in force. Adoption by the university of new mechanisms and management techniques resulted from the project activities.

Financed through/by

S.C. NEFROMED S.R.L.

Research Centre

Research Center of Environmental Sciences and Engineering

Research team

University Lecturer Ciopec Mihaela, PhD
Associate Professor Negrea Adina, PhD

Contact information

University Lecturer Mihaela Ciopec, PhD
Faculty of Industrial Chemistry and Environmental Engineering
Department of Inorganic and Applied Chemistry and Environmental Engineering, Bv. Vasile Pârvan, No. 6, RO300223, Timisoara
Phone: (+40) 256 404192
Mobile: 0722806880
E-mail: mihaela.ciopec@upt.ro

MONITORING THE QUALITY OF WASTES FROM TECHNOLOGICAL PROCESS

Goal of the project

The goal of the project is to monitoring the quality of waste and sludge from technological process.

Short description of the project

During the project various parameters of wastes and mud are periodical analyzed from samples collected by the beneficiary. The parameters analyzed and the time for the samples collections are commonly agreed by the beneficiary and by the execution team. The analysis of the main parameters for the monitoring the quality of waste are required for their storage according to law.

Project implemented by

Faculty of Industrial Chemistry and Environmental Engineering.
Department of Applied Chemistry and Engineering of Inorganic Compounds and Environmental.

Implementation period

October 3, 2016 until October 2, 2017

Main activities

The main activities of the project are:

- analysis of volatile organic compounds (COV) from solid and liquid waste.
- leaching tests for sludge to be placed in a class of waste.
- analysis of the following parameters: Cr^{3+} , Cu^{2+} , Ni^{2+} , Cd^{2+} , Pb^{2+} , Zn^{2+} , pH and humidity from sludge.
- the main parameter are analyzed once a month in according to the project plan.

Results

1. The volatile organic compounds (VOC) from waste were analyzed.
2. The concentration of heavy metals in sludge from the process was determined.
3. Sludge leaching tests they were made.

Applicability and transferability of the results

- Improved university–industry relationships.
- Updating curricula in accordance with the economic realities of the local area.
- The results are consistent with the legislative framework in force.
- Adoption by the university of new mechanisms and management techniques resulted from the project activities.

Financed through/by

S.C. FLEXTRONICS ROMANIA S.R.L.

Research Centre

Research Center of Environmental Sciences and Engineering

Research team

University Lecturer Ciopec Mihaela, PhD
Associate Professor Negrea Adina, PhD

Contact information

University Lecturer Mihaela Ciopec, PhD
Faculty of Industrial Chemistry and Environmental Engineering,
Department of Inorganic and Applied Chemistry and Environmental
Engineering, Bv. Vasile Pârvan, No. 6, RO300223, Timisoara
Phone: (+40) 256 404192
Mobile: 0722806880
E-mail: mihaela.ciopec@upt.ro

ARCHITECTURAL DESIGN CONTEST “THERMAL REHABILITATION OF CITY BLOCKS IN TIMIȘOARA”

Goal of the project

Large areas of many Romanian cities present usually five or eleven story constructions, organized in closed patterns, offer a very strange image with punctual thermal rehabilitation for a single apartment or a single staircase in a building having 2/3/4 entrances and private owners. The lack of knowledge or experts advice is reflected in the last two decades of facades and roofs rehabilitations.

As a didactic exercise, together with the one of the largest company that produces construction materials for ETICS system (Baumit), during the last two academic years we developed a project for one of the 4th year discipline, Construction Physics in which the students could produce fresh ideas to obtain a unified architectural image.

Short description of the project

Urban and thermal rehabilitation for concrete prefabricated panel blocks – student ideas.

Project implemented by

4th year Architecture students from the optional project Construction Physics

Implementation period

15.04.2016–15.07.2016



Main activities

The whole study had one technical part considering the necessary isolation (with thermal calculation) and the other one, more architectural, was promoted as a competition, with real prizes to stimulate the participants, also having chromatic constraints given by local regulations.

Results

Considering the importance of managing a unified image for these specific collective houses and the idea of finding a concept capable to be reproduced at a large scale, the results show that young specialists can have an interesting perspective over buildings older than their own age. The common interest coming from an “outsider” prevailed the individual concerns.

Applicability and transferability of the results

Faculty and City hall exhibitions, Baumit materials

Financed through/by

BAUMIT ROMANIA COM S.R.L.

Research team

Arch. Catalina BOCAN (from UPT)

Arch. Dragos BOCAN (external associated assistant lecturer of UPT)

Arch. Adrian ALBULET (from Baumit)

Contact information

Catalina BOCAN

Architect, Associate Professor, PhD in Civil Engineering

Head of the Architecture Department, Faculty of Architecture and Urbanism, Politehnica University of Timisoara, Romania

T. Lalescu street, no.2, 300223 Timisoara, Romania

mob. 004 0720 060397, tel. 004 0256 404021, fax 004 0256 404020

E-mail: catalina.bocan@upt.ro

LOAD BEARING CAPACITY ASSESSMENT OF PRESTRESSED CONCRETE COLUMNS USED IN AGRICULTURE

Goal of the project

The behavior of high span and small cross sections prestressed concrete elements are less studied. Scope of the project was to investigate through laboratory tests the behavior of such specimens used in agricultures.

Short description of the project

The load bearing capacity and behavior and of prestressed concrete columns used in agriculture were investigated through laboratory tests. Test methods, static schemes and element position in the tests were established previously together with the beneficiary and were correlated with the available norms and codes. There were tested 18 specimens in 2 different static scheme. The investigated parameters were: behavior of columns in the elastic domain; deformations in elastic phase, just before failure and at failure; load values at cracking, at the initiation of failure and in ultimate state; deflection and crack width at every load step.

Project implemented by

S.C. BAUELEMENTE S.R.L.
Loc. Ariceștii – Rahtivani, jud. Prahova, Str. Strada Bruxelles nr. 877A

Implementation period

05.09.2016 – 05.12.2016

Main activities

- Design and preparation of the experimental stand based on the needs of beneficiary, correlated with the available norms and codes
- Experimental testing a total of 18 specimens, 3 elements types (4 Φ /80x85cm, 6 Φ /80x85cm, 6 Φ /100x120cm) in 2 static scheme, 3 specimens for every variables.
- Determination of deflections and crack width for every load step.
- Assessment of the behavior based on cracking mode, crack distribution and propagation, as well as failure modes.
- Elaboration of research report.

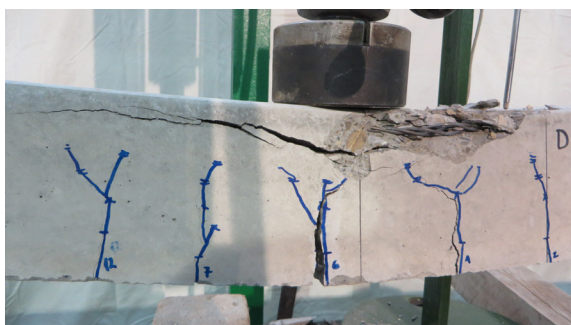

Results

The most relevant result consists in:

- Dimensions of the elements are in conformity of the SR EN 12843:2005 code requirements.
- Geometrical deviations of the specimens are within accepted limits.
- Tested specimens behaved as expected compared with similar type of elements.
- Cracking mode of the elements were specific for prestressed elements.
- Test results were uniform from ultimate force and deflection point of view.
- Important differences in ultimate load bearing capacity were observed when a static schemes were modified.

Applicability and transferability of the results

The experimental results obtained within the project will be introduced in an advanced calculation model for such small cross sections prestressed concrete elements. Results could be used to improve design and construction practice.

Financed through/by

S.C. BAUELEMENTE S.R.L. through research project BC85/2016

Research Centre

Research Centre for Retrofitting of Constructions – RECO,
Politehnica University of Timisoara

Research team

Prof. Daniel DAN
Assoc. Prof. Tamás NAGY-GYÖRGY

Contact information

Assoc. Prof. Tamás NAGY-GYÖRGY, PhD
Faculty of Civil Engineering
Department of Civil Engineering and Building Services
Address: 2nd T. Lalescu, 300223, Timisoara
Phone: (+40) 256 4039 35
E-mail: tamas.nagy-gyorgy@upt.ro
Web: <http://www.ct.upt.ro/en/cci/index.htm>

FIELD AND LABORATORY INVESTIGATIONS CONCERNING THE GROUND OF THE SAFETY LANE (RWY STRIP) AND THE SAFETY AREA PERTAINING TO THE TAKE OFF/LANDING RUNWAY (RESA)

Goal of the project

The technical report aims at realizing field and laboratory investigations concerning the improvement of the ground of the safety lane of the runway (RWY STRIP) and the safety areas pertaining to the take off/landing runway (RESA), as well as offering solutions to make these areas adequate to the requirements of the technical regulations in the aeronautic field.

It is recommended that the objectives be built to minimize the dangers induced by a possible faulty taxiing, or by the differences in bearing capacity.

Short description of the project

The report consists in researching the characteristics of the ground on the runway through in situ and laboratory testing. The following characteristics have been determined: - for the ground in the area: grading, plasticity, consistency index; layering of the ground in the runway strip through geotechnical drilling and sounding; the bearing capacity of the ground through light dynamic penetration (PDU) and the Californian bearing Ratio. The required value of the resistance parameter (CBR) of the soil ranges between 15 and 20%. In the case of inaccurate values, the laboratory study offered major technical solutions to obtain the required performances in respect to the bearing capacity, such as:

- stabilization with special hydraulic binders;
- mechanic stabilization.

Project implemented by

S.N. AEROPORTUL INTERNAȚIONAL TIMIȘOARA TRAIAN VUIA S.A
TRAIAN VUIA INTERNATIONAL AIRPORT TIMISOARA SA

Implementation period

01.03.2016 – 01.07.2016

Main activities

- identification of the stratigraphic succession of the soil layers in the foundation ground;
- determination of the underground water level;
- determination of the physical-mechanical characteristics of the soil layers in the foundation ground, through laboratory analyses and tests;
- determination of the resistance to shearing stress Φ and c for the undisturbed samples through unconsolidated-undrained direct shearing (13x3 samples);
- determination of the CBR index (Californian Bearing Ratio) for the undisturbed soil samples (13 samples);
- determination of the optimal compaction moisture through the normal Proctor test (5 samples).

Realization of homogenous soil mixtures by adding different percentages of special hydraulic binder, 2%, 4% and 6% respectively.

Results

The application of a 70/30 soil/gravel ratio with the CBR index of minimum 22% is recommended for mechanical stabilization.

The stabilization with special hydraulic binders requires the application of a dosage of 4% binder in the mixture for which a minimum 26% CBR index is obtained (28 days). Even with an adequate CBR index for a 2% binder stabilization, a 4% hydraulic binder dosage is recommended, in order to ensure a high quality behavior of the material in the accidental presence of infiltration waters.

Applicability and transferability of the results

The results obtained intend to ensure the required bearing capacity $CBR = 15 \dots 20\%$, for the take off/landing runway strip RESA.

Research Centre

Research Centre of Infrastructures for Constructions and Transportation – ICT –

Research team

Project manager:

Lecturer Paul MARC, Ph.D, Eng.

Team members:

Assoc. Prof. Ion BOGDAN, Ph.D, Eng.

Assoc. Prof. Ioan Petru BOLDUREAN, Ph.D, Eng.

Lecturer Monica MIREA, Ph.D, Eng.

Lecturer Alexandra CIOPEC, Ph.D, Eng.

Lecturer Luiza ROMAN, Ph.D, Eng.

Eng. Andrei FORTON PH.D, Student

Eng. Alin BUZURIU, Ph.D, Student

Contact information

Lecturer Paul MARC, PhD, Engineer

Department Address: Str. Ioan Curea, No.1A, Postal Code 300224, Timișoara

Phone: (+40) 256 403 972

Mobile:0744690884

E-mail: paul.marc@upt.ro

Web: <http://www.ct.upt.ro/cctfc/index.htm>

TECHNICAL AND GEOTECHNICAL REPORTS FOR THE REHABILITATION WORKS ON DN76, IONEȘTI – VÂRFURILE, KM 55+425 – KM 69+350 – TECHNICAL REPORT ON ROAD SUPERSTRUCTURE

Goal of the project

The technical report aims at assessing the executed works, starting from the site documents drawn up during construction, as well as at proposing technical solutions which can be applied for finalizing the works.

The theme of the report requires the highlighting of the existing technical condition of the road structure and the proposition of viable alternate solutions to continue the rehabilitation, ensuring the technical and qualitative performances while speeding up the work rhythm.

Short description of the project

Research for proposing viable technical solutions to finalize the works.

Project implemented by

S.C. ALDOR S.R.L. Timișoara

Implementation period

01.03.2016 – 01.07.2016

Main activities

The assessment of the national road section to be rehabilitated, DN 76 Ionești – Vârfurile, km 55+425...km 69+350, consisted in determining the present performance indices for the realized works, as follows:

- assessment of the bearing capacity;
- assessment of the deterioration;
- assessment of evenness;
- assessment of traffic;
- assessment of road structure composition;
- condition of the realized works.

Based on the results obtained from the afore-mentioned verification, conclusions were drawn up concerning the quality of the realized works (enlargement casing) and the technical condition of the existing road section.

Results

The investigations lead to the following conclusions:

- the realized casings differ in aspect from one section to the other or even on the length of the same section;
- the research performed shows diverse and extended degradations, multiple repairing works, totally inadequate evenness and bearing capacity at the level of the road surface, aspects arguing for the necessity of strengthening the road complex;
- the field research shows that the quality conditions are adequate at the upper side of the analyzed casings, and their bearing capacity is at least equal to the one in the existing road complexes;
- the geotechnical drillings show that the existing road layers have variable thickness, are realized in different materials and are placed on foundation grounds with low bearing capacity.

Applicability and transferability of the results

Based on the analysis of the existing situation, the following technical solutions were analyzed:

- strengthening of the existing road complex with new bituminous layers;
- realization of new foundation layers, with or without milling the existing bituminous layers;
- application of a cold recycling technology in situ on the existing road layers.

The recommended technical solution includes the leveling of the bearing capacity on the entire width of the carriageway by applying an in situ stabilized layer with hydraulic and bituminous binder, followed by the realization of a bituminous pavement.

Research Centre

Research Centre of Infrastructures for Constructions and Transportation – ICT –

Research team

Prof. eng. Florin BELC, Ph.D.

Prof. eng. Gheorghe LUCACI, Ph.D.

Lecturer Paul MARC, Ph.D.

Eng. Alin BUZURIU, Ph.D. Student

Eng. Andrei FORTON, Ph.D. Student

Contact information

Prof. eng. Florin BELC, Ph.D.

Faculty/Department Address: Str. Ioan Curea, No. 1a, Postal Code 300224, Timișoara

Phone: (+40) 256 403 965

Mobile: (+40) 723 125 152

E-mail: florin.belc@upt.ro

RESEARCH AND INVESTIGATION REGARDING THE QUALITY IMPROVEMENT AT 3D MEASURING OF INJECTED PLASTIC PARTS

Goal of the project

To transfer knowledge to the technical staff from the quality department in order to improve the quality of the parts by understanding the geometrical product specification method (GPS) and the 3D measuring strategies used to measuring the injected plastic parts from the automotive industry.

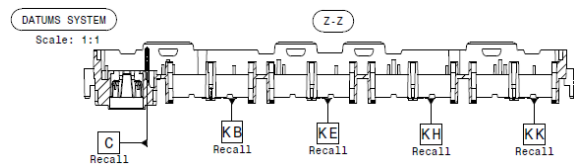
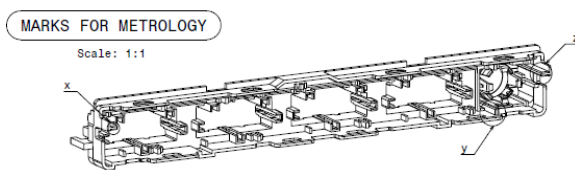

Short description of the project

Developing the 3D measuring strategies for the injected plastic parts according to the GPS.

Project implemented by

3D Measuring Laboratory/Quality department, S.C. PLASESS SRL, Romania

Implementation period

21.07.2016 - 30.09.2016

Main activities

- study the real plastic parts and their drawings
- identify the datums and define the parts coordinate systems
- establish the measuring strategy in Tactile Coordinate Metrology, according to the characteristics of the part, shape, accuracy and the quality of the real part (warpage of the part caused by shrinkage)
- 3D measuring program: datums measuring, features measuring, establishing the number of measuring points and their distribution on the surface
- 3D measuring of the plastic parts on a CMM with contact sensors
- analyse the measuring results and establish the factors which may lead to effects on the measuring result and measuring uncertainty

Results

Transfer to the technical staff of the company the drawings interpretation method according to the GPS, tolerance analysis and 3D measuring strategies in order to improve the quality of the products. For each plastic part studied were formulated conclusions regarding the measuring strategies and the factors which lead to the effects on the measuring results and measuring uncertainty.

Applicability and transferability of the results

All the research results are transferred to the company. These results lead to an improvement in 3D measuring process by reducing measuring time, costs and measuring uncertainty. Based on these results, in the mold testing phase, some corrections at the injection mold can be made. During the part production period the results could be used to change the injection process parameters in order to fit the part in the technical specifications.

Financed through/by

S.C. PLASESS SRL, Romania

Research Centre

Integrated Engineering Research Center

Research team

Conf.dr.ing. Tulcan Aurel
Conf.dr.ing. Stan Daniel
Ș.L.dr.ing. Tulcan Liliana
Asist.dr.ing. Pop Florina
Asist.dr.ing. Pop Cristian

Contact information

Conf.dr.ing. Aurel TULCAN, PhD
Faculty of Mechanical Engineering
Department of Materials and Manufacturing Engineering
Bld. Mihai Viteazu nr.1, 300222-Timisoara
Phone: (+40) 256 403619
Mobile: 0751 092476
E-mail: aurel.tulcan@upt.ro

COMPLEX STUDY BY NUMERICAL SIMULATION AND MONITORING IN SITU, ON THE OPORTUNITY OF RELOCATING THE STATION TIM-I OF THE NATIONAL NETWORK OF AIR QUALITY MONITORING TOWARD TWO OTHER POTENTIAL NEIGHBORING LOCATIONS. OPINIONS REFERRING TO ITS MONITORING CAPACITY IN A NEW LOCATIONS.

Goal of the project

The scope of the project is to determine a novel position for an existing monitoring station from the national monitoring system of Romania, situated in Timisoara, as a traffic station and named TM1. The development of the city needs the prolongation of the public transport lines, in terms of an extension of the tram line, which is supposed to pass over the present position of TM1. Thus the relocation of the traffic station is analyzed critically, from the point of view of (i) respecting the present EU legislation on air quality, and (ii) in respect to offering the most beneficiary and representative opportunities for monitoring.

Short description of the project

- Online air quality campaigns accomplished on a traffic & residential zone from Timișoara, Romania by the UPT accredited lab;
- Dispersion modeling of several episodes, in three potential locations;
- Correlation between the values measured, with the values generated by dispersion modeling, under the same conditions, in the same location;
- Comparison between the values measured by the accredited lab and those generated by TIM-1.

Project implemented by

Local economic and administrative bodies, under the coordination of City Hall Timisoara - in order to achieve a possible implementation in the next future, based on the results of the project, supporting administrative, legal decisions.

Implementation period

May 2016 - December 2016

Main activities

- Study of the relocation possibilities. Planning the strategy of the measuring campaigns (on line, in situ);
- Calibration of the instrument, according internal procedures of the lab;
- Calculation of the concentrations measured and graphical representation of the Results of online air quality campaigns accomplished on a traffic & residential zone from Timișoara, Romania;
- Results of dispersion modeling of several episodes, in three potential locations
- Correlation between the values measured, with the values generated by dispersion modelling, under the same conditions, in the same location

Results

- Very good correlation between the NO measured values, both by the accredited lab, as well by the official station TIM-1.
- Lack of evidence for some concentration values for species through the TIM 1 station, especially PM measurements

Applicability and transferability of the results

- The relocation of the present TIM1 to another position is possible, by maintaining the representativeness of the measured values, in terms of air quality;
- Research results permit comparisons and conclusions, the values recorded by the accredited lab being very important and more complex, as these offered by the fixed traffic station TIM-1, in the present position/shape;
- The development of the city transport system can be continued / prolonged; the new location fits the present legislation regarding the location of traffic stations, in terms of air quality monitoring.
- The simultaneous measurements organized, offering the possibility of a comparison between measured values by two stations/labs (one accredited lab and one official Lab TIM1), support the research conclusions, as well developing of a novel method for impact depicting of a certain source upon a specific point. .

Research Centre

Research Centre for Thermal Machines & Equipments, Transportation and Environmental Pollution Control

Research team

Technical staff:	Administrative staff:
IONEL IOANA	ROGOZ ANCA
BISORCA DANIEL	BRATEANU GAVRIL
BALOGH MIHAI RAMON	NAGY GABRIELA
CALINOIU GABRIELA	

Contact information

Prof. Ioana IONEL, PhD
Faculty of Mechanical Engineering
M. Viteazu 1, 300222, Timisoara
Phone: (+40) 256 403670
Mobile: (+ 40) 723349337
E-mail: prenume.numa@upt.ro
Web: www.mediu.ro

RESEARCH ON WOOD RESIDUES POWERED STEAM BOILED FOR ENVIRONMENTAL IMPACT EVALUATION

Goal of the project

The project results are used by the beneficiary to estimate with high accuracy the emitted pollutants (particles, VOC's, CO, NO_x, SO₂, CO₂) monthly/yearly balance in compliance with relevant national and European legislation.

Short description of the project

The project consist in measurements of relevant pollutant concentrations (VOC's, particles, CO, O₂, NO, NO₂, NO_x, SO₂, CO₂) emitted a wood residue powered steam boiler stack, corroborated with thermodynamic parameters of the flue gases.



Extended reports are prepared in accordance with EU legislation and laboratory quality standard EN 17025:2005. Additional studies were performed regarding the efficiency and optimization of facility pollutant reduction systems, such as particle fabric filters mounted between steam boiler and exhaust stack. Study on potential recovery of heat losses with exhaust gases are also of interest.

Project implemented by

Faculty of Mechanical Engineering / MMUT Department

Implementation period

01.06.2016 – 20.12.2016

Main activities

- Periodic measurements campaign for flue gas pollutant concentrations (VOC's, particles, CO, O₂, NO, NO₂, NO_x, SO₂, CO₂).
- Periodic scientific reports in accordance with laboratory quality standard EN 17025:2005.

Results

A significant database comprising air pollutants emissions for large steam boilers powered by waste wood biomass.



Applicability and transferability of the results

Due to the wide spread of wood manufacturing facilities and the use of the large steam boilers powered by waste wood residues (biomass) the resulted database of air pollutants concentrations emitted can be of interest for inter-comparison studies.

Financed through/by

WERZALIT LEMN TECH SCS

Research Centre

Research Centre for Thermal Machines & Equipment's, Transportation and Environmental Pollution Control

Research team

Popescu Francisc
Trif-Tordai Gavrilă
Cioablă Adrian-Eugen
Trif-Tordai Gabriela
Dungan Luisa Izabel

Contact information (Ex)

Assoc.prof. Francisc POPESCU, PhD
Faculty of Mechanical Engineering / Department MMUT, Address: Bv. Mihai Viteazu no.1, 300222, Timisoara
Phone: (+40) 256 403666
Mobile: (+40) 721 832730
E-mail: Francisc.popescu@upt.ro
Web: <http://mmut.mec.upt.ro/>

DIAGNOSTIC ANALYSIS OF MCA INVEST INDUSTRIAL SRL AND ELABORATION OF THE COMPANY'S DEVELOPMENT STRATEGY

Goal of the project

The goal of the project was to perform a diagnostic analysis of the company and to elaborate the company's development strategy along with the pertaining strategic plan.

Short description of the project

The project was a practical one which was based on the situation of a company from the transportation domain.

Project implemented by

The implementation was done through the contract with third parties BC13 / 2016

Implementation period

March 2016 – February 2017

Main activities

The main activities of the project were:

- Diagnostic analysis of the company – performed through interviews with the main people from the company, analysis of the company's financial accounting situation and the organization documents of the economic organization which resulted in drawing up the pertaining document which included the main directions for future action
- Support in carrying out the new organization chart, the visual identity of the company (new website, business cards, presentation brochures in Romanian and English)
- Assistance in hiring new employees
- Identifying new customers and assistance in concluding new contracts
- Elaboration of the company's development strategy

Results

- Diagnostic analysis of the company and the development strategy for the next 5 years
- New websites in Romanian and English for the transportation and repair shop activity
- Business cards and presentation brochures in Romanian and English
- Psychological profiles of the company's key employees
- Identifying new customers and signing 2 new contracts with them

Applicability and transferability of the results

The results can be applied in companies of this type from Romania. In addition the transfer of the work method can be done without problems in any other type of company.

Research Centre

Research Center in Engineering and Management

Research team

Prof.ing.dr.ec. Marian Mocan
Asist. dr.ing. Larisa Ivascu
Asist.dr.psih. Liliana Cismariu
PhD student ing. Cristian Dumitrache
Asist.dr.ing. Attila Turi
PhD student ing. Qualid Kherbach
PhD student ec. Simona Rus

Contact information

Prof. Marian MOCAN, PhD
Faculty of Management in Production and Transportation
Management Department
Remus Str. 14, 300191 Timisoara
Phone: (+40) 256 404284
Mobile: (+40)722 356292
E-mail: marian.mocan@upt.ro
Web: www.mpt.upt.ro

PATENTS

EVOLUTION OF PATENTS UNDER AFFILIATIONS OF PUT 2012 - 2016

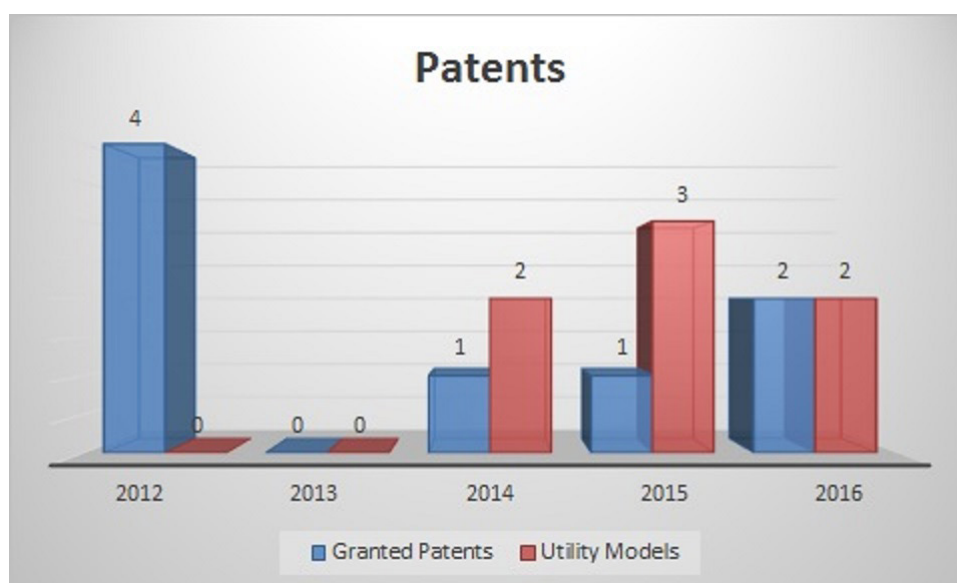

The innovative capacity of the Politehnica University of Timisoara is supported by teachers and scientific researchers through patents and utility models invented, presented in this section.

Granted Patents

INVENTOR: PINCA-BRETOTEAN CAMELIA
PATENT NO. 126966/2016

EXPERIMENTAL PLANT FOR RESISTANCE TO THERMAL FATIGUE



The invention relates to an experimental plant for laboratory research of thermal fatigue. The facility allows experimental research on thermal fatigue on common metal samples whose section has different shape and sizes. Those samples are approximately equal in size and are mounted tangentially on the generator disk. The facility provides cyclic variations in temperature of samples during intervals ordered according to the samples' material features.

The system has also some advantages: it is providing the experimental determination of thermal fatigue on several samples different in shape and size and who are simultaneously subject to different heat stress regimes; it is much more modern than traditional experimental determination of thermal fatigue referring to metal samples subject to different cyclic thermal regimes; it significantly reduces time spent for performing experiments about thermal fatigue determination in case of metallic materials operating under variable temperature; heating temperature of the samples inside the furnace may be imposed and maintained at the desired limit, up to 9000, and can be recorded numerically and graphically on the computer; at the bottom, under the furnace, rotating evidence are cooling in different environments, such as air jets, water spray, dry ice in tubes or fire extinguishers and its variations can be recorded digitally on the computer; heating and cooling cycle of the samples can be modified depending on the number of revolutions of the spindle and of the electric motor drive through the control panel of the static frequency converter.

The constructive scheme of the installation to determine thermal fatigue resistance is shown in Figure no. 1, where an electric motor 1 controlled by a static frequency converter 2 which drives the main shaft 3 is assembled and mounted on the metal frame 4. Overlapping the samples mounted on the main shaft, there is a semicircular furnace 5 who is ordered to perform sample heating. At the end of the main shaft, as opposed to drive electric engine, there is the thermo-tension collector 6 which takes the electric signals from thermocouples whose wires are connected to the contact brushes rings. Disk supports are mounted on the main shaft - intermediate 7 and sideward 8, with screwed samples mounted on the generators 10. Support disks are mounted according to the length amongst samples and to the intermediate bushes 11 and end bushes 12; system hardening is achieved by means of interior screws 13 and pressure collar 14. Thermocouples are mounted placed on two opposite samples 15, with corresponding response inertia corresponding to operating cycle of the machine parts that were subject to thermal fatigue.

The principle of investigations on experimental plant designed and built in two stages involve mounting two testing samples arranged opposite on the disk circumference of the thermocouple, and each are connected to a thermo-tension collector. The experimental plant is presented in fig.no.2.

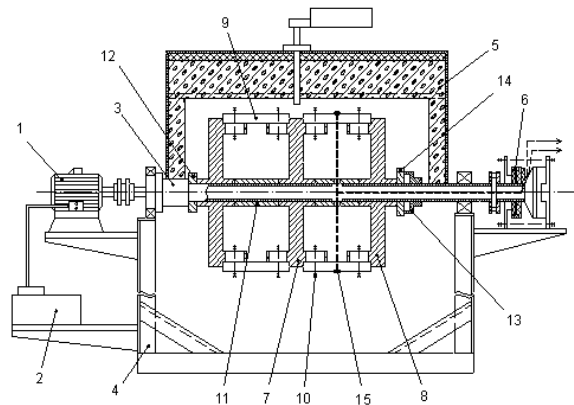

Fig.1 The constructive scheme of the installation to determine thermal fatigue resistance



Fig.2 Experimental entire plant

INVENTORS: GHEJU MARIUS TRAIAN, PODE RODICA, IOVI AUREL, BALCU IONEL,
COHECI LAURA, CIOPEC MIHAELA ELVIRA
PATTENT NO. 127099 /2016

PROCESS FOR HEXAVALENT CHROMIUM REMOVAL FROM WASTEWATER



The rapid industrialization and urbanization have brought with them a more and more heavy pollution of the entire environment. One of the most difficult problems to solve is the problem of waters contaminated with various pollutants. From the different types of pollutants, heavy-metals are particularly dangerous, both due to the toxic effects of metals and due to the fact that the natural conversion of metals in less toxic species (when this process is possible) take place over long time periods. Chromium is an important metal with widespread use in various industries such as electroplating, wood preserving, steel manufacturing, metal finishing, leather tanning, corrosion control, textile dyeing, manufacture of ceramics and pigments etc. As a result, large quantities of this metal have been discharged into the environment due poor storage practices, improper disposal or leakage of chromium waste. In natural environments, chromium can exist mainly in two oxidation states: (+III) and (+VI). Among these two, Cr(VI) exerts the most toxic effects on living organisms, having also the highest mobility in the environment. Therefore, it is important to reduce the concentrations of Cr(VI) in wastewaters below the permissible limits, before being discharged into environment. The most used method for the removal of Cr(VI) from wastewaters is by chemical reduction to Cr(III) followed by precipitation. The innovative element brought by our patent is that, instead of using conventional reducing agents (FeSO_4 , SO_2 , Na_2SO_3 , $\text{Na}_2\text{S}_2\text{O}_4$, $\text{Na}_2\text{S}_2\text{O}_5$), we will use a cheap and locally available industrial waste: scrap iron from the mechanic processing of steel.

This way, some of the goals of sustainable development are achieved: waste recycling (scrap iron, in our case), water recycling, and environmental protection. In this patent we propose the continuous process of Cr(VI) removal from aqueous solutions, by reduction to Cr(III) with scrap iron coupled with precipitation of the resulted cations. The optimal conditions for Cr(VI) reduction with scrap iron are identified, as well as the optimal conditions for the separation of cations resulted from the reduction of Cr(VI) with scrap iron.

The invention describes a process for hexavalent chromium removal from wastewaters having a content of 1-100 mg/L of Cr(VI).

According to the invention, the process consists in reduction of hexavalent chromium to trivalent chromium with scrap iron, at pH 2.5 and a contact time of 1-2 hours. The column effluent is then directed to the mixing chamber of a clarifier where the pH is corrected to 8.3 with NaOH 30%. After a settling time of 5 hours, concentrations of total chromium and total iron in the clarifier effluent are within the maximal limits admitted for the discharge into the sewage system (NTPA002).

The wastewater treatment setup comprises:

- (1) - pH correcting basin;
- (2) - H_2SO_4 storage tank;
- (3) - NaOH storage tank;
- (4), (5) and (7) - pumps;
- (6) and (11) - stirrer;
- (8) - activation/reactivation/reduction column;
- (9) - scrap iron filling;
- (10) - horizontal clarifier.

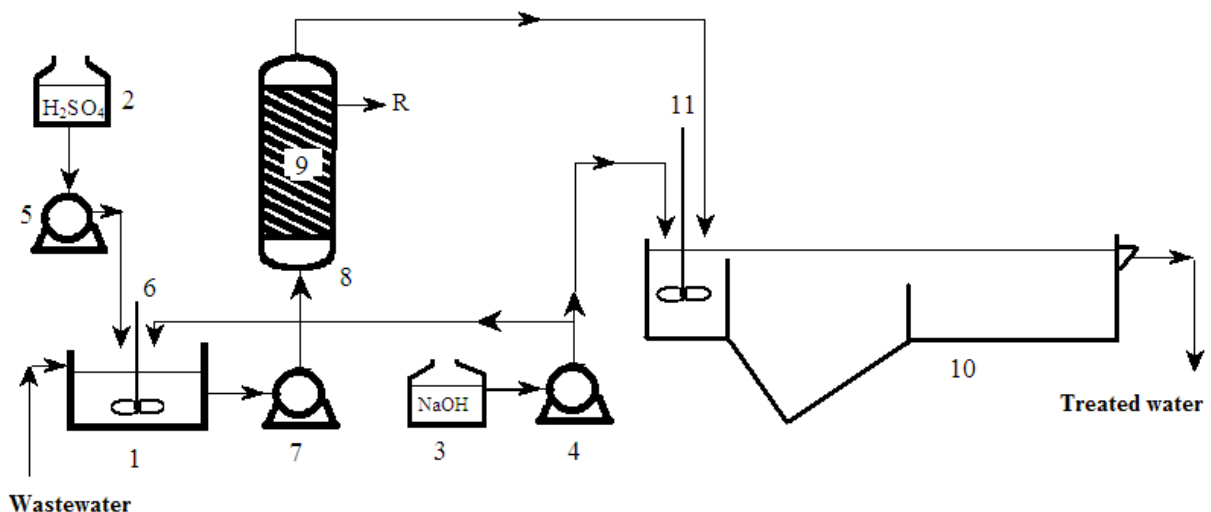

Utility Models

INVENTORS: SEBARCHIEVICI CĂLIN, SÂRBU IOAN, IACOB MIHAI
UTILITY MODEL NO. RO201300054

AUTOMATIC CONTROL DEVICE FOR HEATING SYSTEMS



The technical problem solved by the invention is to provide a device for pump's speed control automatic adjustment based on monitoring the ambient temperature in order to optimize electrical and thermal energy in the system.

According to the invention, the automatic control device for heating systems ensures the speed control of the heating system supply pump through a programmable logic controller (PLC) that uses information from interior and exterior temperature sensors. The command of the PLC is submitted to a frequency converter that commands the pump's speed and its start-stop function in order to reduce energy consumption.

The automatic device for heating systems according to the invention has the following advantages:

- ensures the heating system optimization by automatic speed pump adjusting;
- provides thermal energy and electricity savings;
- leads to improved boiler efficiency (running on natural gas, oil or solid) that is used to prepare the thermal fluid for space heating;
- helps to improve the heat pumps' (air-water, water-water or ground-water type) seasonal coefficient of performance.

INVENTOR: PAVEL ȘTEFAN
UTILITY MODEL NO. RO201500055

PORTABLE DEVICE FOR SIGNALING PAIN, SENSITIVITY OR DISCOMFORT DURING THE COURSE OF MEDICAL DENTAR ACTIVITY



The invention refers to a portable electrical device for signaling pain, sensitivity or discomfort during the course of medical dental activity. The electrical portable device for signaling pain, sensitivity or discomfort during the course of medical dental activity attachable to the dental unit (armchair) is composed out of an interlocking microcontact piece and/or optionally out of a glove attached to the patient's arm which contains an interlocking piece which is activated manually by the patient in case they feel pain or discomfort during the course of medical dental activity. The manual activation of the automatically restoring microswitch or of the contacts inside the glove interlocks a relay powered with a tension of 12 V which will command the activation of two independent transformers of 4.5V and 12V which, in turn, will power with electricity, optionally, the operation of a LED lamp, of a buzzer and of a micro speaker with pre-recorded voice signals installed inside a flexible piece of equipment and attached via a suction cup to the armchair. This equipment is also designed with microswitches which permit the simultaneous or independent activation of the light signal via the LED lamp, the acoustic signal via the buzzer and the voice signal via the micro speaker.

HONORARY MEMBERS

EVOLUTION OF HONORARY MEMBERS OF PUT 2012 - 2016

The conferring of honorary degrees is one way in which the University recognizes individuals distinguished by accomplishments consonant with the overarching mission of the University.

Nominees may be eminent scholars, scientists, artists, or professionals who have advanced their disciplines in important ways, or they may be individuals outside of the academic world who have made particularly distinguished contributions to society.

Politehnica University of Timisoara recognizes scientific excellence by conferring the honorary degree of Doctor Honoris Causa and Honorary Professor to distinguished Researchers for their contribution to the development of PUT and continuous support.

The University strives for a robust pool of honorary degree recipients enriched by individuals from all backgrounds of engineering.

We also find it rewarding to honor individuals who have not already been publicly recognized by a number of other institutions.

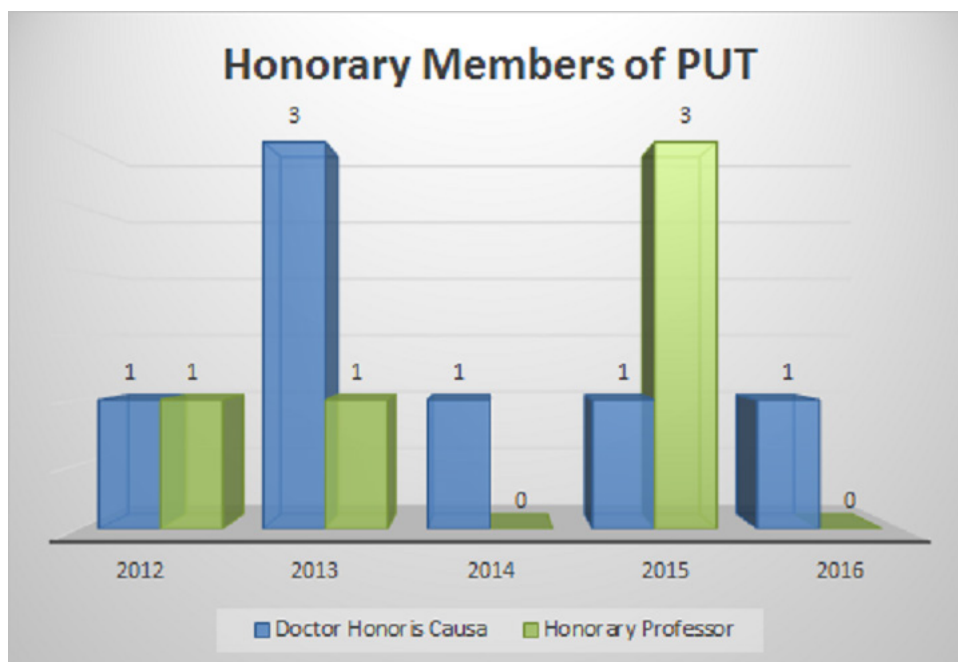

DOCTOR HONORIS CAUSA

Prof. Dr. Eng. Alin ALBU-SCHÄFFER – German Aerospace Center – DLR

Prof. Dr. Eng. Alin Albu-Schäffer, was born on October 20, 1968 in Timișoara. After graduating the “Nikolaus Lenau” high school in Timișoara, he attended the Faculty of Electronics and Telecommunications, Industrial Robots specialization, within the Technical University of Timișoara (today Politehnica University of Timișoara), where he received his Engineer’s Degree. His diploma paper focused on the application of neural networks in robotics, under the supervision of Prof. dr. eng. Virgil Tiponuş.

After 1990, the engineer Alin Albu-Schäffer moved to Germany, where he developed a professional career at the highest level at the Institute of Robotics and Mechatronics within DLR.

In 1995, he enrolled in a PhD program at the Technical University of Munich, Department of Electrical Engineering and Information Technology. In 2002 he defended his PhD thesis, under the supervision of the renowned specialist in Robotics, Prof. Dr. Eng. Gerhard Hirzinger.

He started his career path within DLR first as a research engineer, and then, in 2005 he became the coordinator of the research group “Intelligent Manipulation Group”, conducting numerous national and international research projects. Between 2009 and 2013, he was the Head of the Mechatronic Components and Systems Department.

DLR is the National Aeronautics and Space Research Center of the Federal Republic of Germany (das Forschungszentrum für Luft- und der Bundesrepublik Deutschland Raumfahrt).

Research and development activities focus on aeronautics, extra-terrestrial space research, development of green technologies for power supply and methods of using it effectively in communication, transport, and security systems. DLR is also the space agency of Germany and bears the responsibility for planning and implementing the German space program, as assigned by the federal government.

In July 2012, Dr. eng. Alin Olimpiu Albu-Schäffer became the Director of the Institute of Robotics and Mechatronics, and then a representative of all three research institutes, reunited in the RMC competence centre of DLR for research and development in robotics, mechatronics and optic systems.

As a recognition of his scientific results, in 2013 he was appointed professor at the Technical University of Munich, Department of Computer Science, and then guest professor at prestigious universities in the European Union (Twente University, Netherlands, Technical University of Vienna).

The entire scientific activity of Dr. Eng. Alin Albu-Schäffer was mainly targeted at the field of robotics (development, control), with significant theoretical contributions in:



- Modelling and control of robots systems;
- Nonlinear control techniques;
- Development and control of mechatronic systems;
- Development and control of autonomous robots;
- Assembly systems based on artificial sight intelligence and;
- Functional robots in the extra-terrestrial space;
- Medical robotics;
- Softrobotics;
- Light and compliant robots;
- Intelligent sensors.

His remarkable results obtained in research and innovation, respectively in research management, include numerous significant German and European projects, including “PHRIDOM” (Physical Human-Robot Interaction in Anthropic Domains), “PHRIENDS” (Physical Human-Robot Interaction: Dependability and Safety), the European Project VIATORS, the 5 registered patents in the field of mechatronic control systems, etc.

His two decade-long experience in their fields of robotics and nonlinear control was appreciated by invitations received for disseminating knowledge to specialists from other countries, such as:

- Lectures on the following disciplines in the curriculum of the Master's programme in Robotics, Computer Science and Mechanical Engineering, Technical University of Munich: "Robot Programming and Control for Human Interaction" (from 2014), "Sensor based robotic manipulation and locomotion" (from 2013), and "Control Methods in robotics" (between 2007-2012),
- Supervision of PhD programmes and member of PhD committees at renowned universities in Germany, Belgium, Sweden, Italy, Spain, Holland, etc.,
- Visiting Professor at famous universities in the European Union.

The recognition of his scientific merits and of his professional experience was extended in Germany but also internationally, Dr. Eng. Alin Albu-Schäffer being thus elected in many prestigious professional structures:

- Associate Editor of IEEE Transactions on Robotics (2008-2012);
- Board of Directors in its EU-Robotics AISBL, the first European organization in Robotics;
- Founding member of EU Topic Robotics, Mechatronics Group;
- Coordinator of the group "Robot Control" VDI/VDE (Verein Deutscher Ingenieure / Verband der Automobileindustrie) (2009-2014);
- Member in the Scientific Board of DLR;
- Member in evaluation committees of some research institutes:
 - Robotics at the „Institute National de Recherche en Informatique et en Automatique" - INRIA, France, 2009
 - Institute of Planetary Science, DLR, Berlin, 2013
 - Institute of Flight Systems, DLR, Braunschweig, 2015
- Member of specialized PhD committees at renowned universities in Germany, Belgium, Sweden, Italy, Spain, the Netherlands.

His scientific papers received numerous national and international distinctions, among which are worth mentioning those obtained at IEEE conferences, in his fields of activity:

- Dr. Eng. Alin Albu-Schäffer was elected IEEE Fellow, for contributions to light and compliant robots, Piscataway, New Jersey, USA, January 2016;
The title IEEE Fellow is conferred by the IEEE Board of directors on a person who registered outstanding results in one the research areas affiliated to the IEEE world-renowned association.
- IEEE King-Sun Fu Best Paper Award of the Transactions on Robotics for the paper "Robots Driven by Compliant Actuators: Optimal Control Under Actuation Constraints", 2014,
- IEEE King-Sun Fu Best Paper Award of the Transactions on Robotics for the paper "Human Like Adaptation of Force and Impedance in Stable and Unstable Interactions", 2012,

- IEEE International Conference on Intelligent Robots and Systems (IROS 2012) Best Video Award, as Coordinator of the VIATORS consortium, 2012,
- IEEE International Conference on Intelligent Robots and Systems (IROS 2012), IROS 2012 Best Jubilee Video Award, with a summary of DLR research results on variable compliance actuator robots, 2012,
- EU-Robotics TechTransfer Award, on behalf of DLR, together with Ralf Koeppel (KUKA), for the technology transfer of the light-weight robot, Vasteras, 2011, etc.

Publications

The experience gained as a result of his research and development activity, allowed Prof. dr. eng. Alin Albu-Schäffer to write a large number of scientific articles, published in renowned journals recognized, conference proceedings and collective volumes (as guest expert). Some of his most remarkable publications include:

- more than 40 articles published as Journal articles or Book chapters;
- more than 140 articles published as "Peer reviewed conference articles".

Relations with Politehnica University of Timișoara

As a graduate of the Politehnica University of Timișoara, prof. Alin Albu-Schäffer was – over the years – in permanent contact with Timișoara and with Politehnica University. He regularly visited the old Alma Mater, the Faculty of Electronics and Telecommunications and the Mechatronics Department of the Faculty of Mechanical Engineering. He participated in numerous scientific conferences held in PUT; he was invited and accepted unreservedly to lecture for teachers, PhD and BS students with concerns in the areas of robotics, automation and mechatronics. The lectures, some of which are listed below, were given at a very high scientific and technical level:

- "Developments in Robotics at the DLR Institute for Robotics and Mechatronics" ISETc Symposium, 2006;
- "Light robotic arm KUKA - DLR" 2008;
- "Fundamentals of engineering management in robotics, the lecture for the discipline Intelligent robots at the Department of drives and automation", TU Munich, 2010;
- "Human-robot cooperation: From outer space to Earth," 2014;
- "From the benches of PUT to the top of European technology, HRD project, OVDIP at UPT: "Soft parts robots, sensitive and compliant robots, robots interacting with the human operator and unknown environments", 2015.

Prof. Alin Albu-Schäffer promoted and collaborated with the Politehnica University, by facilitating the visits of some PUT faculty members to the prestigious research institution in Germany. He has also created opportunities for the UPT youth to conduct specialising or training sessions in the DRL labs for different periods of time.

HABILITATION THESIS

EVOLUTION OF HABILITATION THESIS IN PUT 2012 - 2016

Habilitation (from Latin *habilis* "fit, proper, skillful") is the highest academic qualification a scholar can achieve by his or her own pursuit.

In this chapter we present the habilitation thesis supported by teachers from Politehnica University of Timisoara, both at PUT and, also, at other universities.

The habilitation thesis are presented in chronological order, according to institution where they were sustained.

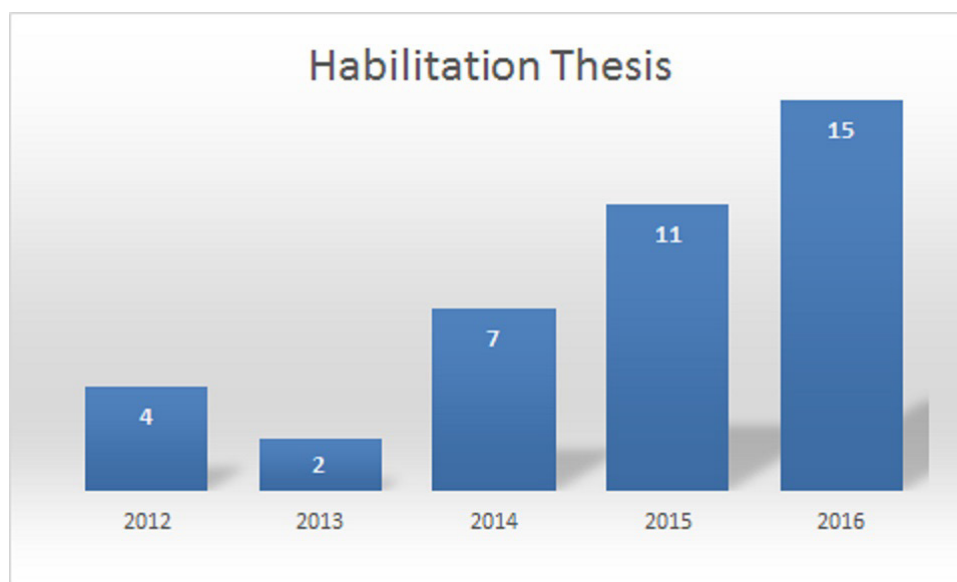

CONTRIBUTIONS ON DEVELOPMENT OF MECHANISM SCIENCE WITH APPLICATIONS IN ROBOTICS, MECHATRONICS AND MECHANICAL ENGINEERING

Author: Erwin-Christian LOVASZ

Abstract

The present habilitation thesis was structured in five sections and covered the scientific, academic and professional achievements from the period 1998 to 2015.

Section (I) give an overview of the thesis content and shows the highlighted papers which were published by the author in prestigious Journals and Conferences.

The Section (II) described some of the scientific achievements within the author's research directions and was organized in four chapters. The first chapter "Scientific achievements regarding the design of the mechanisms using profiled wheels" shows the contributions on computing of the base circle radius and evaluating of the wear susceptibility of the cam mechanisms with translating or oscillating flat-face follower, and on the designing of different non-circular wheels of belt mechanisms for self-balancing applications. The second chapter "Scientific achievements regarding the design of complex mechanisms structures" laid out contributions in designing of geared linkages with non-circular gears and with linear actuation, respectively of 5-link belt mechanisms. The third chapter "Scientific achievements regarding of mechanism development for mechatronics, robotics and mechanical applications" presents some mechanism design and control applications for haptic exoskeleton used in space telerobotics, for a new class of planar parallel manipulators and for a fishing reel spool mechanisms. The last chapter "Scientific achievements regarding the analysis of compliant mechanisms" shows the research of the compliant mechanisms, which use elastic connections, focused on the structural analysis of the compliant mechanisms with elastic connections, simulation and dynamic analysis of the compliant mechanisms with or without integrated piezo-actuators.

The Section (III) of the habilitation thesis mentions the main academic achievements on national and international level of the candidate within the last 17 years after defending the PhD thesis in co-advisorship between University Politehnica Timișoara and Technical University Dresden, defended on 27th of February 1998 at TU Dresden and on 03 of June 1998 at UP Timișoara.



The Section (IV) shows the career evolution and development plans organized in the following systematization: Key research directions, Objectives, Planned activities and Financial, human and infrastructure resources.

The Section (V) contains the references used in the section "Scientific achievements".

The full abstract at:

http://www.upt.ro/img/files/2015-2016/doctorat/abilitare/lovasz/Abstract_Lovasz_Erwin.pdf

Habilitation Commission

Prof. Dan PERJU
Universitatea Politehnica Timisoara;
Prof. Marco CECCARELLI
Universitatea din Cassino;
Prof. Burkhard CORVES
Universitatea RWTH Aachen;
Prof. Niels MODLER
Universitatea Tehnica Dresda.

SANITATION CONSTRUCTIONS AND THEIR IMPACT ON THE ENVIRONMENT

Author: Constantin FLORESCU

Abstract

Experimental research results were made on a laboratory plant within the Department of Hydrotechnical Engineering, with water from Bega river and highlighted, efficiencies achieved with upward and downward filtration plants equipped with multiple layers, consisting of homogeneous material (quartz sand - for upward filtration) and inhomogeneous (polystyrene, anthracite, quartz sand, garnet and magnetite - for downward filtration).

The experimental research has shown upward filtration performance equipped with structures of homogeneous materials compared to those of the downward filtration. These results were obtained while the Bega water, used in the experiments, was made up of the colloidal suspensions obtained after a preliminary settling in the suction basin of the supply pumps from laboratory.

The main results of the thesis were presented at several national and international conferences and published in national scientific journals. The candidate has also been involved as a member or coordinator on several contracts and research projects at national and international projects and also with partners in production.

Habilitation thesis summarizes some of the research work of the candidate after obtaining doctoral thesis from the Politehnica University of Timisoara, in October 2005.

Selected activity proves original achievements and relevance of academic, scientific and professional contributions for an independent development of future career on the academic and research line.

The presentation of post-doctoral work it was conducted in two main directions: "Sanitation constructions", presented in Chapter 2, and "Environmental impact of sanitation constructions", presented in Chapter 3.

Scientific research results are materialized mainly through publications of scientific specialist articles and books, textbooks and laboratory and design guidance.

In recent years, the candidate was that the main priority, publishing scientific articles in journals and various scientific journals indexed in the Web of Knowledge (ISI), or in magazines and books of different scientific manifestations indexed in other relevant international BDI databases.



The candidate has published over 70 scientific papers, of which 13 in journals indexed in the Web of Knowledge (ISI) and 12 in other journals indexed in international databases BDI. Main achievements and results are presented in detail in Chapter: B. Scientific achievements, academic and professional.

Another important component of the candidate in Activity Research consists of worldwide documentation for scientific activities in civil engineering field. By engaging in specialized scientific committees, international events or publications, also the activity of scientific reviewer of publications, the candidate aims his training and development from professional and scientific point of view.

The research activity on main direction: "Sanitation constructions" presented in Chapter 2, refers to the centralized systems of water supply and sewerage in populated centers.

In the country, of the 13,842 localities, approx. 10% of them are equipped to European standards as regards the centralized systems of water supply and sewerage in populated centers. The most important European funds are currently allocated to this work.

A second direction for research activity refers to:

"The impact of sanitation constructions on the environment", presented in Chapter 3.

In general, sanitation works are constructions that ensure the protection of the environment.

The full abstract at:

http://www.upt.ro/img/files/2014-2015/doctorat/abilitare/florescu/Rezumat_teza_abilitare_FLORESCU_en.pdf

Habilitation Commission

Prof.PhD.Eng. Ion GIURMA

Technical University "Gh. Asachi" Iași;

Prof.PhD.Eng. Ioan BICA

Technical University of Civil Engineering of Bucharest;

Prof.PhD.Eng. Gabriel RACOVÎTEANU

Technical University of Civil Engineering of Bucharest.

SOLUTIONS FOR IMPROVED SEISMIC PERFORMANCE OF NEW AND EXISTING STRUCTURES

Author: Aurel STRATAN

Abstract

Habilitation thesis of Aurel Stratan presents his main scientific, professional and academic achievements following the defence of the PhD thesis at the Politehnica University of Timisoara, as well as the future development plan. The main research area of the author fits into the broad and multi-disciplinary area of earthquake engineering, with particular emphasis on seismic performance of steel structures and rehabilitation of existing buildings using metal-based solutions. The most important and relevant research directions pursued by the author are: "Re-centring eccentrically braced frames", "Cold-formed steel pitched-roof portal frames with bolted joints", "High strength steel in seismic resistant structures", "Seismic rehabilitation of existing reinforced concrete and masonry buildings with steel-based solutions", "Validation of the technical solution for braces with true pin connections", "Seismic performance of multi-storey steel structures with friction dampers" and "Prequalification of bolted beam to column joints with haunches". Experimental investigation methods represent the main tool of the research, supported at the same time by advanced numerical simulations and analytical tools. The habilitation thesis summarises the evolution of the research performed by the author following the defence of the PhD thesis, as well as the main outcomes, outlining also the context in which the research was performed, i.e. funding scheme, dissemination of results, and associated PhD theses. There were 12 grants supporting the research: 4 national grants, 7 international grants and 1 research contract with industry. The results were disseminated in 92 publications (journal and conference papers, and book chapters). Six PhD students were involved in the research (5 PhD theses were successfully defended and 1 is currently under development). Aurel Stratan had an active role in guiding the PhD candidates. Professional development of Aurel Stratan followed a wide pallet of activities, including participation to training courses, structural design, industry-oriented research, involvement in professional organisations and technical committees, code drafting, development of the research infrastructure, organisation of scientific events, short-term scientific missions, involvement in administrative duties and peer-review of scientific publications.



Aurel Stratan is member in several national professional organisations: AICPS, APCMR, AGIR-SBIS. He is also an active member in several national and international technical committees: Technical Committee TC13 "Seismic Design" of the European Convention for Constructional Steelwork (ECCS), CEN/TC 250/SC 8 "Eurocode 8: Earthquake resistance design of structures", CEN/TC 340/WG 5 "Revision of EN 15129 – Anti-seismic devices", ASRO CT 343 "Basis of design and structural eurocodes", CTS4 " Actions on structures", Ministry of Regional Development and Public Administration (MDRAP). He was member of the scientific committee of three conferences, member in the organizing committee of two conferences and chaired two sessions within international conferences.

The full abstract at:

http://www.upt.ro/img/files/2014-2015/doctorat/abilitare/stratan/Abstract_teza_abilitare_Stratan_en.pdf

Habilitation Commission

Prof. Raffaele LANDOLFO
University of Naples "Federico II";
Prof. Cosmin CHIOREAN
Technical University of din Cluj-Napoca;
Prof. Radu VĂCĂREANU
Technical University of Civil Engineering Bucharest.

TEMPERATURE AND ATMOSPHERE INFLUENCE DURING COMBUSTION SYNTHESIS OF METAL OXIDE (NANO)POWDERS

Author: Robert IANOS

Abstract

The habilitation thesis titled "Temperature and atmosphere influence during combustion synthesis of metal oxide (nano)powders" summarizes the most important scientific achievements published by the candidate after defending his PhD thesis in 2008. The research activity conducted by the candidate is mainly focused on the preparation of metal oxide (nano)powders via solution combustion synthesis.

Within this research field, the candidate has opened new perspectives by suggesting a number of innovative solutions to adjust and control the temperature and the atmosphere during combustion reactions, but also to remove the residual carbon by hydrogen peroxide, H_2O_2 , treatment. The feasibility and the efficiency of these approaches, presented in this habilitation thesis, have been recognized and validated by the international scientific community, as the obtained results have been published in prestigious ISI-ranked journals.

The superiority of the solutions suggested by the candidate enabled the combustion synthesis of a wide variety of materials, such as metal oxides, oxide compounds, oxide solid solutions and even composite materials: γ - Fe_2O_3 (maghemite), Fe_3O_4 (magnetite), $LaAlO_3$ (lanthanum aluminate), $CaZrO_3$ (calcium zirconate), $ZnAl_2O_4$ (zinc aluminate), $CoFe_2O_4$ (cobalt ferrite), $BaAl_2O_4: Eu^{2+}, Dy^{3+}$ (barium aluminate doped with europium and dysprosium), Fe_3O_4/C (magnetite/carbon composites).

Unlike many of the synthesis methods, which require an annealing step in order to obtain the desired crystalline compound, combustion synthesis has several advantages: it doesn't require annealing, is time and energy efficient, and last but not least is environmentally friendly. An additional advantage is that powder characteristics (surface area, crystallite size and grain size) prepared by combustion synthesis can be properly adjusted by changing the synthesis conditions.

From this point of view, the candidate points out that the most important parameters, namely temperature (higher or lower) and atmosphere (oxidizing or reducing) during the exothermic combustion reactions can be controlled, which is of vital importance



especially in the case of metal oxides containing cations which may adopt several numbers of oxidation.

The major role of temperature developed during the combustion reaction is discussed in the case of $LaAlO_3$, $CaZrO_3$, $ZnAl_2O_4$ and $CoFe_2O_4$ powder preparation. The importance of carrying out combustion reactions under reducing atmosphere is a major key in the case of Fe_3O_4 and $BaAl_2O_4: Eu^{2+}, Dy^{3+}$ powders. The final part of the main section presents an efficient solution to remove the carbon impurities from $ZnAl_2O_4$ or γ - Fe_2O_3 samples prepared by combustion synthesis, namely chemical oxidation with hydrogen peroxide, H_2O_2 . From the point of view of the influence of the procedure followed for residual carbon elimination on the main characteristics of $ZnAl_2O_4$ and γ - Fe_2O_3 powders, namely particle size and specific surface area, the removal of the residual carbon by hydrogen peroxide treatment is a superior technique to the conventional annealing.

The full abstract at:

http://www.upt.ro/img/files/2014-2015/doctorat/abilitare/ianos/Rezumat_teza_Robert_Ianos_RO.pdf

Habilitation Commission

Prof.univ.dr.ing. Rodica PODE
Universitatea Politehnica Timișoara;
Academician dr. Maria ZAHARESCU
Institutul de Chimie Fizică al Academiei Române "Ilie Murgulescu";
Prof.univ.dr.ing. Adelina IANCULESCU
Universitatea Politehnica București.

ASSESSMENT OF STRUCTURAL RETROFITTING AND ENERGY EFFICIENCY THROUGH TESTING, MODELLING AND MONITORING

Author: Tamás NAGY-GYÖRGY

Abstract

The present thesis briefly summarizes the most important scientific, professional and academic achievements of the candidate after defending his PhD thesis at the Politehnica University Timișoara. The candidate was member in 11 national and 5 international research grant or program, in 4 as coordinator. The main area of the researches was in the field of Structural Strengthening using FRP Composites (13 grants), while in the last 3 years interest was shifted towards to the Structural Health Monitoring and Energy Efficiency of structures.

The research performed on FRP Composites was focused on the development of new and innovative anchorage systems and strengthening technologies for reinforced concrete beams, on the study of the confining effect of carbon and glass fiber reinforced polymers (FRP) and their superposition with the application of innovative near surface mounted (NSM) steel and FRP bars were studied. Another subject was the investigation of the influence of various sized cut out openings created in structural walls and slabs retrofitted using externally bonded and NSM FRP composites. In parallel, the subject of advanced techniques used for structural strengthening of masonry elements was also performed. The efficiency of solutions was categorized in terms of resistance, ductility and costs, and a new strengthening solution was proposed and investigated, based on a new concept of steel wire mesh applied with epoxy resins. Use and application of FRP strengthening methods in the field of steel-concrete composite walls was also considered. One of the most promising results of the experimental program was a further development of an anchorage system used for FRP lamelas subjected to bending superposed with a confinement FRP fabric. Later on, full scale precast prestressed concrete element support zone was studied and the strengthening possibilities were analysed. Based on the initial nonlinear modelling, the strengthening strategy was determined and experimentally tested, than was followed by a numerical calibration and by an extension of the strengthening matrix.



The second subject of research covered by the candidate is related to the Structural Health Monitoring of Energy Efficient Buildings, in order to validate design principles, to evaluate real energy demands and to optimize and reduce energy consumptions. This field is time dependent, because it is based on recorded parameters throughout several years. In these on-going projects the objectives were to conceive, realize and put in function a complex monitoring system, to collect data from internal and external parameters and finally to provide a practice guide based on the results.

The full abstract at:

http://www.upt.ro/img/files/2015-2016/doctorat/abilitare/nagy-gyorgy/3_Abtract_Nagy-Gyorgy_Tamas_en.pdf

Habilitation Commission

Prof.univ.dr.ing. Nicolae ȚĂRANU
Universitatea Tehnică "Gheorghe Asachi" din Iași;
Prof.univ.dr.ing. György BALÁZS
Budapest University of Technology and Economics, Hungary;
Prof.univ.dr.ing. Zoltán KISS
Universitatea Tehnică din Cluj-Napoca.

GRAPHICAL PROGRAMMING IN MEDICINE, POWER ELECTRONICS AND MODERN EDUCATION

Author: Mihaela-Ruxandra LASCU

Abstract

Structurally, the habilitation thesis consists of a technical presentation regarding four main research topics:

◇ Electromagnetic compatibility - First a very powerful tool developed by the author for studying the magnetic field of shaped slotted screens is described. The next chapter is concerned with predicting the electrical behavior of metallisation patterns printed onto dielectric substrates. The last chapter presents a new test procedure for measuring the shielding effectiveness (SE) of shielded coaxial cables.

◇ Graphical programming in biomedical signal and image processing - The first part of this chapter will describe a computer based signal acquisition, processing and analysis system using LabVIEW. Peak detection in electrocardiogram (ECG) is one of the solved problems using LabVIEW and filtering biomedical signals in different ways is a challenge that has to be solved. The next topic presented is graphical programming in event detection using Pan-Tompkins algorithm. Then the design of an optimal Wiener filter is implemented to remove noise from a signal. Two programs for compression and Wiener optimal filtering are developed in MATLAB. Two algorithms were implemented in LabVIEW. In the last part a real-time 3D echocardiography and the corresponding algorithms that improve the quality of the image are presented. The second image application concerns the compression and noise removal of mammography images because these realize a preprocessing for the identification of microcalcification clusters in mammograms. A nonlinear method is implemented in LabVIEW for performing image enhancement. The final chapter reviews ultrasound segmentation methods, in a broad sense, focusing on techniques developed for medical ultrasound images.

◇ Solar Energy and Power Electronics - The first chapter introduces the first station in Romania (Eastern Europe) outfitted for systematic monitoring of solar irradiance on tilted surfaces. The second chapter concerns Power Electronics. It is related to small signal transfer functions derivation in quasiresonant converters (QRCs). A matrix



method based on state-space averaging of the PWM parent converter and switch cell conversion ratio is proposed.

◇ E-learning techniques - The first part presents a comparison between classical hands-on laboratories and remote laboratories. The second part describes aspects regarding an E-learning approach of resonant ac inverters. The learning process is based on "Learning by Doing" paradigm supported by several learning tools: electronic course materials, interactive simulation, laboratory plants and real experiments accessed by Web Publishing Tools under LabVIEW.

The full abstract at:

http://www.upt.ro/img/files/2015-2016/doctorat/abilitare/lascu/Rezumat_teza_abilitare_Mihaela_Lascu_en.pdf

Habilitation Commission

Prof.univ.dr.ing. Radu VASIU
Universitatea Politehnica Timișoara;
Prof.univ.dr.ing. Daniela TĂRNICERIU
Universitatea Tehnică "Gheorghe Asachi" din Iași;
Prof.univ.dr.ing. Dorin PETREUȘ
Universitatea Tehnică Cluj-Napoca;
Prof.univ.dr.ing. Florin SANDU
Universitatea Transilvania din Brașov.

CRYPTOGRAPHIC SECURITY FOR AUTOMOTIVE SYSTEMS

Author: Bogdan GROZA

Abstract

The thesis addresses the design of cryptographic protocols for assuring security on in-vehicle buses (e.g., the CAN bus) and various automotive components or functionalities (e.g., tire pressure monitoring sensors, vehicle access control by smart-phones). In the recent years, it has become increasingly obvious that vehicle evolution brings many similarities to that of modern computers. Not more than a century ago, computers were mere mechanical machines, then they turned into complex electronics and today they are loaded with complex software that (arguably) surpasses the complexity of the electronics behind it. Similarly, in the past decades, cars turned from mechanical devices into complex electronic devices and now they are loaded with hundreds of functionalities that are implemented in software. As an immediate consequence, the number of reported attacks has drastically ascended in the past years, with recent reports showing how one can lock the engine, steering wheels or brakes, etc. Our work is focused on the design of efficient broadcast authentication protocols taking into account the three most promising techniques: TESLA-like protocols based on key chains and time synchronization, group keying protocols where keys are shared between groups of nodes and one-time signatures. While some of these protocols proved highly efficient in sensor networks, this does not seem to be the case for in-vehicle networks that require extremely small authentication delays for preserving the real-time nature of the system. To assess efficiency, the proposed protocols were tested on automotive-grade micro-controllers as well as via simulation with industry standard tools. By the use of the CANoe tool we were able to simulate bandwidth allocation for the proposed protocols on state-of-art buses such as CAN-FD and FlexRay. The practical results proved our intuitions from the synthetic comparison of the protocols, i.e., group keying (LiBrA-CAN) is the preferred protocol design. Finally, our results also address the security of several in-vehicle subsystems starting from the generation of random numbers on embedded devices, smart-phone based vehicle access and security for wireless sensors. We do present our



most recent contributions in the security of wireless communication interfaces used in Tire Pressure Monitoring Systems (TPMS). Our work starts from designing an efficient authentication protocol based on lightweight cryptographic designs and block cipher based message authentication codes. The experimental results show that the proposed solution can be handled by real world sensors and is more efficient than alternative proposals. The works on smart-phone based car access and on randomness for automotive grade controllers, are recent developments and joint works with the industry.

The full abstract at:

http://www.upt.ro/img/files/2015-2016/doctorat/abilitare/groza/j_summary_en_BGroza.pdf

Habilitation Commission

Prof.univ.dr.ing. Victor PATRICIU
Academia Tehnică Militară;
Prof.univ.dr.ing. Sergiu NEDEVSCI
Universitatea Tehnică Cluj-Napoca;
Prof.univ.dr.ing. Vladimir Ioan CREȚU
Universitatea Politehnica Timișoara;
Prof.univ.dr.ing. Liviu MICLEA
Universitatea Tehnică Cluj-Napoca.

RESEARCH AND CONTRIBUTIONS IN ENERGY EFFICIENCY AND CONTEXT AWARENESS OF MOBILE SYSTEMS AND APPLICATIONS

Author: Marius George MARCU

Abstract

This habilitation thesis describes the achievements I have obtained since when I received the PhD scientific title of Politehnica University of Timisoara back in 2005, in the field of Computer and Information Technology. An overview of my activity and the main research work and topics is presented in the first section of the thesis. My recent activity addressed several research topics: energy-efficient and power-aware applications and systems, energy profiling of virtualization solutions, device and workload characterization using power signatures, indoor positioning techniques based on wireless infrastructures, component level energy profiling and runtime threadlevel energy accounting.

In these fields of expertise, I have published over 70 scientific and academic works as single author (9), first author (34) or co-author, 4 ISI journal with cumulative impact factor 2,74, 22 ISI proceedings papers, and 41 BDI journals and proceedings papers. I was also involved in more than 10 national and international projects obtained by competition, 4 of them as a project manager or local partner manager.

In Chapter 2 I describe the contribution to an execution framework for power-aware applications running on battery powered devices. This research direction has been supported by two national grants I have managed between 2006 and 2011. Power-aware applications are software applications that implement application specific power management algorithms in order to reduce and optimize the energy consumption of the system while running them. The main goal of this research effort was to promote power consumption management and optimization of mobile and embedded systems at higher abstraction layers of such systems. The main outcome of these projects was to establish a general theoretical background and applicative rules and patterns in order to obtain efficient mobile systems and applications from the point of view of the consumption and the prototype implementation of the framework.

In Chapter 3 I describe the contribution to energy efficiency profiling and evaluating of virtual machines. This work has been carried out during implementation of an FP7-ICT project eMuCo – Embedded



Multi-Core Processing for Mobile Communication. Our research effort explores how virtualization influences the power consumption of both physical systems and virtual systems and which is the most efficient way to implement such applications. The main goal of this work has been the study on the power consumption impact of virtualization solutions for common desktop and laptop computers. This work explored how virtualization influences the power consumption of both physical systems and virtual systems and which is the most efficient way to implement such applications. The main contribution to the project is the study on energy and thermal efficiency of virtualization solutions implemented on the two OS used today: Windows and Linux. In order to achieve this result the evaluation methodology and measurement setup have been proposed and implemented.

...

The full abstract at:

http://www.upt.ro/img/files/2015-2016/doctorat/abilitare/marcu/Abstract_Marcu.pdf

Habilitation Commission

Prof.univ.dr.ing. Liviu MICLEA
Universitatea Tehnică Cluj-Napoca;
Prof.univ.dr.ing. Sergiu NEDEVSCI
Universitatea Tehnică Cluj-Napoca;
Prof.univ.dr.ing. Horia CIOCĂRLIE
Universitatea Politehnica Timișoara;
Prof.univ.dr.ing. Victor PATRICIU
Academia Tehnică Militară.

RESEARCH-BASED MODELING, SIMULATION AND INTELLIGENT TECHNIQUES IN ELECTRICAL ENGINEERING

Author: Manuela PANOIU

Abstract

The habilitation thesis is divided into three parts. After a brief introduction, presented in chapter 1, Chapter 2 presents the results of the candidate research with specific references to publications. Chapter 3 presents a proposal for the development of the candidate future academic career.

Chapter 2 contains technical presentation of the research results and it is also structured into four parts. The first part contains an overview of the research activities after receiving by the candidate the PhD title. The second part of the technical presentation contains a presentation of the candidate research contributions in the field of modelling, simulation and control of some processes from electrical engineering. This area of research is a continuation of the research conducted by the candidate after obtaining her PhD degree. The candidate has studied the modelling of the electric arc in the arc furnace installation. The first paragraph presents some new electric arc models which candidate has studied. All simulations accomplished with these models are compared with experimental measurements. Based on these simulations, solutions for active power control and for positioning the electrodes were proposed. Many of the presented papers in this paragraph are the result of a project obtained after a competition, project on which the candidate was the project manager.

The third part of the technical presentation contains the candidate contribution in artificial intelligence field applied in Electrical Engineering. At the beginning, some of the results of modelling the electric arc using neural networks are presented, these being continuing her PhD research. Then, a neuro-fuzzy system used to predict the current in the electric arc is presented. This is followed by the presentation of some researches regarding the implementation of systems based on fuzzy logic using digital signal processors. In this part, the candidate contribution to the programming of signal processors in a system based on fuzzy logic, was presented, research implemented with the use of a TMS 320 series signal processor. There are two such systems to which the candidate has contributed, particularly to the fuzzy system programming. One of



the applications was implemented as a result of a research contract with an economic agent.

The fourth part summarizes some of the results obtained by the candidate as a member of a team that investigated the implementation of educational software systems. The team of which the candidate was member has implemented a series of practical educational systems that are used by the students as learning support. Those systems were implemented mostly in Java and can be included in an e-learning platform as a laboratory or course applications.

The last chapter, the third one, summarizes the candidate personal contributions and establishes a future development plan for the candidate.

The full abstract at:

http://www.upt.ro/img/files/2015-2016/doctorat/abilitare/panoiu/Abstract_teza_MPanoiu.pdf

Habilitation Commission

Prof.univ.dr.ing. Dumitru TOADER
Universitatea Politehnica Timișoara;
Prof.univ.dr.ing. Radu MUNTEANU
Universitatea Tehnică Cluj-Napoca;
Prof.univ.dr.ing. Vasile ȚOPA
Universitatea Tehnică Cluj-Napoca.

LAND RECLAMATION AND IMPROVEMENT WORKS AND SUSTAINABLE LAND MANAGEMENT IN THE CONTEXT OF CLIMATIC CHANGES

Author: Rareș HĂLBAC-COTOARĂ-ZAMFIR

Abstract

The present thesis includes the results of research activities conducted by the candidate after he sustained his PhD thesis in 2010, thesis having the following title „Technical and economical efficient drainage studies for fields with humidity excess”. This PhD thesis engaged a very important and actual research theme for land reclamation and improvement and environment protection domains being focused on the necessity of land drainage studies in the perspective of implementing a sustainable agriculture considering the necessity of conserving soil and water resources and the challenges generated by climatic changes.

Because drainage is a vital component of water resources integrated management, process which promotes the coordination of water, soil and other natural resources management and which relates with those for maximizing the economical and social sectors in an equitable manner and without compromising the sustainability of vital ecosystems, this work supposed an interdisciplinary research comprising problems connected with soil science, climatology, drainage, mathematics, informatics, modeling. For realizing some technical and economical efficient drainage studies, IT component become in the last years extremely important, modeling programs being those which can offer the best information referring to the evolution of ecosystem components and services provided by those ecosystems following the implementations of a land drainage system.

In a first stage, as a follow of previous activities conducted by the candidate for his PhD thesis, the candidate activity focused on issues referring to IT products used in land reclamation and improvement technique, especially in studying land drainage systems. Research activity was mainly dedicated to the study of using different software in land drainage systems design and operation, the study of head losses in conditions of using (or not) filtering materials. Strongly connected with the first stage are two other major themes of research covered by the candidate: Natural resources integrated management using technical measures from civil engineering domain and Sustainable development, climatology, climatic changes. Currently, worldwide there is an extraordinary pressure on farmers for



maximizing their social and economical benefits from their lands facing at the same time land degradation and desertification. Sustainable land management is the key answer for these challenges and represents land management through which human society strive to agricultural production living conditions and ecosystems improvement. For including irrigation and drainage arrangements in a natural resources integrated management there are necessary the establishing of a set of factors consisting in coordination and support measures dedicated to the final users.

The candidate also granted a special attention to drought study by analyzing some climatic indicators for monitoring climatic changes in western Romania.

All these studies were correlated with research conducted at international level on climate changes, climate changes effects and management measures practiced at local, regional, national and international levels.

The full abstract at:

http://www.upt.ro/img/files/2015-2016/doctorat/abilitare/halbac/Summary_habilitation_thesis_Halbac.pdf

Habilitation Commission

Prof.univ.dr.eng. Anton ANTON
Technical University of Civil Engineering of Bucharest;
Prof.univ.dr.eng. Ioan BICA
Technical University of Civil Engineering of Bucharest;
Prof.univ.dr. Sorin CĂMPEANU
University of Agronomic Sciences and Veterinary Medicine, Bucharest.

CONTRIBUTIONS TO IMPROVE THE STEEL QUALITY

Author: Ana Virginia SOCALICI

Abstract

The habilitation thesis is a summary of the scientific concerns and activities carried out after sustaining the PhD Thesis at Politehnica University of Timișoara.

The results of scientific work falls in the field of materials engineering, being approached the following research directions:

- Modern methods and technologies applied in steelmaking;
- Technologies used to recover the ferrous waste and scrap for greening the industrial environment.

The development of a solid research grounding in the field of materials engineering, supported by the teaching foundation of the modern technologies applied for materials making and processing, is a very topical issue in the contemporary society, and this could be primarily achieved through the professional and academic experience of the professors involved in this field.

The scientific work carried out led to the development of competencies in: technologies used for making and casting metal alloys, optimization of steel making and casting, modelling and simulation of steel solidification processes, application of greening technologies on bulk ferrous waste recovery and processing and interpretation of the research results. Given the results obtained so far, the research will continue in the areas of research presented above, this research being intended to complement the existing achievements and focusing on two strategic approaches, i.e. *education and research*.

Here is the summary of the strategies adopted to implement each objective: developing new research topics related to obtaining composite materials and advanced materials applicable in the industrial practice and development of new collaborations.



The full abstract at:

http://www.upt.ro/img/files/2015-2016/doctorat/abilitare/socalici/Rezumat_teza_en_A_Socalici.pdf

Habilitation Commission

Prof.Dr.Ing. Ioan VIDA-SIMITI
Universitatea Tehnică din Cluj-Napoca;
Prof.Dr.Ing. Cristian PREDESCU
Universitatea Politehnica din București;
Prof.Dr.Ing. Ion MITELEA
Universitatea Politehnica Timișoara.

ADVANCED MEASUREMENT, COMMAND, CONTROL AND PROTECTION EQUIPMENT FOR POWER SYSTEMS

Author: Flaviu Mihai FRIGURĂ - ILIASA

Abstract

The habilitation thesis is structured in three parts: the abstract, the technical presentation and the bibliographic references.

The habilitation thesis starts with an abstract that includes the synthesis of the habilitation thesis typed in English, as well as in Romanian language.

The second part of the thesis named „Technical Presentation” and includes ten sections.

In the first section are presented briefly the remarkable achievements obtained through research and educational activities (list with publications and grants classified on three research directions, new disciplines introduced in the education plans, taught courses, contributions brought to the development of the syllabus, invited professor, practice activities with students, conducting license and dissertation theses, endowed laboratories and library, international cooperation, management activities, etc.). It has to be mentioned that in the period of time 2001 - 2016 I've published a number of 83 scientific articles, I've participated in the frame of 14 research grants / contracts won through competition (at 5 of them I was project director) and I've elaborated 7 books in the fields connected to the present thesis.

The main research directions are:

A. Measurement, Command, Control and Automation Equipment;
B. Materials, Equipment, Methods and Work Techniques for Power Commutation;

C. Devices, Apparatus and Techniques for Power Systems Protection.
The second section presents the contributions adequate to all research directions. The most important scientific achievements are classified in 10 chapters, all three domains being mixed.

The first chapter is related to automation issues based on PLCs. This kind of particular embedded system is replacing traditional electric equipment based on relays and similar devices. Some applications, developed on the Low Voltage Apparatus Laboratory are presented as well.

The second chapter is describing some SCADA systems applied in district heating and power plant facilities. They are result of a project with COLTERM S.A. Timisoara and ELSACO Electronic S.R.L. Some of



these software applications are already in use at the Freidorf District Power Plant, in Timisoara or other similar companies.

The third part presents some issues about ferromagnetic forces in computational apparatus which are computed based on a new theory related to Maxwell's tensors. All theoretical aspects are verified by some practical measurements.

The fourth chapter presents some mathematical models applied in order to obtain an excellent interpolation of measured signals which are submitted to DSP's inside digital measurement systems. The B-Spline functions taken in consideration offer an excellent response, mostly to sinusoidal functions, belonging to standard power measurements. This response is certified by a set of experiments.

...

The full abstract at:

http://www.upt.ro/img/files/2015-2016/doctorat/abilitare/frigura/Rezumat_teza_ro_en_F_Frigura.pdf

Habilitation Commission

Prof.univ.dr.ing. Petru ANDEA
Universitatea Politehnica Timișoara;
Prof.univ.dr.ing. Adrian BADEA
Universitatea Politehnica din București;
Membru: Prof.univ.dr.ing. George DARIE
Universitatea Politehnica din București.

TOWARD NEW FRONTIERS FOR COMPOSITE MATERIALS

Author: Mircea NICOARĂ

Abstract

Scientific contributions that are presented follow the latest evolutions from the classic concept of composite material with light metallic matrix discontinuously reinforced with micron-sized particles, produced by mean of conventional casting or powder metallurgy techniques, toward new scientific frontiers.

In this respect, the 1st Chapter of the thesis synthesizes the scientific contributions for development of Ti-based composites with amorphous matrix and crystalline secondary phases for biomedical applications. The first direction is represented by the development of a new Ni-free titanium alloy with composite amorphous/crystalline structure, containing minor addition of Ga. The new $Ti_{41.5}Zr_{2.5}Hf_{1.5}Cu_{37.5}Ga_{7.5}Si_5Sn_5$ alloy fabricated by mean of suction casting method has a very complex structure of an amorphous/nano-crystalline composite. The second direction that was followed was represented by development of new Ti-based composites without any Cu-content, for applications as orthopedic implants, considering the well-established cytotoxic effect of this element, which was replaced with Ag. The newly designed alloy $Ti_{42}Zr_{10}Pd_{14}Ag_{26}Sn_8$ fabricated by ultra-rapid melt cooling shows a complex microcrystalline structure, with residual amorphous matrix. The new alloy has some promising features for use as biomaterial, considering the bactericidal effect of metallic Ag and the composite amorphous – crystalline character with potential for high mechanical properties.

The 2nd Chapter presents the scientific contributions that resulted in development of new porous materials, considered to be composite materials by some leading opinions. A new biomaterial with Ti-based amorphous matrix was fabricated using an advanced technique that combines melt-spinning of amorphous ribbons followed by powder metallurgy processing. Resulting $Ti_{42}Zr_{40}Ta_3Si_{15}$ amorphous material has some outstanding properties, having mechanical properties close to human bone.

New processing frontiers for fabrication of Al-based composites reinforced with ceramic particles are summarized in the 3rd Chapter. Researches in this field have been focused mainly on new hybrid Al-based composites produced by mean of innovative fabrication



methods. The new composites have two types of reinforcements, the first one is embedded alumina, while a second fraction of alumina particles is produced in-situ.

The 4th Chapter illustrates with examples the application of computerized image processing to the analysis of reinforcement distribution for some discontinuously reinforced aluminum matrix composites. This advanced investigation technique allows objective interpretation of microstructural images obtain by light or electronic microscopy, as well the use of statistical methods for characterization and optimization of particle distribution.

The scientific achievements in the field of materials science and engineering were published in prestigious journals with large impact on the research community, such as *Intermetallics*, *Acta Biomaterialia*, *Acta Materialia*, *Materials*, *Journal of Thermal Analysis and Calorimetry*, *Metal*, *Journal of Magnetism and Magnetic Materials*, or included in the proceedings of international conferences.

The full abstract at:

http://www.upt.ro/img/files/2015-2016/doctorat/abilitare/nicoara/Abstract_thesis_Mircea_Nicoara_EN.pdf

Habilitation Commission

Prof. Ionel CHICINAȘ
Technical University of Cluj-Napoca;
Prof. Corneliu MUNTEANU
Technical University "Gheorghe Asachi" of Iași;
Prof. Mircea JIEREAN
Transilvania University of Brașov.

TRANSLATION AND LANGUAGES PROBLEMATICS IN-BETWEEN THEORY, PRACTICE AND DIDACTICS

Author: Mirela-Cristina POP

Abstract

Written in French, according to the methodological dispositions effective in 2016, the habilitation thesis presents the *scientific*, *academic* and *professional* paths undertaken after 2007, the year of the doctoral thesis' defense, as well as the significant results achieved in the field of *Translation and Languages (French and Romanian as Foreign Languages)*. These objectives lead the two parts of the thesis that is structured into five chapters.

The first chapter outlines the *Scientific Path* followed into three directions of research: applied linguistics, translation studies, language teaching and learning. Research in applied linguistics has led us to sketch out the foundations of an enunciative approach to translation problems. The results achieved in translation studies were classified according to the addressed issues: theoretical, practical and didactic issues; ethical and deontological issues. The third direction – language teaching and learning – is based on our experience teaching French and Romanian as foreign languages and it pertains to the following aspects: a modular vision of language teaching and learning at university level, based on the concept of “progression of skills”; curriculum design, integration of new technologies, resource design.

The *Academic Path* is the outlined subject of the second chapter, dedicated to the presentation of the results achieved in the whole academic career: the evolution of didactic grades since 1995, the subjects taught, the didactic materials elaborated and a summary of the undertaken activities.

The third chapter entitled *Professional Path* outlines the results achieved in the professional career, especially the following: member of editorial and scientific committees, professional translation and interpretation activities, keynote speaker, session chair, expert evaluator in the field of applied modern languages, short-term expert, etc.

The fourth chapter frameworks the results obtained by the research groups that we have been directing since 2009 along the lines that led to the recognition of our scientific, academic and professional path: applied linguistics, translation studies, language teaching and learning.



The fifth chapter illustrates our academic concerns regarding the organization and management of didactic activities for professional and institutional purposes in the field of translation and languages (French and Romanian), as follows: member of thesis committees in the humanities (since 2013); management of translation memories (since 1996); organization of scientific and academic activities; academic functions (dean, vice-dean, faculty's quality manager, departmental quality manager, curriculum developer and director, etc.); activities dedicated to students. For activities carried out for the benefit of students, the Romanian National Association of Student Organizations (ANOSR) awarded us in 2010 the “Profesor Bologna” distinction.

As research perspectives, our intention is to carry on towards new directions the problematics described above with regards to translation and languages, taking into account the theoretical, practical and didactic approaches outlined in our *scientific*, *academic* and *professional* paths.

The full abstract at:

http://dev.doctorat.uvt.ro/wp-content/uploads/2015/12/10-Rezumato_RO_teza_de_abilitare_Pop_Mirela_Cristina.pdf

Habilitation Commission

Prof.univ.dr. Cristiana Nicola TEODORESCU

Universitatea din Craiova;

Prof.univ.dr. Georgiana LUNGU BADEA

Universitatea de Vest din Timișoara;

Prof.univ.dr. Liana POP

Universitatea “Babeș Bolyai” din Cluj Napoca.

TRANSLATION METHODS AND TRANSLATION PROCESSES: PAST, PRESENT AND FUTURE

Author: Daniel DEJICA-CARTIȘ

Abstract

The Habilitation thesis *Translation methods and translation processes: past, present and future* presents my didactic and scientific achievements related to the field of Translation Studies (TS). The three main parts of the thesis, divided into 12 chapters, focus on the period since the completion of doctoral studies (2009) to date, and present my vision on the development of translation studies in Romania and in the European area of research in the next period. The first part, *Investigating Translation Studies*, presents the early stages of my research activities and the structural-functional translation method that I developed in my PhD thesis. The next part details the ways in which I furthered my research in TS after my PhD defense. The research findings are grouped in source text analysis and understanding, transfer, reproduction and miscellaneous. This part of the thesis also includes a summary of the national and international research and development projects in TS in which I was involved. An important part of the thesis is also devoted to the editing and reviewing activities in TS in which I am involved. Two more chapters complete this part, namely teaching and applying TS. I detail the courses I have been developing in my teaching career and the translation projects I managed in the language industry. The last part of the thesis presents a series of research and didactic challenges in the field of TS and the ways in which I want to address these challenges and contribute thus to the development of this field in Romania. In an increasingly pragmatic society, in which the academia is also included, in a time in which we are witnessing the closure of translation and interpretation departments or the exclusion of certain humanities' disciplines in higher education, TS should redefine and reconsider its priorities, mainly as a support discipline with a defining role in promoting science in the knowledge society. In the era of technology, translation is and must remain an important object of study aimed at meeting the market requirements and challenges on performing a growing volume of quality translations in a shorter period of time. Some of the answers to these challenges can be generated in terms of research, by rethinking traditional translation processes and in terms of didactics, by updating the

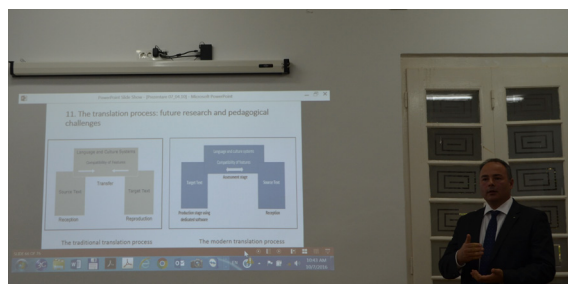

translation curricula and by introducing new disciplines, such translation assessment, computer-assisted translation, machine translation, management of translation projects and processes etc., all of these aspects being detailed in the final chapter of the thesis.

The full abstract at:

<http://dev.doctorat.uvt.ro/wp-content/uploads/2016/05/11-Rezumata-teza-abilitare.pdf>

Habilitation Commission

Prof. univ. dr. Daniela IONESCU
Universitatea din București;
Prof. univ. dr. Ștefan OLTEAN
Universitatea „Babeș-Bolyai” din Cluj-Napoca;
Prof. univ. dr. Hortensia PĂRLOG
Universitatea de Vest din Timișoara.

PhD THESIS

EVOLUTION OF PhD THESIS DEFENDED IN PUT 2012 - 2016

PhD students of PUT are those with a high degree of personal motivation that stems from their natural curiosity and love of intellectual pursuits. It is expected that after they obtain their degree they will metamorphose into scholars for whom also the temptation of researching new and exciting subjects is irresistible, or at least preferable to all other choices.

Doctoral programs usually encompass intensive training in research methods, including interviewing, surveys, questionnaires, clinical trials and laboratory experiments; later, those skills are put into practice when the doctoral candidate conducts fieldwork for his dissertation. Skills gained in qualitative and quantitative research methodology and statistical analysis are transferable to non-academic research environments, particularly for industrial research. In addition, employers outside of academia seek individuals with sound research skills to carry out projects at think tanks and research institutes in both the private and government sectors.

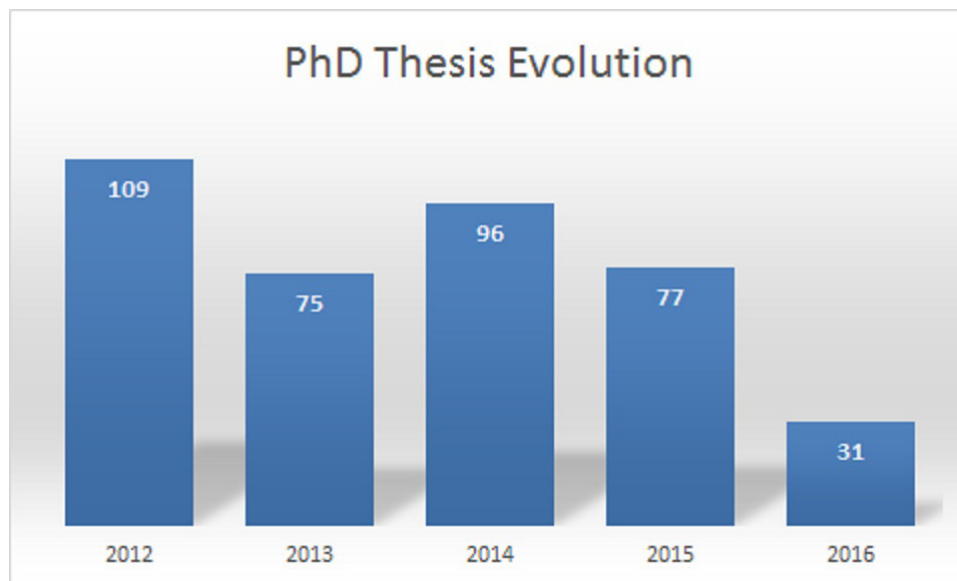

In this chapter we present a list of the PhD Thesis defended in Politehnica University of Timisoara during 2016.

Architecture

Diana GIUREA Supervisor prof. C. DUMITRESCU	<i>Porozitatea formelor arhitecturale organice</i> (The porosity of organic architectural forms)
Maja BĂLDEA Supervisor prof. C. DUMITRESCU	<i>Noi tipare de locuire multifamilială cu densitate ridicată</i> (New patterns of high-density multifamily housi)
Camil Octavian MILINCU Supervisor prof. C. DUMITRESCU	<i>Mobilier în a patra Revoluție Industrială</i> (Furniture design for the fourth industrial revolution)

Computers and Information Technology

Alexandru TOPÎRCEANU Supervisor prof. M. VLĂDUȚIU	<i>Analiza și modelarea structurală și comportamentală a societății</i> (Structural and behavioral analysis and modeling of the society)
Daniel-Alexandru JURCĂU Supervisor prof. V. STOICU-TIVADAR	<i>Contribuții privind arhitectura multi-nivel a sistemelor de înregistrări electronice de sănătate</i> (Contribution on the multi- tier architecture of electronic health record systems)
Nicolae Teodor MELIȚĂ Supervisor prof. Ș. HOLBAN	<i>Contribuții la analiza și prelucrarea datelor în analiza genetică</i> (Contributions to data analysis and processing in genetic analysis)
Maria Laura ȘEBU Supervisor prof. H. CIOCĂRLIE	<i>Soluție colaborativă multi-organizațională bazată pe modele de proces</i> (Business processes modeling solution supporting cross-organizatinal collaboration)
Sergiu NIMARĂ Supervisor prof. M. POPA	<i>Analiza impactului erorilor tranzitorii ale circuitelor CMOS subalimentate la multiple nivele de abstractizare ale unui sistem digital</i> (Transient errors impact analysis for sub - powered CMOS circuits at multiple levels of abstraction of a digital system)

Systems Engineering

Călin CÎRSTEA Supervisor prof. O. PROȘTEAN	<i>Contribuții la proiectarea și dezvoltarea unei platforme informatice dedicate sistemelor distribuite</i> (Contributions to the design and development of a distributed systems it platform)
Ana-Maria DAN Supervisor prof. T.L. DRAGOMIR	<i>Modelarea sistemului cardiovascular și sinteza mecanismelor de conducere pentru scenariul de exercițiu</i> (Modeling of the cardiovascular system and its control mechanisms for the exercise scenario)

Chemical Engineering

Roxana MUNTEAN Supervisor prof. N. VASZILCSIN	<i>Dezvoltarea unor materiale catalitice pe bază de nanofibre de carbon pentru aplicații în celulele electrochimice</i> (Materials based on carbon nanofibers for electrochemical cell applications)
---	---

Civil Engineering

Beniamin SÎNGEORZAN
Supervisor prof. M. MARIN

Contribuții aduse la evaluarea rezistenței și stabilității fundațiilor încastrate elastic în teren și a incidentelor de fundare
(Contributions to assessment the strength and stability of the elastic fixed foundation in the soil and of the foundation precincts)

Flaviu-Cristian LEONTIUC
Supervisor prof. V. STOIAN

Contribuții privind reabilitarea fațadelor clădirilor istorice în lumina standardelor de confort
(Contributions regarding the rehabilitation of facades of historical buildings in the light of standards of comfort)

Civil Engineering and Building Services

Georgiana RUSU
Supervisor prof. I. COSTESCU

Contribuții privind urmărirea în timp a deplasărilor și deformațiilor construcțiilor prin metode topogeodezice
(Contributions regarding displacement and deflection construction monitoring using topo-geodetic methods)

Adriana-Aurelia POP (SCURT)
Supervisor prof. C. BOB

Contribuții la aplicarea unor procedee eficiente de reabilitare structurală a clădirilor
(Contributions to the application of effective structural rehabilitation methods of building)

Electronic Engineering and Telecommunications

Andrei PAȘCA
Supervisor prof. M. CIUGUDEAN

Tehnici speciale în rețelele de distribuție de clock pe chip-uri
(Special technics in clock distribution networks on chips)

Vlad-Mircea MIHĂESCU
Supervisor prof. R. VASIU

Dezvoltarea și implementarea unui model de platformă MOOC din punct de vedere tehnic și educațional
(The development and implementation of a MOOC platform model from a technical and educational perspective)

Electrical Engineering

Laurentiu Constantin PADEANU
Supervisor prof. M. BIRIESCU

Contribuții la testarea și îmbunătățirea funcționării hidrogeneratoarelor sincrone verticale de putere mare folosind instrumentația virtuală
(Contributions on testing and improving the working conditions of large vertical synchronous hydro-generators by using virtual instrumentation)

Marcus-Ioan SVOBODA
Supervisor prof. M. BIRIESCU

Contribuții la studiul distribuției curenților din indusul motorului asincron trifazat cu colivie simetrică și nesimetrică
(Contribution on the study of rotor currents distribution of asynchronous three phase motor with symmetrical and asymmetrical cage)

Engineering and Management

Biagio DI FRANCO

Supervisor prof. M. IZVERCIAN

Contribuții la reducerea rezistenței consumatorului în prezența unui inovații de ruptură, prin marketing: aplicație vizând adoptarea de energii alternative prin introducerea pilei de combustie în domeniul transporturilor auto

(Contributions to reduce consumer resistance in the presence of a radical innovation through marketing: application aiming the adoption of alternative energies through the introduction of fuel cells in the sector of automobile transport)

Gabriel Cristian GRUBER

Supervisor prof. C.D. DUMITRESCU

Managementul sistemului de fabricare a componentelor de frânare pentru autoturisme

(The management of production systems components brake for cars)

Frank Martin RENNUNG

Supervisor prof. A. DRĂGHICI

Supervisor prof. G.G. SAVII

Managementul complexității proceselor de servicii. Cazul organizațiilor de afaceri mari

(Managing complexity in service processes. The case of large business organizations)

Andrei HUȚANU

Supervisor prof. G. PROȘTEAN

Considerații asupra modelelor de dezvoltare pentru proiectele software de radio-navigație

(Considerations on models used in the development of radio - navigation software projects)

Industrial Engineering

Ranko ZUHANEK

Supervisor prof. T. SLAVICI

Ingineria riscului în managementul sistemului sanitar din România

(Engineering risk of the health system in Romania)

Dorel BUNCIANU

Supervisor prof. M. JĂDĂNEANȚ

Influența proceselor industriale de fabricare a materialelor pe bază de caolin asupra proprietăților mecanice și electrice, în relație cu microstructura acestora

(Industrial manufacturing processes influence of kaolin based materials on mechanical and electrical properties, in relation to their microstructures)

Emilia Florina BINCHICIU

Supervisor prof. T. FLEȘER

Materiale cu precursori avansați și tehnologii de brazare

(Integrated brazing technologies with advance precursors)

Daniel TIUC

Supervisor prof. G. DRĂGHICI

Contribuții privind managementul calității proiectului în industria automotive

(Project quality management contributions in automotive industry)

Mechanical Engineering

Adrian POP

Supervisor prof. V. DOLGA

Contribuții privind optimizarea roboților industriali în aplicații de prelucrări mecanice

(Contributions in utilisation and optimisation of industrial robots, in machining applications)

Alin-Florin TOTOREAN

Supervisor prof. R. SUSAN-RESIGA

Curgerea în tuburi elicoidale. Aplicații medicale în intervențiile chirurgicale de tip bypass coronarian

(Fluid flow in helical tubes. Medical applications in coronary bypass surgery)

Bogdana Simina FULGA

Supervisor prof. A. DAVIDESCU

Sistem inline de control al calității pentru o fabricație auditivă sigură

(Inline quality control system for a reliable additive manufacturing)

Ioan LAZA

Supervisor prof. D. LELEA

Micro-sisteme de răcire cu nanofluid ca și fluid de lucru

(Microchannel heat sink with nanofluids)

SCIENTIFIC CONFERENCES

EVOLUTION OF SCIENTIFIC CONFERENCES 2012 - 2016

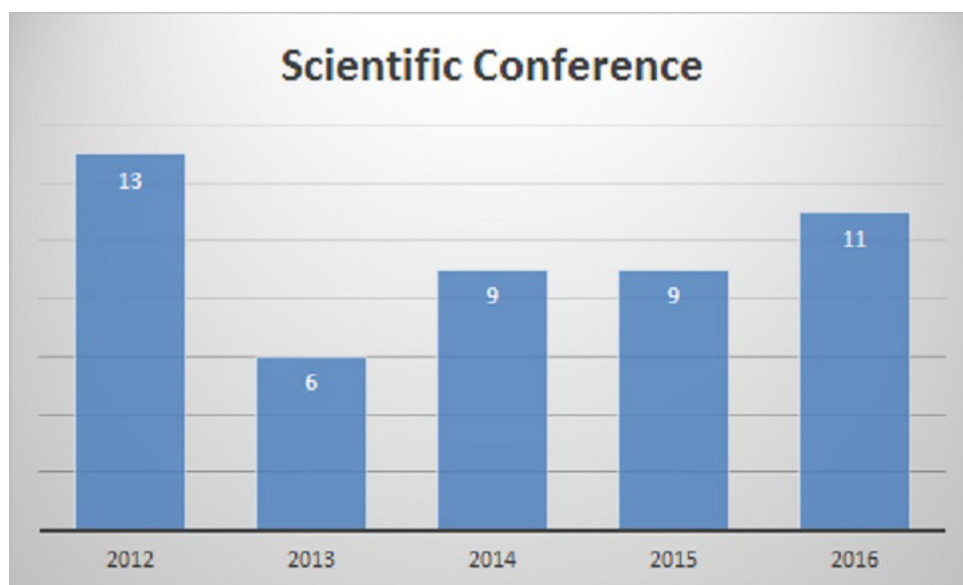



11th IEEE International Symposium on Applied Computational Intelligence and Informatics (SACI 2016)

12-14 May 2016, Timisoara, Romania

Organizers: Óbuda University, Budapest, Hungary

Politehnica University of Timisoara, Romania

IEEE Chapter of Systems, Man and Cybernetics Society, Romania

<http://conf.uni-obuda.hu/saci2016/>

SACI conference appears on the Australian Research Council list, in class C.

Topics:

- Computational Intelligence
- Intelligent Mechatronics
- Systems Engineering
- Intelligent Manufacturing Systems
- Intelligent Control
- Intelligent Robotics
- Informatics

Publication of papers

SACI 2016 papers are indexed in:

- Thomson Reuters Web of Science
- Scopus
- DBLP
- and other databases.



Smart Learning Ecosystems and Regional Development SLERD

19-20 May 2016, Timisoara, Romania

Organizers: Politehnica University of Timisoara, Multimedia Research Centre

Association for Smart Learning Ecosystems and Regional Development

<http://www.mifav.uniroma2.it/inevent/events/aslerd/index.php?s=232&link=slerd2016>

The 1st International Conference on Smart Learning Ecosystems and Regional Development intends to establish itself as an interdisciplinary forum where scholars, entrepreneurs and policy makers could bring and compare their visions, researches and experiences on how the “smartness” of the learning ecosystems (schools, campus, working places, informal learning contexts, etc.), sustained by the technologies, can influence the economical development, foster the social innovation and educate aware and active present and future citizens.



Management,
Knowledge and Learning
Joint International Conference 2016
Technology, Innovation
and Industrial Management

Joint International Conference of Management, Knowledge and Learning (MakeLearn) and Technology, Innovation and Industrial Management (TIIM)

25–27 May 2016, Timisoara, Romania

Organizer: Politehnica University of Timisoara, Faculty of Management in Production and Transportation

<http://makelearn.mfdps.si/index.php?id=97>

MakeLearn & TIIM 2016 conference theme focuses on Managing Innovation and Diversity in Knowledge Society through Turbulent Time. The conference deals with innovation as management's new imperative in finding novel solutions to important problems. Furthermore, contemporary workplace and markets are becoming more and more diverse. In order to survive, companies need to be able to manage and utilize its diverse workplace effectively. Managing diversity in the workplace should be a part of the culture of the entire organization. With this in mind, knowledge management can be the foundation in the search for the right answers and future directions in managing innovation and diversity in knowledge-based society. The conference proceedings is index in EconPaper (Idea) data base.

The conference proceedings is available at: <http://www.toknowpress.net/ISBN/978-961-6914-16-1/MakeLearn2016.pdf>

Dermol V., Trunk A., and Smrkolj M (Editors) (2016). MakeLearn 2016: Managing Innovation and Diversity in Knowledge Society Through Turbulent Time, Proceedings of the MakeLearn and TIIM Joint International Conference, 25–27 May 2016, Timisoara, Romania, ISSN 2232-3309, Published by ToKnowPress Bangkok • Celje • Lublin

ToKnowPress is a joint imprint of Kasetsart University, Thailand; International School for Social and Business Studies, Slovenia; and Maria Curie-Skłodowska University, Poland. Among others, ToKnowPress publishing house publishes conference proceedings of MakeLearn and TIIM conferences. ToKnowPress website: <http://www.toknowpress.net/>.



International Conference on Applied Sciences - ICAS2016

25–27 May 2015, Hunedoara, Romania

Organizer: Politehnica University of Timisoara

in cooperation with: Military Economics Academy of Wuhan, "Henri Coanda" Air Force Academy of Brasov, Academy of Romanian Scientists, Academy of Technical Sciences of Romania - Timisoara Branch, General Association of Romanian Engineers - Hunedoara Branch

<http://www.fih.upt.ro/v4/ICAS2016/index.htm>

Topics of the conference covers a comprehensive spectrum of issues from:

1. *Fundamental Sciences:* Numerical approximation and analysis, Interdisciplinary applications of mathematics and physics, Modelling and Simulation, and others...
2. *Materials Science:* Metallic Materials, Composite Materials, Metal Alloys, Metallurgy, Heat Transfer, Mechanical Engineering, Mechatronics, Reliability, and others...
3. *Electrical Engineering:* Circuits and Systems, Signal Processing, Computational Methods in Engineering, Software Engineering, Data Bases, and others...

Publication of papers:

- Proceedings of ICAS2016: published in *IOP Conference Series: Materials Science and Engineering vol. 163* (2017)
- Proceedings of ICAS2015: published in *IOP Conference Series: Materials Science and Engineering vol. 106* (2016), indexed by Thomson Reuters - Web of Sciences and Scopus
- Proceedings of ICAS2014: published in *IOP Conference Series: Materials Science and Engineering vol. 85* (2015), indexed by Thomson Reuters - Web of Sciences and Scopus
- Proceedings of ICAS2013: published in *IOP Conference Series: Materials Science and Engineering vol. 57* (2014), indexed by Thomson Reuters - Web of Sciences and Scopus .



The International Colloquium on Stability and Ductility of Steel Structures – SDSS 2016

30 May - 01 June, 2016, Timisoara, Romania

Organizer: Politehnica University Timișoara, Department of Steel Structures and Structural Mechanics

<http://www.ct.upt.ro/sdss2016/>

The 2016 edition of SDSS is jointly organized by the Politehnica University of Timisoara, Department of Steel Structures and Structural Mechanics in co-operation with the Romanian Academy - Timisoara Branch, with the support of the European Convention of Constructional Steelwork (ECCS), through the Structural Stability Technical Committee (TC8), and the Structural Stability Research Council (SSRC, USA).

Since the revision of structural Eurocodes has been already started in Europe, and both stability and ductility of steel structures issues are on the desk of the drafters, this event enables the exchange of knowledge and experience in the field and the debate around the best solutions offered, and is therefore a useful opportunity for all the participants.

270 authors from 26 countries on 5 continents are contributing with 115 scientific papers and 4 Keynote Lectures, covering 9 topics, i.e.

1. Advanced structural design;
2. Connections;
3. Lightweight steel constructions;
4. Members' behaviour: tension, compression, beams, beam-columns;

5. Plate, shell and space structures;
6. Robustness;
7. Seismic-resistant structures;
8. Steel-concrete composite members and structures;
9. Tubular constructions.

The Proceedings edited by Dan DUBINA and Viorel UNGUREANU, containing 1006 pages, have been published by CMM – Associação Portuguesa de Construção Metálica e Mista and Ernst and Sohn and Wiley Company. The Proceedings was available to all registered participants at the Conference.



Innovative Technologies for Joining Advanced Materials – TIMA 2016

2-3 June 2016, Timisoara, Romania

Organizers: National R&D Institute for Welding and Material Testing - ISIM Timisoara
Politehnica University of Timisoara, Department of Materials and Manufacturing Engineering
Romanian Academy for Technical Sciences - Timisoara Subsidiary

<http://isim.ro/tima/index.htm>

Conference aims to provide a platform for useful interaction on actual problems in the field of joining and testing procedures of advanced materials.

Topics:

- New joining technologies
- Coatings: advanced materials & innovative technologies
- Modelling and simulation of welding and allied processes
- Specific problems in advanced materials joining
- Quality of welded joints and welded structures.

Publication of papers

<http://www.scientific.net/AMR>



MTM & Robotics 2016



MTM & Robotics 2016

The Joint International Conference of the XII International Conference on Mechanisms and Mechanical Transmissions (MTM) and the XXIII International Conference on Robotics (Robotics'16)

26-27 October 2016, Aachen, Germany

Organizers: RWTH Aachen University, Department of Mechanism Theory and Dynamics of Machines
Politehnica University of Timișoara, Department of Mechatronics

<http://www.mtm-robotics-2016.igm.rwth-aachen.de/index.php?id=start>

- MTM & Robotics is currently an international joint conference, which reunited and brought to international level two Romanian conferences: MTM and Robotics. MTM, the Romanian acronym for Mechanisms and Mechanical Transmissions is the name of a traditional conference, organized each four years since 1972 by the Mechatronics Department (former Machine elements and mechanisms chair) within the University Politehnica of Timișoara. The last joint conference MTM & Robotics 2016 was organized by the University RWTH Aachen, Germany in partnership with the University Politehnica of Timișoara, Romania and held at RWTH Aachen. The event was supported by IFToMM Germany, the Romanian Association for Theory of Machines and Mechanisms and the Robotics Society of Romania.
- The scientific committee, consisting of prestigious personalities from all over the world, accepted 48 contributions from more than 150 authors from 12 countries in Europe, America and Asia. The scientific contributions were printed at Springer Publishers, as a volume in the prestigious series Mechanisms and Machine Science (<http://www.springer.com/gp/book/9783319454498>).



ISETC'16

The 12th International Symposium on Electronics and Telecommunications (ISETC16)

27-28 October 2016, Timișoara, Romania

Organizer: Politehnica University of Timișoara, Faculty of Electronics and Telecommunications

<http://conference.etc.upt.ro/isetc2016/>

ISETC 2016 will bring together members from academia and industry to present their achievements in electronics and telecommunications. The symposium is organized by the Faculty of Electronics and Telecommunications (Politehnica University Timișoara) and the Association of Electrical Engineers from Timișoara;

Topics:

Communications – Applications – 8 papers
 Communications – Software – 6 papers
 Communications – Networks – 6 papers
 Signal processing – New Implementation – 5 papers
 Automotive – Modeling simulation and testing – 8 papers
 Electronic Circuits – 8 papers
 Computational Intelligence, Power Electronics and Robotics – 10 papers
 Signal processing – Innovative ideas – 6 papers
 Modern Satellite Image Processing Methods – 5 papers
 3D Image Processing – 7 papers
 Educations – New Challenges in engineering education – 9 papers

Published papers by:

- IEEE Xplore
- ISI WEB of Knowledge
- Proceedings of 12th International Symposium on Electronics and Telecommunications



The 25th International Conference NOISE AND VIBRATION - 25 ICNV

27-29 October 2016, Niš, Serbia

Co-organizers: University of Niš, Faculty of Occupational Safety and Acoustics

Politehnica University of Timisoara, Vibration Laboratory

<http://www.znrfak.ni.ac.rs/SERBIAN/021-KONFERENCIJE/NOISE%202016/Index.html>

- The main objective of this Conference is to provide an international forum for advanced scientific knowledge on noise and vibration.
- The conference is organised under the auspices of the Ministry of Education and Science of the Republic of Serbia.

Major topics of interest:

- Noise generation and propagation
- Vibration generation & propagation
- Vibration control
- Noise control
- Environmental noise
- Effect of noise and vibrations
- Analysis of noise and vibration

SCIENTIFIC JOURNALS



Transactions on Automatic Control and Computer Science Volume 61 (75), Issue 1, 2016

<http://www.ac.upt.ro/journal/>

- The history of this Journal of the Politehnica University of Timisoara is strongly related to its creation under the name Polytechnic School of Timisoara (Ecole Polytechnique de Timisoara).
- The journal is dedicated to publishing original theoretical and applicative research results and overviews on the current Research status in Automation, Computer Science and Applied Informatics.
- Transactions on Automatic Control and Computer Science is indexed by: Index COPERNICUS (Journals Master List), VINITI (All-Russian Institute of Scientific and Technical Information), (CNCSIS B+ journal).



Transactions on Hydrotechnics Volume 61 (75), Issue 1, Issue 2, 2016

<http://www.ct.upt.ro/buletinhidro/index.htm>

- The Scientific Bulletin of the Politehnica University of Timisoara, Transactions on Hydrotechnics is coordinated since 1992 by the Faculty of Hydrotechnical Engineering. Published papers in the journal focus on engineering sciences, civil engineering, theoretical and applied hydraulic, mathematics and numerical modeling, hydrology and water management, hydrotechnical developments and constructions, land improvement (irrigations, drainage, erosion control), engineering and sustainable rural development, water supply and sewerage systems, wastewater treatment, hydraulic structures and technologies.
- The Journal is published entirely in English, with abstracts and keywords, with international exposure.
- The revue is known for experts from home and abroad, is included in the database (Viniti, Russia) and international catalogs (SUWECO, Czech Republic). The Bulletin is broadcast in 26 foreign institutions and foreign publications received in exchange are in number of 19.

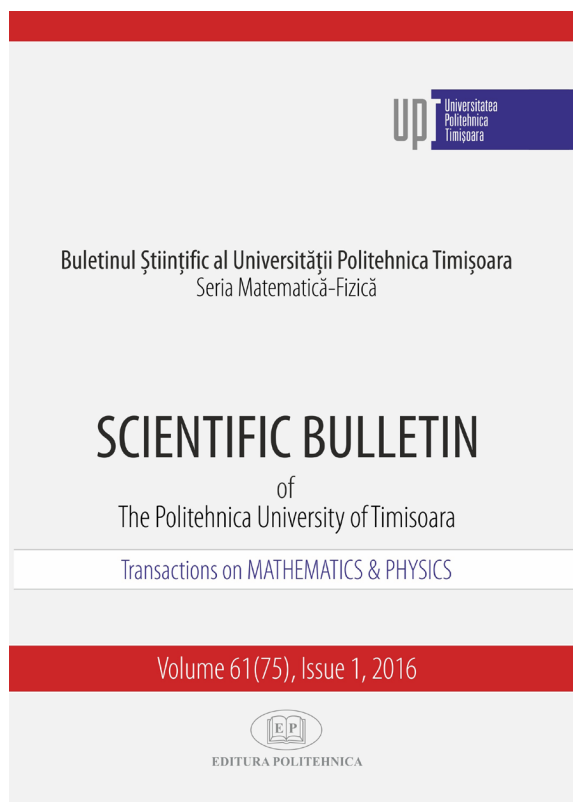

Transactions on Mathematics and Physics Volume 61 (75), Issue 1, Issue 2 , 2016

http://www.upt.ro/cercetare/mate_fizica.php

- The journal "Bulletin Scientifique de l'Ecole Polytechnique de Timisoara" was founded in 1923, when the head of the Polytechnical School of Timișoara was mathematicians Victor Vâlcovici (1885-1970).
- The first two issues appeared in 1925, respectively in 1926. In the first years, the journal has been contained mostly the mathematical articles (the authors being some famous national and foreign mathematicians as well V. Alaci, G. Alexich, M. Ghermănescu, D. Pompeiu, Ch. Brunold, G. Bouligand). This fact confer to actual journal "Transactions on Mathematics and Physics" of the Scientific Bulletin of "Politehnica" University of Timisoara, Romania the justification to realize the continuity of the old "Bulletin Scientifique".
- The **Transactions on Mathematics and Physics** is indexed CNCIS , B+.

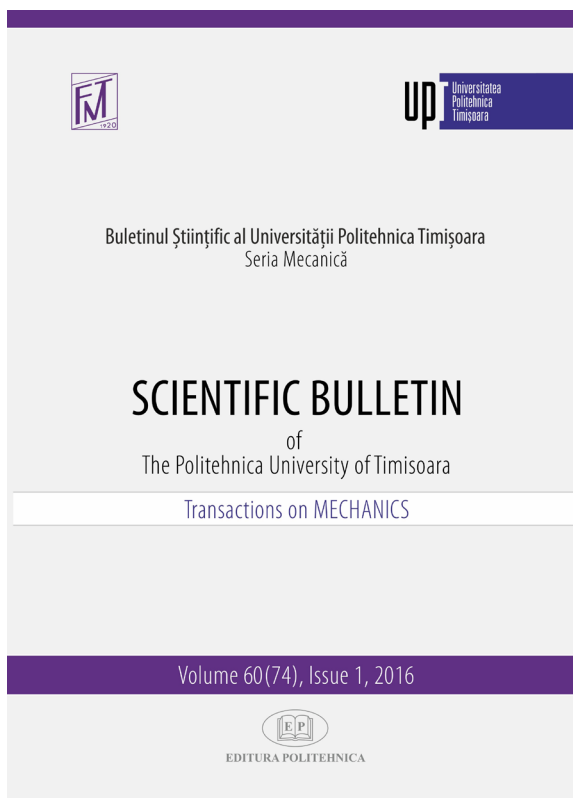

Transactions on Mechanics Volume 60 (74), Issue 1, Issue 2 , 2016

<http://www.eng.upt.ro/buletin/profile.html>

- The journal is dedicated to publishing original theoretical and applicative research results and overviews on the current research status in Applied Mechanics And Vibration, Resistance Of Materials, Termotechnical, Thermal Machine And Road Vehicles, Fluid Mechanics And Hydraulic Machinery, Machine Elements And Mechanisms, Mechatronics, Manufacturing Technology, Machine Tools, Materials Sciences And Heat Trataments, Equipment And Welding Technology, Industrial Engineering.
- The **Transactions on Mechanics** is indexed CNCIS , B+.



Transactions on Modern Languages Volume 15, Issue 1, 2016

<http://www.cls.upt.ro/publicatii/buletinul-stiintific>

- The Transactions on Modern languages, published by the Department of Communication and Foreign Languages, has its origin in The Social Science and Humanities Series, started in 1991 under ISSN 1223-1959.
- The Transactions of Modern Languages publishes original papers in all areas of theoretical and applied linguistics: Linguistics, Translation and Interpreting Studies, Discourse Analysis, Pragmatics, Rhetoric, Terminology, LSP, Foreign Language Teaching.
- The journal is included in the CEEOL, Fabula and EBSCO data bases.



Annals of Faculty Engineering Hunedoara International Journal of Engineering Volume 14, Issue 1, Issue 2 , 2016

<http://annals.fih.upt.ro/>

- The Journal is a multi-disciplinary journal which covers all aspects of scientific, engineering and technical disciplines including applications of scientific inventions for engineering, technological and industrial purposes, advances in engineering, technology and science.
- The Journal is accredited and ranked in the B+ category by The National University Research Council's Classification of Romanian Journals, CNCIS, and is indexed by Index Copernicus, Google Scholar, EBSCO Publishing, DOAJ, SCIRUS, EVISA, ProQuest, DRJI, CAS, BASE, etc.

ISI PAPERS

EVOLUTION OF ISI PAPERS UNDER AFFILIATIONS OF PUT 2012 - 2016

Scientific writing and publication marks the endpoint of research that has been performed, completed, peer reviewed and accepted, and complements teaching and training.

In this chapter we present the publications/papers written by our professors, PhD students, researchers etc. These publications can be: papers published in ISI Journals or papers presented at Conference and indexed in ISI Proceedings.

The number of papers presented in the below figures is greater than the number of papers presented in previous Research Reports. This number varies from year to year because annually it increases the number of publications indexed in the ISI Thompson Reuters database.

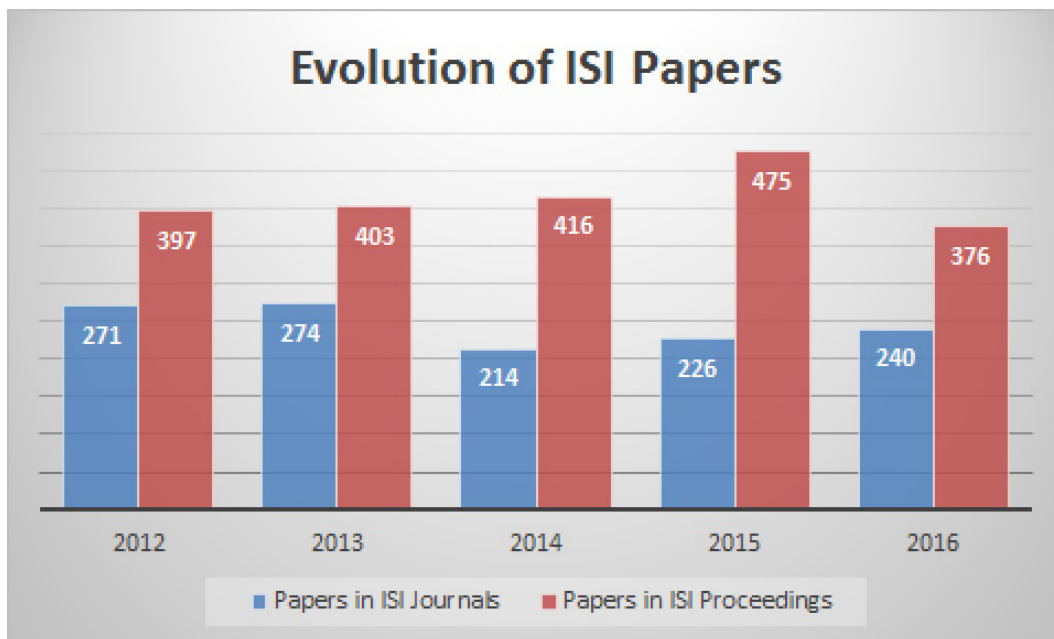
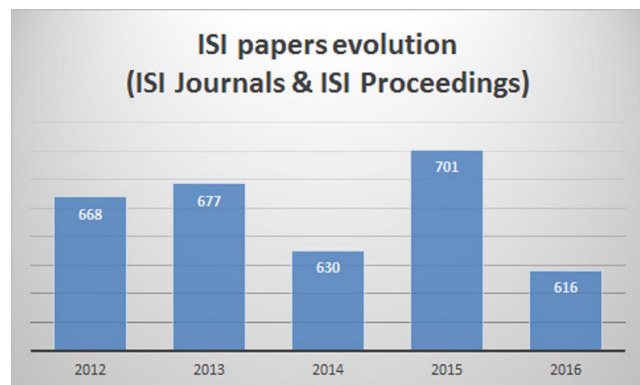

* The data was obtained from Thomson Reuters - Web of Science during February - April 2017

ISI Papers in highlight

No.	Article	Impact Factor / Quartile in Category
1.	Abdullah, A.D., Gisen, J.I.A., van der Zaag, P., Savenije, H.H.G., Karim, U.F.A., Masih, I., Popescu, I. Predicting the salt water intrusion in the Shatt al-Arab estuary using an analytical approach, <i>HYDROLOGY AND EARTH SYSTEM SCIENCES</i> , Volume: 20, Issue: 10, Pages: 4031-4042, ISSN: 1027-5606, eISSN: 1607-7938, 2016;	3.99 / Q1
2.	Ardit, M., Borcanescu, S., Cruciani, G., Dondi, M., Lazau, I., Pacurariu, C., Zanelli, C. Ni-Ti Codoped Hiconite Ceramic Pigments by Combustion Synthesis: Crystal Structure and Optical Properties, <i>JOURNAL OF THE AMERICAN CERAMIC SOCIETY</i> , Volume: 99, Issue: 5, Pages: 1749-1760, ISSN: 0002-7820, eISSN: 1551-2916, 2016;	2.787 / Q1
3.	Beevers, L., Popescu, I., Pan, Q., Pender, D. Applicability of a coastal morphodynamic model for fluvial environments, <i>ENVIRONMENTAL MODELLING & SOFTWARE</i> , Volume: 80, Pages: 83-99, ISSN: 1364-8152, eISSN: 1873-6726, 2016;	4.207 / Q1
4.	Belega, D., Petri, D., Dallet, D. Impact of harmonics on the interpolated DFT frequency estimator, <i>MECHANICAL SYSTEMS AND SIGNAL PROCESSING</i> , Volume: 66-67, Pages: 349-360, ISSN: 0888-3270, 2016;	2.771 / Q1
5.	Binzar, T., Pater, F., Nadaban, S. On fuzzy normed algebras, <i>JOURNAL OF NONLINEAR SCIENCES AND APPLICATIONS</i> , Volume: 9, Issue: 9, Pages: 5488-5496, ISSN: 2008-1898, eISSN: 2008-1901, 2016;	1.176 / Q1
6.	Bistriean, D.A., Susan-Resiga, R.F. Weighted proper orthogonal decomposition of the swirling flow exiting the hydraulic turbine runner, <i>APPLIED MATHEMATICAL MODELLING</i> , Volume: 40, Issue: 5-6, Pages: 4057-4078, ISSN: 0307-904X, eISSN: 1872-8480, 2016;	2.291 / Q1
7.	Boboescu, I.Z., Gherman, V.D., Lakatos, G., Pap, B., Biro, T., Maroti, G. Surpassing the current limitations of bio-hydrogen production systems: The case for a novel hybrid approach, <i>BIORESOURCE TECHNOLOGY</i> , Volume: 204, Pages: 192-201, PubMed ID: 26790867, ISSN: 0960-8524, eISSN: 1873-2976, 2016;	4.917 / Q1
8.	Brzdek, J., Cadariu, L. Stability for a family of equations generalizing the equation of p-Wright affine functions, <i>APPLIED MATHEMATICS AND COMPUTATION</i> , Volume: 276, Pages: 158-171, ISSN: 0096-3003, eISSN: 1873-5649, 2016;	1.345 / Q1
9.	Bunia, I., Socoliuc, V., Vekas, L., Doroftei, F., Varganici, C., Coroaba, A., Simionescu, B.C., Mihai, M. Superparamagnetic Composites Based on Ionic Resin Beads/CaCO ₃ /Magnetite, <i>CHEMISTRY-A EUROPEAN JOURNAL</i> , Volume: 22, Issue: 50, Pages: 18036-18044, PubMed ID: 27805763, ISSN: 0947-6539, eISSN: 1521-3765, 2016;	5.771 / Q1
10.	Camacho, O.M.F., Mihet-Popa, L. Fast Charging and Smart Charging Tests for Electric Vehicles Batteries Using Renewable Energy, <i>OIL & GAS SCIENCE AND TECHNOLOGY-REVUE D IFP ENERGIES NOUVELLES</i> , Volume: 71, Issue: 1, Article Number: 13, ISSN: 1294-4475, eISSN: 1953-8189, 2016;	1.087 / Q1
11.	Cindea, L., Hatiegan, C., Pop, N., Negrea, R., Raduca, E., Gillich, G.R., Danut, M., Nedeloni, M.D. The influence of thermal field in the electric arc welding of X60 carbon steel components in the CO ₂ environment, <i>APPLIED THERMAL ENGINEERING</i> , Volume: 103, Pages: 1164-1175, ISSN: 1359-4311, 2016;	3.043 / Q1
12.	Cires, I., Nani, V.-M. Stability control for a huge excavator for surface excavation, <i>APPLIED MATHEMATICAL MODELLING</i> Volume: 40, Issue: 1, Pages: 388-397, ISSN: 0307-904X, eISSN: 1872-8480, 2016;	2.291 / Q1
13.	Cogliati, A., Canavesi, C., Hayes, A., Tankam, P., Duma, V.F., Santhanam, A., Thompson, K.P., Rolland, J.P. MEMS-based handheld scanning probe with pre-shaped input signals for distortion-free images in Gabor-domain optical coherence microscopy, <i>OPTICS EXPRESS</i> , Volume: 24, Issue: 12, Pages: 13365-13374, PubMed ID: 27410354, ISSN: 1094-4087, 2016;	3.148 / Q1
14.	Craciunescu, C., Ercuta, A. Shape memory microactuation design by substrate's reinforcement layers, <i>MATERIALS & DESIGN</i> , Volume: 96, Pages: 364-369, ISSN: 0261-3069, eISSN: 1873-4197, 2016;	3.997 / Q1

No.	Article	Impact Factor / Quartile in Category
15.	Curiac, D.I. Towards wireless sensor, actuator and robot networks: Conceptual framework, challenges and perspectives, JOURNAL OF NETWORK AND COMPUTER APPLICATIONS, Volume: 63, Pages: 14-23, ISSN: 1084-8045, 2016;	2.331 / Q1
16.	Curiac, D.I. Wireless Sensor Network Security Enhancement Using Directional Antennas: State of the Art and Research Challenges, SENSORS, Volume: 16, Issue: 4, Article Number: 488, ISSN: 1424-8220, 2016;	2.033 / Q1
17.	Dinu, F., Marginean, I., Dubina, D., Petran, I. Experimental testing and numerical analysis of 3D steel frame system under column loss, ENGINEERING STRUCTURES, Volume: 113, Pages: 59-70, ISSN: 0141-0296, eISSN: 1873-7323, 2016;	1.893 / Q1
18.	Ene, R.D., Marinca, V., Marinca, B. Analytic Approximate Solutions to the Boundary Layer Flow Equation over a Stretching Wall with Partial Slip at the Boundary, PLOS ONE, Volume: 11, Issue: 3, Article Number: e0149334, ISSN: 1932-6203, 2016;	3.057 / Q1
19.	Epee, M.D.E., Mezei, J.Z., Motapon, O., Pop, N., Schneider, I.F. Reactive collisions of very low-energy electrons with H-2(+): rotational transitions and dissociative recombination, MONTHLY NOTICES OF THE ROYAL ASTRONOMICAL SOCIETY, Volume: 455, Issue: 1, Pages: 276-281, ISSN: 0035-8711, eISSN: 1365-2966, 2016;	4.952 / Q1
20.	Fagadar-Cosma, E., Sebarchievici, I., Lascu, A., Creanga, I., Palade, A., Birdeanu, M., Taranu, B., Fagadar-Cosma, G. Optical and electrochemical behavior of new nano-sized complexes based on gold-colloid and Co-porphyrin derivative in the presence of H2O2, JOURNAL OF ALLOYS AND COMPOUNDS, Volume: 686, Pages: 896-904, ISSN: 0925-8388, eISSN: 1873-4669, 2016;	3.014 / Q1
21.	Filip, I., Szeidert, I. Adaptive fuzzy PI controller with shifted control singletons, EXPERT SYSTEMS WITH APPLICATIONS, Volume: 54, Pages: 1-12, ISSN: 0957-4174, eISSN: 1873-6793, 2016;	2.981 / Q1
22.	Gheju, M., Balcu, I., Mosoarca, G. Removal of Cr(VI) from aqueous solutions by adsorption on MnO2, JOURNAL OF HAZARDOUS MATERIALS, Volume: 310, Pages: 270-277, ISSN: 0304-3894, eISSN: 1873-3336, 2016;	4.836 / Q1
23.	Gheju, M., Balcu, I., Vancea, C. An investigation of Cr(VI) removal with metallic iron in the co presence of sand and/or MnO2, JOURNAL OF ENVIRONMENTAL MANAGEMENT, Volume: 170, Pages: 145-151, ISSN: 0301-4797, eISSN: 1095-8630, 2016;	3.131 / Q1
24.	Hadaruga, D.I., Costescu, C.I., Corpas, L., Hadaruga, N.G., Isengard, H.D. Differentiation of rye and wheat flour as well as mixtures by using the kinetics of Karl Fischer water titration, FOOD CHEMISTRY, Volume: 195, Pages: 49-55, ISSN: 0308-8146, eISSN: 1873-7072, 2016;	4.052 / Q1
25.	Ianos, R., Istratie, R., Pacurariu, C., Lazau, R. Solution combustion synthesis of strontium aluminate, SrAl2O4, powders: single-fuel versus fuel-mixture approach, PHYSICAL CHEMISTRY CHEMICAL PHYSICS, Volume: 18, Issue: 2, Pages: 1150-1157, ISSN: 1463-9076, eISSN: 1463-9084, 2016;	4.449 / Q1
26.	Ioan, A., Stratan, A., Dubina, D., Poljansek, M., Molina, F.J., Taucer, F., Pegon, P., Sabau, G. Experimental validation of re-centring capability of eccentrically braced frames with removable links, ENGINEERING STRUCTURES, Volume: 113, Pages: 335-346, ISSN: 0141-0296, eISSN: 1873-7323, 2016;	1.893 / Q1
27.	Jung, H.Y., Stoica, M., Yi, S., Kim, D.H., Eckert, J. Preparation of cast-iron-based nanocrystalline alloy with Cu and Nb addition, INTERMETALLICS, Volume: 69, Pages: 54-61, ISSN: 0966-9795, eISSN: 1879-0216, 2016;	2.541 / Q1
28.	Kalluf, F.J.H., Isfanuti, A.S., Tutelea, L.N., Moldovan-Popa, A., Boldea, I. 1-kW 2000-4500 r/min Ferrite PMSM Drive: Comprehensive Characterization and Two Sensorless Control Options, IEEE TRANSACTIONS ON INDUSTRY APPLICATIONS, Volume: 52, Issue: 5, Pages: 3980-3989, ISSN: 0093-9994, eISSN: 1939-9367, 2016;	1.901 / Q1

No.	Article	Impact Factor / Quartile in Category
29.	Ledeti, I., Ledeti, A., Vlase, G., Vlase, T., Matusz, P., Bercean, V., Suta, L.M., Piciu, D. Thermal stability of synthetic thyroid hormone L-thyroxine and L-thyroxine sodium salt hydrate both pure and in pharmaceutical formulations, <i>JOURNAL OF PHARMACEUTICAL AND BIOMEDICAL ANALYSIS</i> , Volume: 125, Pages: 33-40, PubMed ID: 26999320, ISSN: 0731-7085, eISSN: 1873-264X, 2016;	3.169 / Q1
30.	Malaescu, I., Lungu, A., Marin, C.N., Vlazan, P., Sfirloaga, P., Turi, G.M. Experimental investigations of the structural transformations induced by the heat treatment in manganese ferrite synthesized by ultrasonic assisted coprecipitation method, <i>CERAMICS INTERNATIONAL</i> , Volume: 42, Issue: 15, Pages: 16744-16748, ISSN: 0272-8842, eISSN: 1873-3956, 2016;	2.758 / Q1
31.	Marsavina, L., Constantinescu, D.M., Linul, E., Stuparu, F.A., Apostol, D.A. Experimental and numerical crack paths in PUR foams, <i>ENGINEERING FRACTURE MECHANICS</i> , Volume: 167, Special Issue: S, Pages: 68-83, ISSN: 0013-7944, eISSN: 1873-7315, 2016;	2.024 / Q1
32.	Marsavina, L., Kovacic, J., Linul, E. Experimental validation of micromechanical models for brittle aluminium alloy foam, <i>THEORETICAL AND APPLIED FRACTURE MECHANICS</i> , Volume: 83, Pages: 11-18, ISSN: 0167-8442, eISSN: 1872-7638, 2016;	2.025 / Q1
33.	Mezei, J.Z., Colboc, F., Pop, N., Ilie, S., Chakrabarti, K., Niyonzima, S., Lepers, M., Bultel, A., Dulieu, O., Motapon, O., Tennyson, J., Hassouni, K., Schneider, I.F. Dissociative recombination and vibrational excitation of BF ⁺ in low energy electron collisions, <i>PLASMA SOURCES SCIENCE & TECHNOLOGY</i> , Volume: 25, Issue: 5, Article Number: 055022, ISSN: 0963-0252, eISSN: 1361-6595, 2016;	2.808 / Q1
34.	Mitelea, I., Oanca, O., Bordeasu, I., Craciunescu, C.M. Cavitation Erosion of Cermet-Coated Aluminium Bronzes, <i>MATERIALS</i> , Volume: 9, Issue: 3, Article Number: 204, ISSN: 1996-1944, 2016;	2.728 / Q1
35.	Modler, N., Winkler, A., Filippatos, A., Lovasz, E.C., Margineanu, D. Simulation and experimental investigation of active lightweight compliant mechanisms with integrated piezoceramic actuators, <i>SMART MATERIALS AND STRUCTURES</i> , Volume: 25, Issue: 8, Article Number: 085047, ISSN: 0964-1726, eISSN: 1361-665X, 2016;	2.769 / Q1
36.	Molcan, M., Gojzewski, H., Skumiel, A., Dutz, S., Kovac, J., Kubovcikova, M., Kopcansky, P., Vekas, L., Timko, M. Energy losses in mechanically modified bacterial magnetosomes, <i>JOURNAL OF PHYSICS D-APPLIED PHYSICS</i> , Volume: 49, Issue: 36, Article Number: 365002, ISSN: 0022-3727, eISSN: 1361-6463, 2016;	2.772 / Q1
37.	Montiel, J., Szucs, A., Boboescu, I.Z., Gherman, V.D., Kondoros, E., Kereszt, A. Terminal Bacteroid Differentiation Is Associated With Variable Morphological Changes in Legume Species Belonging to the Inverted Repeat-Lacking Clade, <i>MOLECULAR PLANT-MICROBE INTERACTIONS</i> , Volume: 29, Issue: 3, Pages: 210-219, PubMed ID: 26713350, ISSN: 0894-0282, eISSN: 1943-7706, 2016;	4.145 / Q1
38.	Motoc, S., Manea, F., Iacob, A., Martinez-Joaristi, A., Gascon, J., Pop, A., Schoonman, J. Electrochemical Selective and Simultaneous Detection of Diclofenac and Ibuprofen in Aqueous Solution Using HKUST-1 Metal-Organic Framework-Carbon Nanofiber Composite Electrode, <i>SENSORS</i> , Volume: 16, Issue: 10, Article Number: 1719, ISSN: 1424-8220, 2016;	2.033 / Q1
39.	Negru, R., Serban, D.A., Marsavina, L., Magda, A. Lifetime prediction in medium-cycle fatigue regime of notched specimens, <i>THEORETICAL AND APPLIED FRACTURE MECHANICS</i> , Volume: 84, Special Issue: SI, Pages: 140-148, ISSN: 0167-8442, eISSN: 1872-7638, 2016;	2.025 / Q1
40.	Nelson, J.D.B., Nafovita, C., Isar, A. Semi-Local Scaling Exponent Estimation With Box-Penalty Constraints and Total-Variation Regularization, <i>IEEE TRANSACTIONS ON IMAGE PROCESSING</i> , Volume: 25, Issue: 7, Pages: 3167-3181, ISSN: 1057-7149, eISSN: 1941-0042, 2016;	3.735 / Q1

No.	Article	Impact Factor / Quartile in Category
41.	Nicoara, M., Locovei, C., Serban, V.A., Parthiban, R., Calin, M., Stoica, M. New Cu-Free Ti-Based Composites with Residual Amorphous Matrix, <i>MATERIALS</i> , Volume: 9, Issue: 5, Article Number: 331, ISSN: 1996-1944, 2016;	2.728 / Q1
42.	Nicoara, M., Raduta, A., Parthiban, R., Locovei, C., Eckert, J., Stoica, M. Low Young's modulus Ti-based porous bulk glassy alloy without cytotoxic elements, <i>ACTA BIOMATERIALIA</i> , Volume: 36, Pages: 323-331, ISSN: 1742-7061, eISSN: 1878-7568, 2016;	6.008 / Q1
43.	Paulescu, M., Stefu, N., Calinoiu, D., Paulescu, E., Pop, N., Boata, R., Mares, O. Angstrom-Preseott equation: Physical basis, empirical models and sensitivity analysis, <i>RENEWABLE & SUSTAINABLE ENERGY REVIEWS</i> , Volume: 62, Pages: 495-506, ISSN: 1364-0321, 2016;	6.798 / Q1
44.	Petrisor, C. Stabilization of a nonlinear control system on the Lie group $SO(3) \times R-3 \times R-3$, <i>JOURNAL OF NONLINEAR SCIENCES AND APPLICATIONS</i> , Volume: 9, Issue: 5, Pages: 2019-2030, ISSN: 2008-1898, eISSN: 2008-1901, 2016;	1.176 / Q1
45.	Petrovic, A., Lelea, D., Laza, I. The comparative analysis on using the NEPCM materials and nanofluids for microchannel cooling solutions, <i>INTERNATIONAL COMMUNICATIONS IN HEAT AND MASS TRANSFER</i> , Volume: 79, Pages: 39-45, ISSN: 0735-1933, eISSN: 1879-0178, 2016;	2.559 / Q1
46.	Radac, M.B., Precup, R.E. Model-free constrained data-driven iterative reference input tuning algorithm with experimental validation, <i>INTERNATIONAL JOURNAL OF GENERAL SYSTEMS</i> , Volume: 45, Issue: 4, Pages: 455-476, ISSN: 0308-1079, eISSN: 1563-5104, 2016;	1.677 / Q1
47.	Radac, M.B., Precup, R.E. Three-level hierarchical model-free learning approach to trajectory tracking control, <i>ENGINEERING APPLICATIONS OF ARTIFICIAL INTELLIGENCE</i> , Volume: 55, Pages: 103-118, ISSN: 0952-1976, eISSN: 1873-6769, 2016;	2.368 / Q1
48.	Raduta, A., Nicoara, M., Locovei, C., Eckert, J., Stoica, M. Ti-based bulk glassy composites obtained by replacement of Ni with Ga, <i>INTERMETALLICS</i> , Volume: 69, Pages: 28-34, ISSN: 0966-9795, eISSN: 1879-0216, 2016;	2.541 / Q1
49.	Ramasamy, P., Szabo, A., Borzel, S., Eckert, J., Stoica, M., Bardos, A. High pressure die casting of Fe-based metallic glass, <i>SCIENTIFIC REPORTS</i> , Volume: 6, Article Number: 35258, PubMed ID: 27725780, ISSN: 2045-2322, 2016;	5.228 / Q1
50.	Roman, R.C., Radac, M.B., Precup, R.E. Multi-input-multi-output system experimental validation of model-free control and virtual reference feedback tuning techniques, <i>IET CONTROL THEORY AND APPLICATIONS</i> , Volume: 10, Issue: 12, Special Issue: SI, Pages: 1395-1403, ISSN: 1751-8644, eISSN: 1751-8652, 2016;	1.957 / Q1
51.	Sahebkar, A., Gurban, C., Serban, A., Andrica, F., Serban, M.C. Effects of supplementation with pomegranate juice on plasma C-reactive protein concentrations: A systematic review and meta-analysis of randomized controlled trials, <i>PHYTOMEDICINE</i> , Volume: 23, Issue: 11, Special Issue: SI, Pages: 1095-1102, PubMed ID: 26922037, ISSN: 0944-7113, eISSN: 1618-095X, 2016;	2.937 / Q1
52.	Sarac, B., Zhang, L., Kosiba, K., Pauly, S., Stoica, M., Eckert, J. Towards the Better: Intrinsic Property Amelioration in Bulk Metallic Glasses, <i>SCIENTIFIC REPORTS</i> , Volume: 6, Article Number: 27271, PubMed ID: 27273477, ISSN: 2045-2322, 2016;	5.228 / Q1
53.	Segneanu, A.E., Damian, D., Hulka, I., Grozescu, I., Salifoglou, A. A simple and rapid method for calixarene-based selective extraction of bioactive molecules from natural products, <i>AMINO ACIDS</i> , Volume: 48, Issue: 3, Pages: 849-858, PubMed ID: 26597796, ISSN: 0939-4451, eISSN: 1438-2199, 2016	3.196 / Q2
54.	Serban, D.A., Weissenborn, O., Geller, S., Marsavina, L., Gude, M. Evaluation of the mechanical and morphological properties of long fibre reinforced polyurethane rigid foams, <i>POLYMER TESTING</i> , Volume: 49, Pages: 121-127, ISSN: 0142-9418, eISSN: 1873-2348, 2016;	2.35 / Q1

No.	Article	Impact Factor / Quartile in Category
55.	Shahabi, H.S., Scudino, S., Kaban, I., Stoica, M., Escher, B., Menzel, S., Vaughan, G.B.M., Kuhn, U., Eckert, J. Mapping of residual strains around a shear band in bulk metallic glass by nanobeam X-ray diffraction, ACTA MATERIALIA, Volume: 111, Pages: 187-193, ISSN: 1359-6454, eISSN: 1873-2453, 2016;	5.058 / Q1
56.	Sopu, D., Foroughi, A., Stoica, M., Eckert, J. Brittle-to-Ductile Transition in Metallic Glass Nanowires, NANO LETTERS, Volume: 16, Issue: 7, Pages: 4467-4471, PubMed ID: 27248329, ISSN: 1530-6984, eISSN: 1530-6992, 2016;	13.779 / Q1
57.	Sopu, D., Soyarslan, C., Sarac, B., Bargmann, S., Stoica, M., Eckert, J. Structure-property relationships in nanoporous metallic glasses, ACTA MATERIALIA, Volume: 106, Pages: 199-207, ISSN: 1359-6454, eISSN: 1873-2453, 2016;	5.058 / Q1
58.	Stefu, N., Paulescu, M., Blaga, R., Calinoiu, D., Pop, N., Boata, R., Paulescu, E. A theoretical framework for Angstrom equation. Its virtues and liabilities in solar energy estimation, ENERGY CONVERSION AND MANAGEMENT, Volume: 112, Pages: 236-245, ISSN: 0196-8904, eISSN: 1879-2227, 2016;	4.801 / Q1
59.	Susan-Resiga, D., Vekas, L. Ferrofluid-based magnetorheological fluids: tuning the properties by varying the composition at two hierarchical levels, RHEOLOGICA ACTA, Volume: 55, Issue: 7, Pages: 581-595, ISSN: 0035-4511, eISSN: 1435-1528, 2016;	2.184 / Q1
60.	Tekle-Rottering, A., Jewell, K.S., Reisz, E., Lutze, H.V., Ternes, T.A., Schmidt, W., Schmidt, T.C. Ozonation of piperidine, piperazine and morpholine: Kinetics, stoichiometry, product formation and mechanistic considerations, WATER RESEARCH, Volume: 88, Pages: 960-971, PubMed ID: 26624229, ISSN: 0043-1354, 2016;	5.991 / Q1
61.	Tekle-Rottering, A., Reisz, E., Jewell, K.S., Lutze, H.V., Ternes, T.A., Schmidt, W., Schmidt, T.C. Ozonation of pyridine and other N-heterocyclic aromatic compounds: Kinetics, stoichiometry, identification of products and elucidation of pathways, WATER RESEARCH, Volume: 102, Pages: 582-593, PubMed ID: 27448509, ISSN: 0043-1354, 2016;	5.991 / Q1
62.	Tekle-Rottering, A., von Sonntag, C., Reisz, E., vom Eyser, C., Lutze, H.V., Turk, J., Naumov, S., Schmidt, W., Schmidt, T.C. Ozonation of anilines: Kinetics, stoichiometry, product identification and elucidation of pathways, WATER RESEARCH, Volume: 98, Pages: 147-159, PubMed ID: 27088249, ISSN: 0043-1354, 2016;	5.991 / Q1
63.	Tiwari, A.K., Albulescu, C.T. Oil price and exchange rate in India: Fresh evidence from continuous wavelet approach and asymmetric, multi-horizon Granger-causality tests, APPLIED ENERGY, Volume: 179, Pages: 272-283, ISSN: 0306-2619, eISSN: 1872-9118, 2016;	5.746 / Q1
64.	Tiwari, A.K., Albulescu, C.T. Renewable-to-total electricity consumption ratio: Estimating the permanent or transitory fluctuations based on flexible Fourier stationarity and unit root tests, RENEWABLE & SUSTAINABLE ENERGY REVIEWS, Volume: 57, Pages: 1409-1427, ISSN: 1364-0321, 2016;	6.798 / Q1
65.	Tiwari, A.K., Mutascu, M.I., Albulescu, C.T. Continuous wavelet transform and rolling correlation of European stock markets, INTERNATIONAL REVIEW OF ECONOMICS & FINANCE, Volume: 42, Pages: 237-256, ISSN: 1059-0560, eISSN: 1873-8036, 2016;	1.846 / Q1
66.	Topirceanu, A., Duma, A., Udrescu, M. Uncovering the fingerprint of online social networks using a network motif based approach, COMPUTER COMMUNICATIONS, Volume: 73, Special Issue: SI, Pages: 167-175, ISSN: 0140-3664, eISSN: 1873-703X, 2016;	2.099 / Q1
67.	Totorean, A.F., Bernad, S.I., Susan-Resiga, R.F. Fluid dynamics in helical geometries with applications for by-pass grafts, APPLIED MATHEMATICS AND COMPUTATION, Volume: 272, Pages: 604-613, ISSN: 0096-3003, eISSN: 1873-5649, 2016;	1.345 / Q1

No.	Article	Impact Factor / Quartile in Category
68.	Udrescu, L., Sbarcea, L., Topirceanu, A., Iovanovici, A., Kurunczi, L., Bogdan, P., Udrescu, M. Clustering drug-drug interaction networks with energy model layouts: community analysis and drug repurposing, SCIENTIFIC REPORTS, Volume: 6, Article Number: 32745, PubMed ID: 27599720, ISSN: 2045-2322, 2016;	5.228 / Q1
69.	Unlusayin, M., Hadaruga, N.G., Rusu, G., Gruia, A.T., Paunescu, V., Hadaruga, D.I. Nano-encapsulation competitiveness of omega-3 fatty acids and correlations of thermal analysis and Karl Fischer water titration for European anchovy (<i>Engraulis encrasicolus</i> L.) oil/beta-cyclodextrin complexes, LWT-FOOD SCIENCE AND TECHNOLOGY, Volume: 68, Pages: 135-144, ISSN: 0023-6438, eISSN: 1096-1127, 2016;	2.711 / Q1
70.	Utu, I.D., Mitelea, I., Urgan, S.D., Craciunescu, C.M., Transformation and Precipitation Reactions by Metal Active Gas Pulsed Welded Joints from X2CrNiMoN22-5-3 Duplex Stainless Steels, MATERIALS, Volume: 9, Issue: 7, Article Number: 606, ISSN: 1996-1944, 2016;	2.728 / Q1
71.	Zagari, G., Zucco, G., Madeo, A., Ungureanu, V., Zinno, R., Dubina, D. Evaluation of the erosion of critical buckling load of cold-formed steel members in compression based on Koiter asymptotic analysis, THIN-WALLED STRUCTURES, Volume: 108, Pages: 193-204, ISSN: 0263-8231, eISSN: 1879-3223, 2016;	2.063 / Q1

Papers in ISI Journals

1. Abdullah, A.D., Gisen, J.I.A., van der Zaag, P., Savenije, H.H.G., Karim, U.F.A., Masih, I., Popescu, I. Predicting the salt water intrusion in the Shatt al-Arab estuary using an analytical approach, *HYDROLOGY AND EARTH SYSTEM SCIENCES*, Volume: 20, Issue: 10, Pages: 4031-4042, ISSN: 1027-5606, eISSN: 1607-7938, 2016;
2. Aciu, R.M., Ciocarlie, H. Runtime Translation of the Java Bytecode to OpenCL and GPU Execution of the Resulted Code, *ACTA POLYTECHNICA HUNGARICA*, Volume: 13, Issue: 3, Pages: 25-44, ISSN: 1785-8860, 2016;
3. Albulescu, C.T., Pepin, D., Tiwari, A.K. A RE-EXAMINATION OF REAL INTEREST PARITY IN CEECs USING "OLD" AND "NEW" SECOND-GENERATION PANEL UNIT ROOT TESTS, *BULLETIN OF ECONOMIC RESEARCH*, Volume: 68, Issue: 2, Pages: 133-150, ISSN: 0307-3378, eISSN: 1467-8586, 2016;
4. Albulescu, C.T., Tamasila, M. Exploring the role of FDI in enhancing the entrepreneurial activity in Europe: a panel data analysis, *INTERNATIONAL ENTREPRENEURSHIP AND MANAGEMENT JOURNAL*, Volume: 12, Issue: 3, Pages: 629-657, ISSN: 1554-7191, eISSN: 1555-1938, 2016;
5. Albulescu, C.T., Tamasila, M., Taucean, I.M. Shadow economy, tax policies, institutional weakness and financial stability in selected OECD countries, *ECONOMICS BULLETIN*, Volume: 36, Issue: 3, Pages: 1868-+, ISSN: 1545-2921, 2016;
6. Alekseev, A.K., Bistriian, D.A., Bondarev, A.E., Navon, I.M. On linear and nonlinear aspects of dynamic mode decomposition, *INTERNATIONAL JOURNAL FOR NUMERICAL METHODS IN FLUIDS*, Volume: 82, Issue: 6, Pages: 348-371, ISSN: 0271-2091, eISSN: 1097-0363, 2016;
7. Andoni, M., Medeleanu, M., Stefanut, M., Cata, A., Ienascu, I., Tanasie, C., Pop, R. Theoretical determination of the redox electrode potential of cyaniding, *JOURNAL OF THE SERBIAN CHEMICAL SOCIETY*, Volume: 81, Issue: 2, Pages: 177-186, ISSN: 0352-5139, 2016;
8. Anton, A.A., Muntean, S., Susan-Resiga, R.F. SWIRL2D: AN INTERFACE TRACKING ALGORITHM FOR COMPUTING THE TWO-DIMENSIONAL SWIRLING FLOWS WITH STAGNANT REGION, *PROCEEDINGS OF THE ROMANIAN ACADEMY SERIES A-MATHEMATICS PHYSICS TECHNICAL SCIENCES INFORMATION SCIENCE*, Volume: 17, Issue: 4, Pages: 366-373, ISSN: 1454-9069, 2016;
9. Aparaschivei, D., Todea, A., Pausescu, I., Badea, V., Medeleanu, M., Sisu, E., Puiu, M., Chirita-Emandi, A., Peter, F. Synthesis, characterization and enzymatic degradation of copolymers of epsilon-caprolactone and hydroxy-fatty acids, *PURE AND APPLIED CHEMISTRY*, Volume: 88, Issue: 12, Pages: 1191-1201, ISSN: 0033-4545, eISSN: 1365-3075, 2016;
10. Apostol, D.A., Stuparu, F., Constantinescu, D.M., Marsavina, L., Linul, E. Crack Length Influence on Stress Intensity Factors for the Asymmetric Four-point Bending Testing of a Polyurethane Foam, *MATERIALE PLASTICE*, Volume: 53, Issue: 2, Pages: 280-282, ISSN: 0025-5289, 2016;
11. Apostol, D.A., Stuparu, F., Constantinescu, D.M., Marsavina, L., Linul, E. Experimental and XFEM Analysis of Mode II Propagating Crack in a Polyurethane Foam, *MATERIALE PLASTICE*, Volume: 53, Issue: 4, Pages: 685-688, ISSN: 0025-5289, 2016;
12. Ardelean, R., Davidescu, C.M., Dragan, E.S., Popa, A., Marcu, C., Negrea, A. Adsorption of Phenol or Phenol Derivatives onto Styrene-1%(15%) divinylbenzene Polymeric Adsorbents Functionalized with Aminopropyl(benzyl)phosphonic Groups, *REVISTA DE CHIMIE*, Volume: 67, Issue: 11, Pages: 2180-2183, ISSN: 0034-7752, 2016;
13. Ardit, M., Borcanescu, S., Cruciani, G., Dondi, M., Lazau, I., Pacurariu, C., Zanelli, C. Ni-Ti Codoped Hiconite Ceramic Pigments by Combustion Synthesis: Crystal Structure and Optical Properties, *JOURNAL OF THE AMERICAN CERAMIC SOCIETY*, Volume: 99, Issue: 5, Pages: 1749-1760, ISSN: 0002-7820, eISSN: 1551-2916, 2016;
14. Badea, C., Dan, S. Unburned Clay Bound Building Materials for Masonry, *MATERIALE PLASTICE*, Volume: 53, Issue: 4, Pages: 681-684, ISSN: 0025-5289, 2016;
15. Banica, R., Ursu, D., Svera, P., Sarvas, C., Rus, S.F., Novaconi, S., Kellenberger, A., Racu, A.V., Nyari, T., Vaszilcsin, N. Electrical properties optimization of silver nanowires supported on polyethylene terephthalate, *PARTICULATE SCIENCE AND TECHNOLOGY*, Volume: 34, Issue: 2, Pages: 217-222, ISSN: 0272-6351, eISSN: 1548-0046, 2016;
16. Baralic, D., Lazar, I.C. A note on the combinatorial structure of finite and locally finite simplicial complexes of nonpositive curvature, *BULLETIN MATHEMATIQUE DE LA SOCIETE DES SCIENCES MATHÉMATIQUES DE ROUMANIE*, Volume: 59, Issue: 3, Pages: 205-216, ISSN: 1220-3874, eISSN: 2065-0264, 2016;

17. Bedelea, B., Muntean, S., Campean, M. Analysis of Drying Kiln Aerodynamics Based on a Full Three-Dimensional Turbulent Numerical Computation, *DRVNA INDUSTRIJA*, Volume: 67, Issue: 1, Pages: 53-64, ISSN: 0012-6772, eISSN: 1847-1153, 2016;
18. Beevers, L., Popescu, I., Pan, Q., Pender, D. Applicability of a coastal morphodynamic model for fluvial environments, *ENVIRONMENTAL MODELLING & SOFTWARE*, Volume: 80, Pages: 83-99, ISSN: 1364-8152, eISSN: 1873-6726, 2016;
19. Belega, D., Petri, D. Accuracy analysis of the sine-wave parameters estimation by means of the windowed three-parameter sine-fit algorithm, *DIGITAL SIGNAL PROCESSING*, Volume: 50, Pages: 12-23, ISSN: 1051-2004, eISSN: 1095-4333, 2016;
20. Belega, D., Petri, D., Dallet, D. Accuracy analysis of complex sinusoid amplitude and phase estimation by means of the interpolated discrete-time Fourier transform algorithm, *DIGITAL SIGNAL PROCESSING*, Volume: 59, Pages: 9-18, ISSN: 1051-2004, eISSN: 1095-4333, 2016;
21. Belega, D., Petri, D., Dallet, D. Impact of harmonics on the interpolated DFT frequency estimator, *MECHANICAL SYSTEMS AND SIGNAL PROCESSING*, Volume: 66-67, Pages: 349-360, ISSN: 0888-3270, 2016;
22. Berdich, K., Gentil, F., Parente, M., Garbe, C., Santos, C., Paco, J., Jorge, R.M.N., Martins, P., Faur, N. Finite element analysis of the transfer of sound in the myringosclerotic ear, *COMPUTER METHODS IN BIOMECHANICS AND BIOMEDICAL ENGINEERING*, Volume: 19, Issue: 3, Pages: 248-256, ISSN: 1025-5842, eISSN: 1476-8259, 2016;
23. Bernad, S.I., Totorean, A.E., Vekas, L. Particles deposition induced by the magnetic field in the coronary bypass graft model, *JOURNAL OF MAGNETISM AND MAGNETIC MATERIALS*, Volume: 401, Pages: 269-286, ISSN: 0304-8853, eISSN: 1873-4766, 2016;
24. Binzar, T., Pater, F., Nadaban, S. On fuzzy normed algebras, *JOURNAL OF NONLINEAR SCIENCES AND APPLICATIONS*, Volume: 9, Issue: 9, Pages: 5488-5496, ISSN: 2008-1898, eISSN: 2008-1901, 2016;
25. Birdeanu, M., Fagadar-Cosma, G., Sebarchievici, I., Birdeanu, A.V., Taranu, B., Taranu, I., Fagadar-Cosma, E. Zn(Ta_{1-x}Nbx)(₂)O-6 nanomaterials. Synthesis, characterization and corrosion behavior, *JOURNAL OF THE SERBIAN CHEMICAL SOCIETY*, Volume: 81, Issue: 2, Pages: 163-175, ISSN: 0352-5139, 2016;
26. Biro, E., Budugan, D., Todea, A., Peter, F., Klebert, S., Feczko, T. Recyclable solid-phase biocatalyst with improved stability by sol-gel entrapment of beta-D-galactosidase, *JOURNAL OF MOLECULAR CATALYSIS B-ENZYMATIC*, Volume: 123, Pages: 81-90, ISSN: 1381-1177, eISSN: 1873-3158, 2016;
27. Bistran, D.A., Susan-Resiga, R.F. Weighted proper orthogonal decomposition of the swirling flow exiting the hydraulic turbine runner, *APPLIED MATHEMATICAL MODELLING*, Volume: 40, Issue: 5-6, Pages: 4057-4078, ISSN: 0307-904X, eISSN: 1872-8480, 2016;
28. Bob, C., Marginean, S., Scurt, A. Theoretical/experimental study of reinforced-concrete frame with masonry infill, *PROCEEDINGS OF THE INSTITUTION OF CIVIL ENGINEERS-STRUCTURES AND BUILDINGS*, Volume: 169, Issue: 11, Pages: 825-839, ISSN: 0965-0911, 2016;
29. Boboescu, I.Z., Gherman, V.D., Lakatos, G., Pap, B., Biro, T., Maroti, G. Surpassing the current limitations of biohydrogen production systems: The case for a novel hybrid approach, *BIORESOURCE TECHNOLOGY*, Volume: 204, Pages: 192-201, PubMed ID: 26790867, ISSN: 0960-8524, eISSN: 1873-2976, 2016;
30. Boncalo, O., Amaricai, A., Mihancea, P.F., Savin, V. Memory trade-offs in layered self-corrected min-sum LDPC decoders, *ANALOG INTEGRATED CIRCUITS AND SIGNAL PROCESSING*, Volume: 87, Issue: 2, Special Issue: SI, Pages: 169-180, ISSN: 0925-1030, eISSN: 1573-1979, 2016;
31. Boran, S., Tamas, A. The Mixtures of Castor Oil and Adipic Esters with Biolubricating Characteristics, *MATERIALE PLASTICE* Volume: 53 Issue: 3 Pages: 505-508, ISSN: 0025-5289, 2016;
32. Bordeasu, I., Micu, L.M., Mitelea, I., Utu, I.D., Pirvulescu, L.D., Sirbu, N.A. Cavitation Erosion of HVOF Metal-ceramic Composite Coatings Deposited onto Duplex Stainless Steel Substrate, *MATERIALE PLASTICE*, Volume: 53, Issue: 4, Pages: 781-786, ISSN: 0025-5289, 2016;
33. Bordeasu, I., Mitelea, I., Salcianu, L., Craciunescu, C.M. Cavitation Erosion Mechanisms of Solution Treated X5CrNi18-10 Stainless Steels, *JOURNAL OF TRIBOLOGY-TRANSACTIONS OF THE ASME*, Volume: 138, Issue: 3, Article Number: 031102, ISSN: 0742-4787, eISSN: 1528-8897, 2016;
34. Branisteanu, B., Retezan, A., Anghel, I. SPRINKLER ACTIVATION TIME IN A REDUCED SCALE CAR ROAD TUNNEL, *PROCEEDINGS OF THE ROMANIAN ACADEMY SERIES A-MATHEMATICS PHYSICS TECHNICAL SCIENCES INFORMATION SCIENCE*, Volume: 17, Issue: 4, Pages: 352-357, ISSN: 1454-9069, 2016;

35. Brzdek, J., Cadariu, L. Stability for a family of equations generalizing the equation of p-Wright affine functions, *APPLIED MATHEMATICS AND COMPUTATION*, Volume: 276, Pages: 158-171, ISSN: 0096-3003, eISSN: 1873-5649, 2016;
36. Brzdek, J., Cadariu, L., Cieplinski, K., Fosner, A., Lesniak, Z. Survey on Recent Ulam Stability Results Concerning Derivations, *JOURNAL OF FUNCTION SPACES*, Article Number: 1235103, ISSN: 2314-8896, eISSN: 2314-8888, 2016;
37. Bunia, I., Socoliuc, V., Vekas, L., Doroftei, F., Varganici, C., Coroaba, A., Simionescu, B.C., Mihai, M. Superparamagnetic Composites Based on Ionic Resin Beads/CaCO₃/Magnetite, *CHEMISTRY-A EUROPEAN JOURNAL*, Volume: 22, Issue: 50, Pages: 18036-18044, PubMed ID: 27805763, ISSN: 0947-6539, eISSN: 1521-3765, 2016;
38. Buse, C., O'Regan, D., Sailerli, O. An inequality concerning the growth bound of a discrete evolution family on a complex Banach space, *JOURNAL OF DIFFERENCE EQUATIONS AND APPLICATIONS*, Volume: 22, Issue: 7, Pages: 904-912, ISSN: 1023-6198, eISSN: 1563-5120, 2016;
39. Buse, C., O'Regan, D., Sailerli, O., Tabassum, A. Hyers-Ulam stability and discrete dichotomy for difference periodic systems, *BULLETIN DES SCIENCES MATHÉMATIQUES*, Volume: 140, Issue: 8, Pages: 908-934, ISSN: 0007-4497, eISSN: 1952-4773, 2016;
40. Butnariu, M., Sarac, I., Pentea, M., Samfira, I., Negrea, A., Motoc, M., Buzatu, A.R., Ciopec, M. Approach for Analyse Stability of Lutein from *Tropaeolum majus*, *REVISTA DE CHIMIE*, Volume: 67, Issue: 3, Pages: 503-506, ISSN: 0034-7752, 2016;
41. Cacciola, M., Berdie, A. Studies on Approximation Methods in Calculating the Magnetic Dipolar Interaction Energy, and Its Impact on the Relaxation Time of Magnetic Nanoparticle Systems, *ACTA PHYSICA POLONICA A*, Volume: 129, Issue: 1, Pages: 88-96, ISSN: 0587-4246, eISSN: 1898-794X, 2016;
42. Cacciola, M., Osaci, M. Modelling the Influence of Size Distribution and Effective Magnetic Anisotropy Constants on the Magnetic Hyperthermia Process, *CURRENT NANOSCIENCE*, Volume: 12, Issue: 4, Pages: 469-476, ISSN: 1573-4137, eISSN: 1875-6786, 2016;
43. Cacciola, M., Osaci, M. Studies about the influence of self-organization of colloidal magnetic nanoparticles on the magnetic N_{el} relaxation time, *COLLOID JOURNAL*, Volume: 78, Issue: 4, Pages: 448-458, ISSN: 1061-933X, eISSN: 1608-3067, 2016;
44. Camacho, O.M.F., Mihet-Popa, L. Fast Charging and Smart Charging Tests for Electric Vehicles Batteries Using Renewable Energy, *OIL & GAS SCIENCE AND TECHNOLOGY-REVUE D IFP ENERGIES NOUVELLES*, Volume: 71, Issue: 1, Article Number: 13, ISSN: 1294-4475, eISSN: 1953-8189, 2016;
45. Cercelaru, C., Ionel, I., Balogh, R.M. ODOUR CAUSING DISCOMFORT AND THEIR IMPACT ON HUMAN HEALTH, *JOURNAL OF ENVIRONMENTAL PROTECTION AND ECOLOGY*, Volume: 17, Issue: 2, Pages: 427-434, ISSN: 1311-5065, 2016;
46. Chendes, R., Bob, C., Badea, C., Podoleanu, C.E., Dan, S., Iures, L. Experimental Research on Recycled Concrete Fines, *REVISTA DE CHIMIE*, Volume: 67, Issue: 9, Pages: 1868-1871, ISSN: 0034-7752, 2016;
47. Cimporescu, A., Todea, A., Badea, V., Paul, C., Peter, F. Efficient kinetic resolution of 1,5-dihydroxy-1,2,3,4-tetrahydronaphthalene catalyzed by immobilized Burkholderia cepacia lipase in batch and continuous-flow system, *PROCESS BIOCHEMISTRY*, Volume: 51, Issue: 12, Pages: 2076-2083, ISSN: 1359-5113, eISSN: 1873-3298, 2016;
48. Cindea, L., Hatiegan, C., Pop, N., Negrea, R., Raduca, E., Gillich, G.R., Danut, M., Nedeloni, M.D. The influence of thermal field in the electric arc welding of X60 carbon steel components in the CO₂ environment, *APPLIED THERMAL ENGINEERING*, Volume: 103, Pages: 1164-1175, ISSN: 1359-4311, 2016;
49. Cioca, L.I., Ivascu, L. INVESTIGATING OCCUPATIONAL DISEASES IN THE METALLURGICAL INDUSTRY, *METALURGIJA* Volume: 55 Issue: 4 Pages: 852-854, ISSN: 0543-5846, eISSN: 1334-2576, 2016;
50. Ciocan, T., Susan-Resiga, R.F., Muntean, S. Modelling and optimization of the velocity profiles at the draft tube inlet of a Francis turbine within an operating range, *JOURNAL OF HYDRAULIC RESEARCH*, Volume: 54, Issue: 1, Pages: 74-89, ISSN: 0022-1686, eISSN: 1814-2079, 2016;
51. Cires, I., Nani, V-M. Stability control for a huge excavator for surface excavation, *APPLIED MATHEMATICAL MODELLING* Volume: 40, Issue: 1, Pages: 388-397, ISSN: 0307-904X, eISSN: 1872-8480, 2016;
52. Ciubotariu, C.R., Frunzaverde, D., Marginean, G., Serban, V.A., Birdeanu, A.V. Optimization of the laser remelting process for HVOF-sprayed Stellite 6 wear resistant coatings, *OPTICS AND LASER TECHNOLOGY*, Volume: 77, Pages: 98-103, ISSN: 0030-3992, eISSN: 1879-2545, 2016;

53. Ciurdariu, L. SOME REFINEMENTS OF HARDY-TYPE INEQUALITIES, JOURNAL OF SCIENCE AND ARTS, Issue: 2, Pages: 129-140, ISSN: 1844-9581, 2016;
54. Cogliati, A., Canavesi, C., Hayes, A., Tankam, P., Duma, V.F., Santhanam, A., Thompson, K.P., Rolland, J.P. MEMS-based handheld scanning probe with pre-shaped input signals for distortion-free images in Gabor-domain optical coherence microscopy, OPTICS EXPRESS, Volume: 24, Issue: 12, Pages: 13365-13374, PubMed ID: 27410354, ISSN: 1094-4087, 2016;
55. Constantin, D., Mazilescu, C.A., Nagi, M., Draghici, A., Mihartescu, A.A. Perception of Cabin Air Quality among Drivers and Passengers, SUSTAINABILITY, Volume: 8, Issue: 9, Article Number: 852, ISSN: 2071-1050, 2016;
56. Craciunescu, C., Ercuta, A. Shape memory microactuation design by substrate's reinforcement layers, MATERIALS & DESIGN, Volume: 96, Pages: 364-369, ISSN: 0261-3069, eISSN: 1873-4197, 2016;
57. Craciunescu, E., Sinescu, C., Negrutiu, M.L., Pop, D.M., Lauer, H.C., Rominu, M., Hutiu, G., Bunoiu, M., Duma, V.F., Antoniac, I. Shear bond strength tests of zirconia veneering ceramics after chipping repair, JOURNAL OF ADHESION SCIENCE AND TECHNOLOGY, Volume: 30, Issue: 6, Pages: 666-676, ISSN: 0169-4243, eISSN: 1568-5616, 2016;
58. Crisan, A., Dubina, D. Bending-shear interaction in short coupling steel beams with reduced beam section, JOURNAL OF CONSTRUCTIONAL STEEL RESEARCH, Volume: 122, Pages: 190-197, ISSN: 0143-974X, eISSN: 1873-5983, 2016;
59. Curiac, D.I. Towards wireless sensor, actuator and robot networks: Conceptual framework, challenges and perspectives, JOURNAL OF NETWORK AND COMPUTER APPLICATIONS, Volume: 63, Pages: 14-23, ISSN: 1084-8045, 2016;
60. Curiac, D.I. Wireless Sensor Network Security Enhancement Using Directional Antennas: State of the Art and Research Challenges, SENSORS, Volume: 16, Issue: 4, Article Number: 488, ISSN: 1424-8220, 2016;
61. Curiac, D.I., Volosencu, C. A generic method to construct new customized-shaped chaotic systems using the relative motion concept, NONLINEAR ANALYSIS-MODELLING AND CONTROL, Volume: 21, Issue: 3, Pages: 413-423, ISSN: 1392-5113, 2016;
62. Dahlgaard, J.J., Pugna, A., Potra, S., Negrea, R., Mocan, M. A greenhouse approach for value cultivation, TOTAL QUALITY MANAGEMENT & BUSINESS EXCELLENCE, Volume: 27, Issue: 7-8, Special Issue: SI, Pages: 836-852, ISSN: 1478-3363, eISSN: 1478-3371, 2016;
63. Dan, A.M., Dragomir, T.L. A Sensitivity Based Improvement Method of a Cardiovascular Model in Exercise Scenario, CONTROL ENGINEERING AND APPLIED INFORMATICS, Volume: 18, Issue: 2, Pages: 77-85, ISSN: 1454-8658, 2016;
64. Dan, D., Tanasa, C., Stoian, V., Brata, S., Stoian, D., Nagy-Gyorgy, T., Florut, S.C. Passive house design-An efficient solution for residential buildings in Romania, ENERGY FOR SUSTAINABLE DEVELOPMENT, Volume: 32, Pages: 99-109, ISSN: 0973-0826, 2016;
65. Davidescu, C.M., Ardelean, R., Popa, A. Performance of poly(styrene-co-divinylbenzene) functionalized with different aminophosphonate pendant groups, in the removal of phenolic compounds from aqueous solutions, PURE AND APPLIED CHEMISTRY, Volume: 88, Issue: 10-11, Pages: 993-1004, ISSN: 0033-4545, eISSN: 1365-3075, 2016;
66. Dinu, F., Marginean, I., Dubina, D., Petran, I. Experimental testing and numerical analysis of 3D steel frame system under column loss, ENGINEERING STRUCTURES, Volume: 113, Pages: 59-70, ISSN: 0141-0296, eISSN: 1873-7323, 2016;
67. Draghici, I.A., Muntean, S., Bosioc, A.I., Ginga, G., Anton, L.E. UNSTEADY PRESSURE FIELD ANALYSIS AT PUMP INLET EQUIPPED WITH A SYMMETRICAL SUCTION ELBOW, PROCEEDINGS OF THE ROMANIAN ACADEMY SERIES A-MATHEMATICS PHYSICS TECHNICAL SCIENCES INFORMATION SCIENCE, Volume: 17, Issue: 3, Pages: 237-244, ISSN: 1454-9069, 2016;
68. Enache, F., Singeorzan, B., Miron, F.C., Scarlat, C.A. Improving Weak Soils Bearing Capacity by Using Gravel Cushion Reinforced with Geosynthetic Materials, MATERIALE PLASTICE, Volume: 53, Issue: 1, Pages: 52-57, ISSN: 0025-5289, 2016;
69. Ene, R.D., Marinca, V., Marinca, B. Analytic Approximate Solutions to the Boundary Layer Flow Equation over a Stretching Wall with Partial Slip at the Boundary, PLOS ONE, Volume: 11, Issue: 3, Article Number: e0149334, ISSN: 1932-6203, 2016;
70. Ene, R.D., Marinca, V., Marinca, V.B. Thin film flow of an Oldroyd 6-constant fluid over a moving belt: an analytic approximate solution, OPEN PHYSICS, Volume: 14, Issue: 1, Pages: 44-64, ISSN: 2391-5471, 2016;
71. Ene, R.D., Marinca, V., Marinca, V.B. Viscous flow and heat transfer over an unsteady stretching surface, OPEN PHYSICS, Volume: 14, Issue: 1, Pages: 371-381, ISSN: 2391-5471, 2016;

72. Ene, R.D., Pop, C., Petrisor, C. Stability and Analytic Solutions of an Optimal Control Problem on the Schrodinger Lie Group, OPEN PHYSICS, Volume: 14, Issue: 1, Pages: 549-558, ISSN: 2391-5471, 2016;
73. Epee, M.D.E., Mezei, J.Z., Motapon, O., Pop, N., Schneider, I.F. Reactive collisions of very low-energy electrons with H-2(+): rotational transitions and dissociative recombination, MONTHLY NOTICES OF THE ROYAL ASTRONOMICAL SOCIETY, Volume: 455, Issue: 1, Pages: 276-281, ISSN: 0035-8711, eISSN: 1365-2966, 2016;
74. Fagadar-Cosma, E., Lascu, A., Palade, A., Creanga, I., Fagadar-Cosma, G., Birdeanu, M. HYBRID MATERIAL BASED ON 5-(4-PYRIDYL)-10,15,20-TRIS(4-PHENOXYPHENYL)-PORPHYRIN AND GOLD COLLOID FOR CO₂ DETECTION, DIGEST JOURNAL OF NANOMATERIALS AND BIOSTRUCTURES, Volume: 11, Issue: 2, Pages: 419-424, ISSN: 1842-3582, 2016;
75. Fagadar-Cosma, E., Sebarchievici, I., Lascu, A., Creanga, I., Palade, A., Birdeanu, M., Taranu, B., Fagadar-Cosma, G. Optical and electrochemical behavior of new nano-sized complexes based on gold-colloid and Co-porphyrin derivative in the presence of H₂O₂, JOURNAL OF ALLOYS AND COMPOUNDS, Volume: 686, Pages: 896-904, ISSN: 0925-8388, eISSN: 1873-4669, 2016;
76. Fagadar-Cosma, E., Tarabukina, E., Zakharova, N., Birdeanu, M., Taranu, B., Palade, A., Creanga, I., Lascu, A., Fagadar-Cosma, G. Hybrids formed between polyvinylpyrrolidone and an A(3)B porphyrin dye: behaviour in aqueous solutions and chemical response to CO₂ presence, POLYMER INTERNATIONAL, Volume: 65, Issue: 2, Pages: 200-209, ISSN: 0959-8103, eISSN: 1097-0126, 2016;
77. Filip, I., Prostean, O., Vasar, C., Szeidert, I. An Improved Structure of an Adaptive Excitation Control System Operating under Short-Circuit, ADVANCES IN ELECTRICAL AND COMPUTER ENGINEERING, Volume: 16, Issue: 2, Pages: 43-50, ISSN: 1582-7445, eISSN: 1844-7600, 2016;
78. Filip, I., Szeidert, I. Adaptive fuzzy PI controller with shifted control singletons, EXPERT SYSTEMS WITH APPLICATIONS, Volume: 54, Pages: 1-12, ISSN: 0957-4174, eISSN: 1873-6793, 2016;
79. Floricel, A., Zagari, G., Ungureanu, V., Ciutina, A. Structural solutions based on intensive use of steel for over-roofing of existing precast concrete panel buildings, ADVANCES IN STRUCTURAL ENGINEERING, Volume: 19, Issue: 12, Pages: 1940-1948, ISSN: 1369-4332, eISSN: 2048-4011, 2016;
80. Frydenberg, M., Andone, D. Creating micro-videos to demonstrate technology learning and digital literacy, INTERACTIVE TECHNOLOGY AND SMART EDUCATION, Volume: 13, Issue: 4, Pages: 261-273, ISSN: 1741-5659, eISSN: 1758-8510, 2016;
81. Fulus, A., Ledeti, I., Vlase, G., Vlase, T., Soica, C., Dehelean, C., Oprean, C., Bojin, F., Suta, L.M., Bercean, V., Avram, S. Thermal degradation, kinetic analysis, and apoptosis induction in human melanoma for oleanolic and ursolic acids, JOURNAL OF THERMAL ANALYSIS AND CALORIMETRY, Volume: 125, Issue: 2, Pages: 759-768, ISSN: 1388-6150, eISSN: 1572-8943, 2016;
82. Gabor, A., Davidescu, C.M., Negrea, A., Ciopec, M., Muntean, C., Duteanu, N., Negrea, P. Sorption properties of Amberlite XAD 7 functionalized with sodium beta-glycerophosphate, PURE AND APPLIED CHEMISTRY, Volume: 88, Issue: 12, Pages: 1143-1154, ISSN: 0033-4545, eISSN: 1365-3075, 2016;
83. Gabor, A., Davidescu, C.M., Negrea, A., Ciopec, M., Negrea, P., Butnariu, M. Separation of La(III) Using Functionalized Material on Fixed Bed Column, REVISTA DE CHIMIE, Volume: 67, Issue: 11, Pages: 2225-2227, ISSN: 0034-7752, 2016;
84. Gabor, A., Davidescu, C.M., Popa, A., Negrea, A., Ciopec, M., Motoc, M., Lupa, L., Buzatu, A.R., Negrea, P. Equilibrium Studies for Crown Ether Impregnated Solid Support Used in the Removal Process of Nd(III), La(III), Sr(II), Tl(I), Eu(III), REVISTA DE CHIMIE, Volume: 67, Issue: 3, Pages: 580-583, ISSN: 0034-7752, 2016;
85. Gabor, A.E., Davidescu, C.M., Negrea, A., Ciopec, M., Butnariu, M., Ianasi, C., Muntean, C., Negrea, P. Lanthanum Separation from Aqueous Solutions Using Magnesium Silicate Functionalized with Tetrabutylammonium Dihydrogen Phosphate, JOURNAL OF CHEMICAL AND ENGINEERING DATA, Volume: 61, Issue: 1, Pages: 535-542, ISSN: 0021-9568, 2016;
86. Galbacs, G., Szokolai, H., Kormanyos, A., Metzinger, A., Szekeres, L., Marcu, C., Peter, F., Muntean, C., Negrea, A., Ciopec, M., Jancso, A. Cd(II) Capture Ability of an Immobilized, Fluorescent Hexapeptide, BULLETIN OF THE CHEMICAL SOCIETY OF JAPAN, Volume: 89, Issue: 2, Pages: 243-253, ISSN: 0009-2673, eISSN: 1348-0634, 2016;

87. Gama, M.C., Popescu, I., Mynett, A., Li, S., van Dam, A. MODELING EXTREME FLOOD EVENTS IN THE YELLOW RIVER USING UNSTRUCTURED GRIDS, *TRANSACTIONS OF THE ASABE*, Volume: 59, Issue: 1, Pages: 129-143, ISSN: 2151-0032, eISSN: 2151-0040, 2016;
88. Gavruta, L., Gavruta, P. SOME PROPERTIES OF OPERATOR-VALUED FRAMES, *ACTA MATHEMATICA SCIENTIA*, Volume: 36, Issue: 2, Pages: 469-476, ISSN: 0252-9602, eISSN: 1572-9087, 2016;
89. Gheju, M., Balcu, I., Jurchescu, P. Removal of hexavalent chromium from aqueous solutions by use of chemically modified sour cherry stones, *DESALINATION AND WATER TREATMENT*, Volume: 57, Issue: 23, Pages: 10776-10789, ISSN: 1944-3994, eISSN: 1944-3986, 2016;
90. Gheju, M., Balcu, I., Mosoarca, G. Removal of Cr(VI) from aqueous solutions by adsorption on MnO₂, *JOURNAL OF HAZARDOUS MATERIALS*, Volume: 310, Pages: 270-277, ISSN: 0304-3894, eISSN: 1873-3336, 2016;
91. Gheju, M., Balcu, I., Vancea, C. An investigation of Cr(VI) removal with metallic iron in the co presence of sand and/or MnO₂, *JOURNAL OF ENVIRONMENTAL MANAGEMENT*, Volume: 170, Pages: 145-151, ISSN: 0301-4797, eISSN: 1095-8630, 2016;
92. Grecu, E., Petrelean, D.C., Ionel, I. CARBON FOOTPRINT IMPORTANCE FOR AN INTEGRATED WASTE MANAGEMENT SYSTEM, *JOURNAL OF ENVIRONMENTAL PROTECTION AND ECOLOGY*, Volume: 17, Issue: 2, Pages: 593-602, ISSN: 1311-5065, 2016;
93. Hadaruga, D.I., Costescu, C.I., Corpas, L., Hadaruga, N.G., Isengard, H.D. Differentiation of rye and wheat flour as well as mixtures by using the kinetics of Karl Fischer water titration, *FOOD CHEMISTRY*, Volume: 195, Pages: 49-55, ISSN: 0308-8146, eISSN: 1873-7072, 2016;
94. Hadaruga, D.I., Unlusayin, M., Gruia, A.T., Birau, C., Rusu, G., Hadaruga, N.G., Thermal and oxidative stability of Atlantic salmon oil (*Salmo salar* L.) and complexation with beta-cyclodextrin, *BEILSTEIN JOURNAL OF ORGANIC CHEMISTRY*, Volume: 12, Pages: 179-191, ISSN: 1860-5397, 2016;
95. Herrmann, M., Ottesteanu, M., A MAP estimator based on geometric Brownian motion for sample distances of laser triangulation data, *OPTICS AND LASERS IN ENGINEERING*, Volume: 86, Pages: 98-105, ISSN: 0143-8166, eISSN: 1873-0302, 2016;
96. Hulka, I., Serban, V.A., Utu, D., Duteanu, N.M., Pascu, A., Roata, I., Maior, I. WEAR RESISTANCE OF LASER CLADDING NiCrBSi COMPOSITE COATINGS, *REVISTA ROMANA DE MATERIALE-ROMANIAN JOURNAL OF MATERIALS*, Volume: 46, Issue: 1, Pages: 49-54, ISSN: 1583-3186, 2016;
97. Ianas, C., Costisor, O., Putz, A.M., Lazau, R., Negrea, A., Niznansky, D., Sacarescu, L., Savii, C. Low temperature superparamagnetic nanocomposites obtained by Fe(acac)₃-SiO₂-PVA hybrid xerogel thermolysis, *PROCESSING AND APPLICATION OF CERAMICS*, Volume: 10, Issue: 4, Pages: 265-275, ISSN: 1820-6131, eISSN: 2406-1034, 2016;
98. Ianos, R., Istrate, R., Pacurariu, C., Lazau, R. Solution combustion synthesis of strontium aluminate, SrAl₂O₄, powders: single-fuel versus fuel-mixture approach, *PHYSICAL CHEMISTRY CHEMICAL PHYSICS*, Volume: 18, Issue: 2, Pages: 1150-1157, ISSN: 1463-9076, eISSN: 1463-9084, 2016;
99. Ihos, M., Bogatu, C., Cristea, I., Manea, F., Pode, R. Custom-made Dimensionally Stable Anodes for Diclofenac Electrochemical Degradation, *REVISTA DE CHIMIE*, Volume: 67, Issue: 8, Pages: 1462-1465, ISSN: 0034-7752, 2016;
100. Ihos, M., Lazau, C., Manea, F., Andres, L., Pode, R. DICLOFENAC DEGRADATION BY PHOTOCATALYTICALLY-ASSISTED ELECTROCHEMICAL METHOD, *JOURNAL OF ENVIRONMENTAL PROTECTION AND ECOLOGY*, Volume: 17, Issue: 1, Pages: 307-314, ISSN: 1311-5065, 2016;
101. Ilia, G., Iliescu, S., Popa, A., Visa, A., Maranescu, B., Simulescu, V., Pekar, M., Badea, V. Poly(alkylene-H-phosphonate)s obtained by direct esterification and oxidation of hypophosphorous acid with ethylene glycol, *JOURNAL OF MACROMOLECULAR SCIENCE PART A-PURE AND APPLIED CHEMISTRY*, Volume: 53, Issue: 1, Pages: 49-54, ISSN: 1060-1325, eISSN: 1520-5738, 2016;
102. Ioan, A., Stratan, A., Dubina, D. RE-CENTRING DUAL ECCENTRICALLY BRACED FRAMES WITH REMOVABLE LINKS, *PROCEEDINGS OF THE ROMANIAN ACADEMY SERIES A-MATHEMATICS PHYSICS TECHNICAL SCIENCES INFORMATION SCIENCE*, Volume: 17, Issue: 2, Pages: 169-177, ISSN: 1454-9069, 2016;
103. Ioan, A., Stratan, A., Dubina, D., Poljansek, M., Molina, F.J., Taucer, F., Pegon, P., Sabau, G. Experimental validation of re-centring capability of eccentrically braced frames with removable links, *ENGINEERING STRUCTURES*, Volume: 113, Pages: 335-346, ISSN: 0141-0296, eISSN: 1873-7323, 2016;

104. Ionita, I., Grigorita, L., Miloicov, C.B., Petre, I., Bernad, E., Craina, M., Diaconu, M., Citu, C., Radu, F., Oros, D., Boglut, A., Furau, G., Enatescu, V. The Role of Thrombophilia in Pregnancy, *REVISTA DE CHIMIE*, Volume: 67, Issue: 12, Pages: 2643–2647, ISSN: 0034–7752, 2016;
105. Isar, A., Oltean, M. Time-frequency localization as mother wavelet selecting criterion for wavelet modulation, *ANNALS OF TELECOMMUNICATIONS-ANNALES DES TELECOMMUNICATIONS*, Volume: 71, Issue: 1–2, Pages: 35–46, ISSN: 0003–4347, eISSN: 1958–9395, 2016;
106. Javadi, A., Bosioc, A., Nilsson, H., Muntean, S., Susan-Resiga, R. Experimental and Numerical Investigation of the Precessing Helical Vortex in a Conical Diffuser, With Rotor–Stator Interaction, *JOURNAL OF FLUIDS ENGINEERING-TRANSACTIONS OF THE ASME*, Volume: 138, Issue: 8, Article Number: 081106, ISSN: 0098–2202, eISSN: 1528–901X, 2016;
107. Jung, H.Y., Stoica, M., Yi, S., Kim, D.H., Eckert, J. Preparation of cast-iron-based nanocrystalline alloy with Cu and Nb addition, *INTERMETALLICS*, Volume: 69, Pages: 54–61, ISSN: 0966–9795, eISSN: 1879–0216, 2016;
108. Kalluf, F.J.H., Isfanuti, A.S., Tutelea, L.N., Moldovan-Popa, A., Boldea, I. 1-kW 2000–4500 r/min Ferrite PMSM Drive: Comprehensive Characterization and Two Sensorless Control Options, *IEEE TRANSACTIONS ON INDUSTRY APPLICATIONS*, Volume: 52, Issue: 5, Pages: 3980–3989, ISSN: 0093–9994, eISSN: 1939–9367, 2016;
109. Karancsi, O.L., Mitelea, I., Bratu, E.A. The Impact of Surface Treatment on the Implantation Results, *REVISTA DE CHIMIE*, Volume: 67, Issue: 8, Pages: 1646–1649, ISSN: 0034–7752, 2016;
110. Kiss, M.L., Chirita, M., Ieta, A., Sacarescu, L., Savii, C. Top-down synthesis of mesocrystalline -Fe₂O₃ submillimeter-sized rhombohedrons, *PARTICULATE SCIENCE AND TECHNOLOGY*, Volume: 34, Issue: 5, Pages: 571–579, ISSN: 0272–6351, eISSN: 1548–0046, 2016;
111. Koochi, R., Ahmed, S., Batkin, I., Groza, V., Shirmohammadi, S., Dajani, H.R. Dynamic Threshold Algorithm to Evaluate Trustworthiness of the Estimated Blood Pressure in Oscillometry, *IEEE INSTRUMENTATION & MEASUREMENT MAGAZINE*, Volume: 19, Issue: 5, Pages: 26–35, ISSN: 1094–6969, eISSN: 1941–0123, 2016;
112. Kovacic, J., Jerz, J., Minarikova, N., Marsavina, L., Linul, E. Scaling of compression strength in disordered solids: metallic foams, *FRATTURA ED INTEGRITA STRUTTURALE*, Issue: 36, Pages: 55–62, ISSN: 1971–8993, 2016;
113. Lascu, A., Palade, A., Fagadar-Cosma, G., Creanga, I., Ianas, C., Sebarchievici, I., Birdeanu, M., Fagadar-Cosma, E. Mesoporous manganese-porphyrin-silica hybrid nanomaterial sensitive to H₂O₂ fluorescent detection, *MATERIALS RESEARCH BULLETIN*, Volume: 74, Pages: 325–332, ISSN: 0025–5408, eISSN: 1873–4227, 2016;
114. Ledeti, A., Vlase, G., Vlase, T., Bercean, V., Murariu, M.S., Ledeti, I., Suta, L.M., Solid-state preformulation studies of amiodarone hydrochloride, *JOURNAL OF THERMAL ANALYSIS AND CALORIMETRY*, Volume: 126, Issue: 1, Pages: 181–187, ISSN: 1388–6150, eISSN: 1572–8943, 2016;
115. Ledeti, I., Bercean, V., Vlase, G., Vlase, T., Ledeti, A., Suta, L.M. Betulonic acid Study of thermal degradation by kinetic approach, *JOURNAL OF THERMAL ANALYSIS AND CALORIMETRY*, Volume: 125, Issue: 2, Pages: 785–791, ISSN: 1388–6150, eISSN: 1572–8943, 2016;
116. Ledeti, I., Ledeti, A., Vlase, G., Vlase, T., Matusz, P., Bercean, V., Suta, L.M., Piciu, D. Thermal stability of synthetic thyroid hormone L-thyroxine and L-thyroxine sodium salt hydrate both pure and in pharmaceutical formulations, *JOURNAL OF PHARMACEUTICAL AND BIOMEDICAL ANALYSIS*, Volume: 125, Pages: 33–40, PubMed ID: 26999320, ISSN: 0731–7085, eISSN: 1873–264X, 2016;
117. Lengyel, B.C., Cernescu, A., Voiconi, T., Ducan, D. Analytical and Experimental Determination of Elastic Properties for Synthetic Leather, *MATERIALE PLASTICE*, Volume: 53, Issue: 2, Pages: 283–286, ISSN: 0025–5289, 2016;
118. Lupa, L., Popa, A., Voda, R., Negrea, P., Ciopec, M., Vasile, A. Strontium adsorption on ionic liquid impregnated Florisil: Fixed-bed column studies, *SEPARATION SCIENCE AND TECHNOLOGY* Volume: 51 Issue: 15–16 Special Issue: SI Pages: 2554–2564, ISSN: 0149–6395, eISSN: 1520–5754, 2016;
119. Malaescu, I., Lungu, A., Marin, C.N., Vlazan, P., Sfirloaga, P., Turi, G.M. Experimental investigations of the structural transformations induced by the heat treatment in manganese ferrite synthesized by ultrasonic assisted co-precipitation method, *CERAMICS INTERNATIONAL*, Volume: 42, Issue: 15, Pages: 16744–16748, ISSN: 0272–8842, eISSN: 1873–3956, 2016;
120. Maranescu, B., Lupa, L., Visa, A. Synthesis, characterizations and Pb(II) sorption properties of cobalt phosphonate materials, *PURE AND APPLIED CHEMISTRY*, Volume: 88, Issue: 10–11, Pages: 979–992, ISSN: 0033–4545, eISSN: 1365–3075, 2016;

121. Marinica, O., Susan-Resiga, D., Balanean, F., Vizman, D., Socoliuc, V., Vekas, L. Nano-micro composite magnetic fluids: Magnetic and magnetorheological evaluation for rotating seal and vibration damper applications, *JOURNAL OF MAGNETISM AND MAGNETIC MATERIALS*, Volume: 406, Pages: 134-143, ISSN: 0304-8853, eISSN: 1873-4766, 2016;
122. Marsavina, L., Constantinescu, D.M., Linul, E., Stuparu, F.A., Apostol, D.A. Experimental and numerical crack paths in PUR foams, *ENGINEERING FRACTURE MECHANICS*, Volume: 167, Special Issue: S,I Pages: 68-83, ISSN: 0013-7944, eISSN: 1873-7315, 2016;
123. Marsavina, L., Kovacik, J., Linul, E. Experimental validation of micromechanical models for brittle aluminium alloy foam, *THEORETICAL AND APPLIED FRACTURE MECHANICS*, Volume: 83, Pages: 11-18, ISSN: 0167-8442, eISSN: 1872-7638, 2016;
124. Masu, S., Grecu, E. SOLUTIONS IN THE COAGULATION OF OIL WASTEWATER, *STUDIA UNIVERSITATIS BABES-BOLYAI CHEMIA*, Volume: 61, Issue: 4, Pages: 189-202, ISSN: 1224-7154, 2016;
125. Masu, S., Grecu, E., Oncioiu, I., Petrescu, M. For a sustainable development: Phytoremediation of oil-polluted soils by using birdsfoot trefoil crops, *ROMANIAN BIOTECHNOLOGICAL LETTERS*, Volume: 21, Issue: 6, Pages: 12010-12017, ISSN: 1224-5984, 2016;
126. Masu, S., Jurj, N.L., Lixandru, B., Burtica, G. APPLICATION OF FLY ASH AS AMENDMENT IN AGRICULTURAL FIELD OF *Avena sativa*, *ENVIRONMENTAL ENGINEERING AND MANAGEMENT JOURNAL*, Volume: 15, Issue: 12, Pages: 2681-2688, ISSN: 1582-9596, eISSN: 1843-3707, 2016;
127. Medeleanu, M., Olariu, T., Georgescu, D., Sisu, E., Mracec, M., Mracec, M. CONFORMATIONAL ANALYSIS AND FORMATION ENTHALPY OF (3R,5S,6R)-6-ACETYLAMIDOPENICILLANIC ACID CALCULATED BY THE PM3, PM6 AND PM7 SEMIEMPIRICAL MO METHODS, *REVUE ROUMAINE DE CHIMIE*, Volume: 61, Issue: 4-5, Pages: 445-458, ISSN: 0035-3930, 2016;
128. Medeleanu, M., Pascariu, M.C., Sisu, E., Olariu, T., Georgescu, D., Mracec, M., Mracec, M. ENTROPIC EFFECT AND THERMODYNAMIC PROPERTIES FOR THE CONFORMERS OF (3R,5S,6R)-6-ACETYLAMIDOPENICILLANIC ACID CALCULATED WITH THE PM3, PM6 AND PM7 SEMIEMPIRICAL MO METHODS, *REVUE ROUMAINE DE CHIMIE*, Volume: 61, Issue: 6-7, Pages: 597-607, ISSN: 0035-3930, 2016;
129. Mezei, J.Z., Colboc, F., Pop, N., Ilie, S., Chakrabarti, K., Niyonzima, S., Lepers, M., Bultel, A., Dulieu, O., Motapon, O., Tennyson, J., Hassouni, K., Schneider, I.F. Dissociative recombination and vibrational excitation of BF⁺ in low energy electron collisions, *PLASMA SOURCES SCIENCE & TECHNOLOGY*, Volume: 25, Issue: 5, Article Number: 055022, ISSN: 0963-0252, eISSN: 1361-6595, 2016;
130. Mitelea, I., Bordeasu, I., Utu, I.D., Karanci, O. Improvement of the Cavitation Erosion Resistance of Titanium Alloys Deposited by Plasma Spraying and Remelted by Laser, *MATERIALE PLASTICE*, Volume: 53, Issue: 1, Pages: 29-33, ISSN: 0025-5289, 2016;
131. Mitelea, I., Micu, L.M., Bordeasu, I., Craciunescu, C.M. Cavitation Erosion of Sensitized UNS S31803 Duplex Stainless Steels, *JOURNAL OF MATERIALS ENGINEERING AND PERFORMANCE*, Volume: 25, Issue: 5, Pages: 1939-1944, ISSN: 1059-9495, eISSN: 1544-1024, 2016;
132. Mitelea, I., Oanca, O., Bordeasu, I., Craciunescu, C.M. Cavitation Erosion of Cermet-Coated Aluminium Bronzes, *MATERIALS*, Volume: 9, Issue: 3, Article Number: 204, ISSN: 1996-1944, 2016;
133. Mitelea, I., Utu, I.D., Cutean, S., Craciunescu, C.M. TIG deposition of Ti on steel substrates using Cu as interlayer, *MATERIALS TESTING*, Volume: 58, Issue: 9, Pages: 725-730, ISSN: 0025-5300, 2016;
134. Modler, N., Winkler, A., Filippatos, A., Lovasz, E.C., Margineanu, D. Simulation and experimental investigation of active lightweight compliant mechanisms with integrated piezoceramic actuators, *SMART MATERIALS AND STRUCTURES*, Volume: 25, Issue: 8, Article Number: 085047, ISSN: 0964-1726, eISSN: 1361-665X, 2016;
135. Molcan, M., Gojzewski, H., Skumiel, A., Dutz, S., Kovac, J., Kubovcikova, M., Kopcansky, P., Vekas, L., Timko, M. Energy losses in mechanically modified bacterial magnetosomes, *JOURNAL OF PHYSICS D-APPLIED PHYSICS*, Volume: 49, Issue: 36, Article Number: 365002, ISSN: 0022-3727, eISSN: 1361-6463, 2016;
136. Montiel, J., Szucs, A., Boboescu, I.Z., Gherman, V.D., Kondorosi, E., Kereszt, A. Terminal Bacteroid Differentiation Is Associated With Variable Morphological Changes in Legume Species Belonging to the Inverted Repeat-Lacking Clade, *MOLECULAR PLANT-MICROBE INTERACTIONS*, Volume: 29, Issue: 3, Pages: 210-219, PubMed ID: 26713350, ISSN: 0894-0282, eISSN: 1943-7706, 2016;
137. Motoc, S., Manea, F., Iacob, A., Martinez-Joaristi, A., Gascon, J., Pop, A., Schoonman, J. Electrochemical Selective and Simultaneous Detection of Diclofenac and Ibuprofen in Aqueous Solution Using HKUST-1 Metal-Organic Framework-Carbon Nanofiber Composite Electrode, *SENSORS*, Volume: 16, Issue: 10, Article Number: 1719, ISSN: 1424-8220, 2016;

138. Muntean, C., Bozdog, M., Duma, S., Stefanescu, M. Study on the formation of Co_{1-x}Zn_xFe₂O₄ system using two low-temperature synthesis methods, *JOURNAL OF THERMAL ANALYSIS AND CALORIMETRY*, Volume: 123, Issue: 1, Pages: 117-126, ISSN: 1388-6150, eISSN: 1572-8943, 2016;
139. Musa, Z.N., Popescu, I., Mynett, A. Assessing the sustainability of local resilience practices against sea level rise impacts on the lower Niger delta, *OCEAN & COASTAL MANAGEMENT*, Volume: 130, Pages: 221-228, ISSN: 0964-5691, eISSN: 1873-524X, 2016;
140. Najati, A., Saem, M.M., Gavruta, P. FRAMES AND OPERATORS IN HILBERT C*-MODULES, OPERATORS AND MATRICES, Volume: 10, Issue: 1, Pages: 73-81, ISSN: 1846-3886, 2016;
141. Negoitescu, A., Tokar, A., Hamat, C. The Influence of the Air Thermal and Rainfall Regimes on Storage Lakes Water Turbidity, *MATERIALE PLASTICE*, Volume: 53, Issue: 3, Pages: 542-545, ISSN: 0025-5289, 2016;
142. Negrea, A., Ciopec, M., Negrea, P., Motoc, M., Hulka, I., Sarac, I., Petrescu, I., Vasileva, V., Butnariu, M. Studies Regarding the Use of Ash from Pyrolysis Rubber as an Amendment to Soils Used to Cover Waste Dumps, with Phalaris Arundinacea, *REVISTA DE CHIMIE*, Volume: 67, Issue: 11, Pages: 2164-2169, ISSN: 0034-7752, 2016;
143. Negrea, P., Negrea, A., Motoc, M., Ciopec, M., Gabor, A., Muntean, C. Influence of pH on Enzymatic Extract with Allelopathic Potential, *REVISTA DE CHIMIE*, Volume: 67, Issue: 2, Pages: 372-374, ISSN: 0034-7752, 2016;
144. Negrea, P., Popa, A., Lupa, L., Voda, R. Thallium removal through adsorption onto ionic liquid-impregnated solid support: influence of the impregnation conditions, *INTERNATIONAL JOURNAL OF ENVIRONMENTAL SCIENCE AND TECHNOLOGY*, Volume: 13, Issue: 8, Pages: 1873-1882, ISSN: 1735-1472, eISSN: 1735-2630, 2016;
145. Negru, R., Serban, D.A., Marsavina, L., Magda, A. Lifetime prediction in medium-cycle fatigue regime of notched specimens, *THEORETICAL AND APPLIED FRACTURE MECHANICS*, Volume: 84, Special Issue: SI, Pages: 140-148, ISSN: 0167-8442, eISSN: 1872-7638, 2016;
146. Nelson, J.D.B., Nafornita, C., Isar, A. Semi-Local Scaling Exponent Estimation With Box-Penalty Constraints and Total-Variation Regularization, *IEEE TRANSACTIONS ON IMAGE PROCESSING*, Volume: 25, Issue: 7, Pages: 3167-3181, ISSN: 1057-7149, eISSN: 1941-0042, 2016;
147. Nicoara, M., Locovei, C., Serban, V.A., Parthiban, R., Calin, M., Stoica, M. New Cu-Free Ti-Based Composites with Residual Amorphous Matrix, *MATERIALS*, Volume: 9, Issue: 5, Article Number: 331, ISSN: 1996-1944, 2016;
148. Nicoara, M., Raduta, A., Parthiban, R., Locovei, C., Eckert, J., Stoica, M. Low Young's modulus Ti-based porous bulk glassy alloy without cytotoxic elements, *ACTA BIOMATERIALIA*, Volume: 36, Pages: 323-331, ISSN: 1742-7061, eISSN: 1878-7568, 2016;
149. Niculescu, M., Sasca, V., Muntean, C., Milea, M.S., Rosu, D., Pascariu, M.C., Sisu, E., Ursoiu, I., Pode, V., Budrugaec, P. Thermal behavior studies of the homopolynuclear coordination compound iron(III) polyoxalate, *THERMOCHIMICA ACTA*, Volume: 623, Pages: 36-42, ISSN: 0040-6031, eISSN: 1872-762X, 2016;
150. Nimara, S., Amaricai, A., Boncalo, O., Popa, M. Multi-Level Simulated Fault Injection for Data Dependent Reliability Analysis of RTL Circuit Descriptions, *ADVANCES IN ELECTRICAL AND COMPUTER ENGINEERING*, Volume: 16, Issue: 1, Pages: 93-98, ISSN: 1582-7445, eISSN: 1844-7600, 2016;
151. Orha, C., Manea, F., Pop, A., Bandas, C., Lazau, C. TiO₂-nanostructured carbon composite sorbent/photocatalyst for humic acid removal from water, *DESALINATION AND WATER TREATMENT*, Volume: 57, Issue: 30, Pages: 14178-14187, ISSN: 1944-3994, eISSN: 1944-3986, 2016;
152. Osaci, M. The Neel Magnetic Relaxation Dynamics in Nanoparticle Systems - Phenomenological Approach versus Stochastic Approach, *ACTA PHYSICA POLONICA A*, Volume: 129, Issue: 3, Pages: 323-328, ISSN: 0587-4246, eISSN: 1898-794X, 2016;
153. Pacurariu, C., Paska, O., Ianos, R., Muntean, S.G. Effective removal of methylene blue from aqueous solution using a new magnetic iron oxide nanosorbent prepared by combustion synthesis, *CLEAN TECHNOLOGIES AND ENVIRONMENTAL POLICY*, Volume: 18, Issue: 3, Pages: 705-715, ISSN: 1618-954X, eISSN: 1618-9558, 2016;
154. Pasca, A., Ciugudean, M. Highly Efficient, Zero-Skew, Integrated Clock Distribution Networks Using Salphasic Principles, *ADVANCES IN ELECTRICAL AND COMPUTER ENGINEERING*, Volume: 16, Issue: 1, Pages: 69-78, ISSN: 1582-7445, eISSN: 1844-7600, 2016;
155. Pascariu, M.C., Rafaila, M., Medeleanu, M., Badea, V., Gruia, A.T., Purcarea, V.L., Penescu, M., Sisu, E. COMPUTATIONAL SEARCH FOR LONG BONDS IN RADICAL CATIONS OF SUGARS 1. GLUCOFURANOSE, GALACTOFURANOSE AND MANNOFURANOSE DI-O-ISOPROPYLIDENE DERIVATIVES, *FARMACIA*, Volume: 64, Issue: 4, Pages: 553-564, ISSN: 0014-8237, eISSN: 2065-0019, 2016;

156. Paul, C., Borza, P., Marcu, A., Rusu, G., Birdeanu, M., Zarcu, S.M., Peter, F. Influence of the Physico-chemical Characteristics of the Hybrid Matrix on the Catalytic Properties of Sol-gel Entrapped *Pseudomonas fluorescens* Lipase, *NANOMATERIALS AND NANOTECHNOLOGY*, Volume: 6, Article Number: 3, ISSN: 1847-9804, 2016;
157. Paulescu, M., Stefu, N., Calinoiu, D., Paulescu, E., Pop, N., Boata, R., Mares, O. Angstrom-Preccott equation: Physical basis, empirical models and sensitivity analysis, *RENEWABLE & SUSTAINABLE ENERGY REVIEWS*, Volume: 62, Pages: 495-506, ISSN: 1364-0321, 2016;
158. Pausescu, I., Medeleanu, M., Pop, R.O., Simon, Z., Costisor, O. A DFT STUDY ON 2-(HYDROXY-2-BENZYLIDENE)-CYCLOHEXANONE, *REVUE ROUMAINE DE CHIMIE*, Volume: 61, Issue: 8-9, Pages: 711-719, ISSN: 0035-3930, 2016;
159. Pentea, M., Sarac, I., Samfira, I., Negrea, A., Ciopec, M., Motoc, M., Gabor, A., Negrea, P., Buzatu, R. Studies Concerning Disposal Radionuclides by Adsorption Rabbit Bone Meal, *REVISTA DE CHIMIE*, Volume: 67, Issue: 5, Pages: 967-970, ISSN: 0034-7752, 2016;
160. Petrisor, C. Stabilization of a nonlinear control system on the Lie group $SO(3) \times R-3 \times R-3$, *JOURNAL OF NONLINEAR SCIENCES AND APPLICATIONS*, Volume: 9, Issue: 5, Pages: 2019-2030, ISSN: 2008-1898, eISSN: 2008-1901, 2016;
161. Petrovic, A., Lelea, D., Laza, I. The comparative analysis on using the NEPCM materials and nanofluids for microchannel cooling solutions, *INTERNATIONAL COMMUNICATIONS IN HEAT AND MASS TRANSFER*, Volume: 79, Pages: 39-45, ISSN: 0735-1933, eISSN: 1879-0178, 2016;
162. Pop, R., Medeleanu, M., van Staden, J., Diudea, M. Theoretical Studies Regarding the Aromaticity of Some Non-Planar Circulenes, *ZEITSCHRIFT FÜR PHYSIKALISCHE CHEMIE-INTERNATIONAL JOURNAL OF RESEARCH IN PHYSICAL CHEMISTRY & CHEMICAL PHYSICS*, Volume: 230, Issue: 2, Pages: 285-296, ISSN: 0942-9352, 2016;
163. Popa, S., Boran, S. Energetic Efficiency Calculation for a New Experimental Reactor, *MATERIALE PLASTICE*, Volume: 53, Issue: 3, Pages: 410-413, ISSN: 0025-5289, 2016;
164. Popa, S., Boran, S., Davidescu, C. Influence of Storage Conditions Upon CIELAB and Thermal Properties of Sesame Food Oil, *REVISTA DE CHIMIE*, Volume: 67, Issue: 7, Pages: 1290-1293, ISSN: 0034-7752, 2016;
165. Popa, S., Boran, S., Davidescu, C. Walnut Food Oil Under UV Radiation - influence Upon CIELAB and Thermal Properties of Antocyanin Addition, *REVISTA DE CHIMIE*, Volume: 67, Issue: 5, Pages: 858-861, ISSN: 0034-7752, 2016;
166. Popescu, T.C., Dumitrescu, C., Bordeasu, I. Aspects Concerning the Use of Plastics in Developing Test Stands for Experimental Models of Hydraulic Turbine Blades and Rotors, *MATERIALE PLASTICE*, Volume: 53, Issue: 1, Pages: 174-178, 2016;
167. Popov, D. SPIN COHERENT STATES DEFINED IN THE BARUT-GIRARDELLO MANNER, *PROCEEDINGS OF THE ROMANIAN ACADEMY SERIES A-MATHEMATICS PHYSICS TECHNICAL SCIENCES INFORMATION SCIENCE*, Volume: 17, Issue: 4, Pages: 328-335, ISSN: 1454-9069, 2016;
168. Popov, D., Negrea, R., Popov, M. Gazeau-Klauder coherent states examined from the viewpoint of diagonal ordering operation technique, *CHINESE PHYSICS B*, Volume: 25, Issue: 7, Article Number: 070301, ISSN: 1674-1056, eISSN: 1741-4199, 2016;
169. Popov, D., Popov, M. COHERENT STATES FOR CONTINUOUS SPECTRUM AS LIMITING CASE OF HYPERGEOMETRIC COHERENT STATES, *ROMANIAN REPORTS IN PHYSICS*, Volume: 68, Issue: 4, Pages: 1335-1348, ISSN: 1221-1451, eISSN: 1841-8759, 2016;
170. Potra, S., Izvercian, M., Miclea, S. Changes in CRM Approach: Refined Functional Blocks for Customer Creative Engagement in Services, *INTERNATIONAL JOURNAL OF INFORMATION SYSTEMS IN THE SERVICE SECTOR*, Volume: 8, Issue: 1, Pages: 45-57, ISSN: 1935-5688, eISSN: 1935-5696, 2016;
171. Racuciu, M., Iftode, C., Miclaus, S. A THERMAL MICROWAVE RADIATION AFFECTS THE GENETIC OF VEGETAL EMBRYOS, *ENVIRONMENTAL ENGINEERING AND MANAGEMENT JOURNAL*, Volume: 15, Issue: 12, Pages: 2561-2568, ISSN: 1582-9596, eISSN: 1843-3707, 2016;
172. Radac, M.B., Precup, R.E. Model-free constrained data-driven iterative reference input tuning algorithm with experimental validation, *INTERNATIONAL JOURNAL OF GENERAL SYSTEMS*, Volume: 45, Issue: 4, Pages: 455-476, ISSN: 0308-1079, eISSN: 1563-5104, 2016;
173. Radac, M.B., Precup, R.E. Three-level hierarchical model-free learning approach to trajectory tracking control, *ENGINEERING APPLICATIONS OF ARTIFICIAL INTELLIGENCE*, Volume: 55, Pages: 103-118, ISSN: 0952-1976, eISSN: 1873-6769, 2016;
174. Raduta, A., Nicoara, M., Locovei, C., Eckert, J., Stoica, M. Ti-based bulk glassy composites obtained by replacement of Ni with Ga, *INTERMETALLICS*, Volume: 69, Pages: 28-34, ISSN: 0966-9795, eISSN: 1879-0216, 2016;

175. Ramasamy, P., Stoica, M., Taghvaei, A.H., Prashanth, K.G., Kumar, R., Eckert, J. Kinetic analysis of the non-isothermal crystallization process, magnetic and mechanical properties of FeCoBSiNb and FeCoBSiNbCu bulk metallic glasses, *JOURNAL OF APPLIED PHYSICS*, Volume: 119, Issue: 7, Article Number: 073908, ISSN: 0021-8979, eISSN: 1089-7550, 2016;
176. Ramasamy, P., Szabo, A., Borzel, S., Eckert, J., Stoica, M., Bardos, A. High pressure die casting of Fe-based metallic glass, *SCIENTIFIC REPORTS*, Volume: 6, Article Number: 35258, PubMed ID: 27725780, ISSN: 2045-2322, 2016;
177. Roman, R.C., Radac, M.B., Precup, R.E. Multi-input-multi-output system experimental validation of model-free control and virtual reference feedback tuning techniques, *IET CONTROL THEORY AND APPLICATIONS*, Volume: 10, Issue: 12, Special Issue: SI, Pages: 1395-1403, ISSN: 1751-8644, eISSN: 1751-8652, 2016;
178. Roman, R.C., Radac, M.B., Precup, R.E., Petriu, E.M. Data-driven Model-Free Adaptive Control Tuned by Virtual Reference Feedback Tuning, *ACTA POLYTECHNICA HUNGARICA*, Volume: 1,3 Issue: 1, Special Issue: SI, Pages: 83-96, ISSN: 1785-8860, 2016;
179. Rost, U., Muntean, R., Marginean, G., Merino, C., Diez, R., Vaszilcsin, N., Brodmann, M. Effect of Process Parameters for Oxygen Plasma Activation of Carbon Nanofibers on the Characteristics of Deposited Platinum Nanoparticles as Electrocatalyst in Proton Exchange Membrane Fuel Cells, *INTERNATIONAL JOURNAL OF ELECTROCHEMICAL SCIENCE*, Volume: 11, Issue: 11, Pages: 9110-9122, ISSN: 1452-3981, 2016;
180. Sadowski, T., Craciun, E.M., Rabaea, A., Marsavina, L. Mathematical modeling of three equal collinear cracks in an orthotropic solid, *MECANICA*, Volume: 51, Issue: 2, Special Issue: SI, Pages: 329-339, ISSN: 0025-6455, eISSN: 1572-9648, 2016;
181. Sahebkar, A., Gurban, C., Serban, A., Andrica, F., Serban, M.C. Effects of supplementation with pomegranate juice on plasma C-reactive protein concentrations: A systematic review and meta-analysis of randomized controlled trials, *PHYTOMEDICINE*, Volume: 23, Issue: 11, Special Issue: SI, Pages: 1095-1102, PubMed ID: 26922037, ISSN: 0944-7113, eISSN: 1618-095X, 2016;
182. Sarac, B., Zhang, L., Kosiba, K., Pauly, S., Stoica, M., Eckert, J. Towards the Better: Intrinsic Property Amelioration in Bulk Metallic Glasses, *SCIENTIFIC REPORTS*, Volume: 6, Article Number: 27271, PubMed ID: 27273477, ISSN: 2045-2322, 2016;
183. Sarbu, I. A Study of Energy Optimisation of Urban Water Distribution Systems Using Potential Elements, *WATER*, Volume: 8, Issue: 12, Article Number: 593, ISSN: 2073-4441, 2016;
184. Sarbu, I., Ostafe, G. Optimal design of urban water supply pipe networks, *URBAN WATER JOURNAL*, Volume: 13, Issue: 5, Pages: 521-535, ISSN: 1573-062X, eISSN: 1744-9006, 2016;
185. Sarbu, I., Sebarchievici, C. Performance Evaluation of Radiator and Radiant Floor Heating Systems for an Office Room Connected to a Ground-Coupled Heat Pump, *ENERGIES*, Volume: 9, Issue: 4, Article Number: 228, ISSN: 1996-1073, 2016;
186. Segneanu, A.E., Damian, D., Hulka, I., Grozescu, I., Salifoglou, A. A simple and rapid method for calixarene-based selective extraction of bioactive molecules from natural products, *AMINO ACIDS*, Volume: 48, Issue: 3, Pages: 849-858, PubMed ID: 26597796, ISSN: 0939-4451, eISSN: 1438-2199, 2016;
187. Serban, D.A., Weissenborn, O., Geller, S., Marsavina, L., Gude, M. Evaluation of the mechanical and morphological properties of long fibre reinforced polyurethane rigid foams, *POLYMER TESTING*, Volume: 49, Pages: 121-127, ISSN: 0142-9418, eISSN: 1873-2348, 2016;
188. Sfirloaga, P., Malaescu, I., Poienar, M., Nicolae, M.C., Malaescu, D., Vlazan, P. Synthesis, structural and electrical properties of NaTaO₃:Cu, *JOURNAL OF MATERIALS SCIENCE-MATERIALS IN ELECTRONICS*, Volume: 27, Issue: 11, Pages: 11640-11645, ISSN: 0957-4522, eISSN: 1573-482X, 2016;
189. Shahabi, H.S., Scudino, S., Kaban, I., Stoica, M., Escher, B., Menzel, S., Vaughan, G.B.M., Kuhn, U., Eckert, J. Mapping of residual strains around a shear band in bulk metallic glass by nanobeam X-ray diffraction, *ACTA MATERIALIA*, Volume: 111, Pages: 187-193, ISSN: 1359-6454, eISSN: 1873-2453, 2016;
190. Simion, G., David, C., Gui, V., Caleanu, C.D. Fingertip-based Real Time Tracking and Gesture Recognition for Natural User Interfaces, *Acta Polytechnica Hungarica*, Volume: 13, Issue: 5, Pages: 189-204, ISSN: 1785-8860, 2016;
191. Slavici, T., Maris, S., Pirtea, M. Usage of artificial neural networks for optimal bankruptcy forecasting. Case study: Eastern European small manufacturing enterprises, *QUALITY & QUANTITY*, Volume: 50, Issue: 1, Pages: 385-398, ISSN: 0033-5177, eISSN: 1573-7845, 2016;

192. Socalici, A., Pascu, L., Ardelean, E., Heput, T., THE INFLUENCE OF CARBON, MANGANESE AND SILICON CONTENT UPON THE HARDNESS OF PHOSPHORUS CAST IRON USED IN MANUFACTURING ROLLING STOCK BRAKING SHOES, TEHNICKI VJESNIK-TECHNICAL GAZETTE, Volume: 23, Issue: 6, Pages: 1643-1648, ISSN: 1330-3651, eISSN: 1848-6339, 2016;
193. Socalici, A., Popa, E., Putan, V., Dragoi, F. RESEARCHES ON THE REDUCTION OF STEEL HYDROGEN CONTENT BY ITS SECONDARY TREATMENT INSIDE THE LADLE, TEHNICKI VJESNIK-TECHNICAL GAZETTE, Volume: 23, Issue: 5, Pages: 1381-1387, ISSN: 1330-3651, eISSN: 1848-6339, 2016;
194. Socalici, A.V., Ardelean, E., Crisan, E., Heput, T. RESEARCH ON INCREASING THE REACTION SURFACE OF SELF-REDUCING BRIQUETTES, ENVIRONMENTAL ENGINEERING AND MANAGEMENT JOURNAL, Volume: 15, Issue: 2, Pages: 443-451, ISSN: 1582-9596, eISSN: 1843-3707, 2016;
195. Socalici, A.V., Ardelean, E., Strugariu, M.L. RESEARCH ON SUSTAINABLE USE OF POWDERY WASTE, ENVIRONMENTAL ENGINEERING AND MANAGEMENT JOURNAL, Volume: 15, Issue: 1, Pages: 207-212, ISSN: 1582-9596, eISSN: 1843-3707, 2016;
196. Sopu, D., Foroughi, A., Stoica, M., Eckert, J. Brittle-to-Ductile Transition in Metallic Glass Nanowires, NANO LETTERS, Volume: 16, Issue: 7, Pages: 4467-4471, PubMed ID: 27248329, ISSN: 1530-6984, eISSN: 1530-6992, 2016;
197. Sopu, D., Soyarslan, C., Sarac, B., Bargmann, S., Stoica, M., Eckert, J. Structure-property relationships in nanoporous metallic glasses, ACTA MATERIALIA, Volume: 106, Pages: 199-207, ISSN: 1359-6454, eISSN: 1873-2453, 2016;
198. Sosdean, C., Marsavina, L., De Schutter, G. Experimental and numerical determination of the chloride penetration in cracked mortar specimens, EUROPEAN JOURNAL OF ENVIRONMENTAL AND CIVIL ENGINEERING, Volume: 20, Issue: 2, Pages: 231-249, ISSN: 1964-8189, eISSN: 2116-7214, 2016;
199. Stanciu, E.M., Pascu, A., Tiorean, M.H., Voiculescu, I., Roata, I.C., Croitoru, C., Hulka, I. Dual Coating Laser Cladding of NiCrBSi and Inconel 718, MATERIALS AND MANUFACTURING PROCESSES, Volume: 31, Issue: 12, Pages: 1556-1564, ISSN: 1042-6914, eISSN: 1532-2475, 2016;
200. Stangaciu, V., Micea, M., Cretu, V. MAC-Level Communication Time Modeling and Analysis for Real-Time WSNs, ADVANCES IN ELECTRICAL AND COMPUTER ENGINEERING, Volume: 16, Issue: 1, Pages: 35-40, ISSN: 1582-7445, eISSN: 1844-7600, 2016;
201. Stefan, O., Codrean, A., Dragomir, T.L. On the Robustness of Networked Control Systems with Quality of Service Adaptation Co-design, CONTROL ENGINEERING AND APPLIED INFORMATICS, Volume: 18, Issue: 4, Pages: 57-64, ISSN: 1454-8658, 2016;
202. Stefu, N., Paulescu, M., Blaga, R., Calinoiu, D., Pop, N., Boata, R., Paulescu, E. A theoretical framework for Angstrom equation. Its virtues and liabilities in solar energy estimation, ENERGY CONVERSION AND MANAGEMENT, Volume: 112, Pages: 236-245, ISSN: 0196-8904, eISSN: 1879-2227, 2016;
203. Stoia, M., Istratie, R., Pacurariu, C. Investigation of magnetite nanoparticles stability in air by thermal analysis and FTIR spectroscopy, JOURNAL OF THERMAL ANALYSIS AND CALORIMETRY, Volume: 125, Issue: 3, Pages: 1185-1198, ISSN: 1388-6150, eISSN: 1572-8943, 2016;
204. Stoia, M., Pacurariu, C., Istratie, R., Barvinschi, P., Locovei, C. Thermoanalytical techniques Excellent tools for the characterization of ferrite/SiO₂ nanocomposites and their precursors, JOURNAL OF THERMAL ANALYSIS AND CALORIMETRY, Volume: 125, Issue: 3, Pages: 1249-1263, ISSN: 1388-6150, eISSN: 1572-8943, 2016;
205. Stoia, M., Tamas, A., Rusu, G., Morosanu, J. SYNTHESIS OF MAGNETIC IRON OXIDES FROM FERROUS SULFATE AND SUBSTITUTES AMINES, STUDIA UNIVERSITATIS BABES-BOLYAI CHEMIA, Volume: 61, Issue: 4, Pages: 147-162, ISSN: 1224-7154, 2016;
206. Suci, L., Cristescu, C., Topirceanu, A., Udrescu, L., Udrescu, M., Buda, V., Tomescu, M.C., Evaluation of patients diagnosed with essential arterial hypertension through network analysis, IRISH JOURNAL OF MEDICAL SCIENCE, Volume: 185, Issue: 2, Pages: 443-451, PubMed ID: 26318328, ISSN: 0021-1265, eISSN: 1863-4362, 2016;
207. Susan-Resiga, D., Vekas, L. Ferrofluid-based magnetorheological fluids: tuning the properties by varying the composition at two hierarchical levels, RHEOLOGICA ACTA, Volume: 55, Issue: 7, Pages: 581-595, ISSN: 0035-4511, eISSN: 1435-1528, 2016;
208. Susan-Resiga, R.F., Muntean, S., Stuparu, A., Bosioc, A.I., Tanasa, C., Ighisan, C. A variational model for swirling flow states with stagnant region, EUROPEAN JOURNAL OF MECHANICS B-FLUIDS, Volume: 55, Pages: 104-115, ISSN: 0997-7546, eISSN: 1873-7390, 2016;

209. Svera, P., Racu, A.V., Mosoarca, C., Ursu, D., Linul, P.A., Baies, R., Banica, R. Influence of precursor crystallinity on photocatalytic activity of PdS/CdS-ZnS, *JOURNAL OF OPTOELECTRONICS AND ADVANCED MATERIALS*, Volume: 18, Issue: 11-12, Pages: 1027-1032, ISSN: 1454-4164, eISSN: 1841-7132, 2016;
210. Szuhaneck, R., Flaser, T., Maris, S., Szuhaneck, C. Risk Modeling in Plastics Processing for the Health System, *MATERIALE PLASTICE*, Volume: 53, Issue: 1, Pages: 73-75, ISSN: 0025-5289, 2016;
211. Tamas, A., Padure, M., Vincze, M. Rheological Behaviour of Fracturing Fluids Containing Surfactants, *REVISTA DE CHIMIE*, Volume: 67, Issue: 2, Pages: 344-348, ISSN: 0034-7752, 2016;
212. Tekle-Rottering, A., Jewell, K.S., Reisz, E., Lutze, H.V., Ternes, T.A., Schmidt, W., Schmidt, T.C. Ozonation of piperidine, piperazine and morpholine: Kinetics, stoichiometry, product formation and mechanistic considerations, *WATER RESEARCH*, Volume: 88, Pages: 960-971, PubMed ID: 26624229, ISSN: 0043-1354, 2016;
213. Tekle-Rottering, A., Reisz, E., Jewell, K.S., Lutze, H.V., Ternes, T.A., Schmidt, W., Schmidt, T.C. Ozonation of pyridine and other N-heterocyclic aromatic compounds: Kinetics, stoichiometry, identification of products and elucidation of pathways, *WATER RESEARCH*, Volume: 102, Pages: 582-593, PubMed ID: 27448509, ISSN: 0043-1354, 2016;
214. Tekle-Rottering, A., von Sonntag, C., Reisz, E., vom Eyser, C., Lutze, H.V., Turk, J., Naumov, S., Schmidt, W., Schmidt, T.C. Ozonation of anilines: Kinetics, stoichiometry, product identification and elucidation of pathways, *WATER RESEARCH*, Volume: 98, Pages: 147-159, PubMed ID: 27088249, ISSN: 0043-1354, 2016;
215. Tigan, G., Constantinescu, D. Bifurcations in a family of Hamiltonian systems and associated nontwist cubic maps, *CHAOS SOLITONS & FRACTALS*, Volume: 91, Pages: 128-135, ISSN: 0960-0779, eISSN: 1873-2887, 2016;
216. Tigan, G., Llibre, J. Heteroclinic, Homoclinic and Closed Orbits in the Chen System, *INTERNATIONAL JOURNAL OF BIFURCATION AND CHAOS*, Volume: 26, Issue: 4, Article Number: 1650072, ISSN: 0218-1274, eISSN: 1793-6551, 2016;
217. Tiwari, A.K., Albulescu, C.T. Oil price and exchange rate in India: Fresh evidence from continuous wavelet approach and asymmetric, multi-horizon Granger-causality tests, *APPLIED ENERGY*, Volume: 179, Pages: 272-283, ISSN: 0306-2619, eISSN: 1872-9118, 2016;
218. Tiwari, A.K., Albulescu, C.T. Renewable-to-total electricity consumption ratio: Estimating the permanent or transitory fluctuations based on flexible Fourier stationarity and unit root tests, *RENEWABLE & SUSTAINABLE ENERGY REVIEWS*, Volume: 57, Pages: 1409-1427, ISSN: 1364-0321, 2016;
219. Tiwari, A.K., Albulescu, C.T., Gupta, R. Time-frequency relationship between US output with commodity and asset prices, *APPLIED ECONOMICS*, Volume: 48, Issue: 3, Pages: 227-242, ISSN: 0003-6846, eISSN: 1466-4283, 2016;
220. Tiwari, A.K., Kyophilavong, P., Albulescu, C.T. Testing the stationarity of CO2 emissions series in Sub-Saharan African countries by incorporating nonlinearity and smooth breaks, *RESEARCH IN INTERNATIONAL BUSINESS AND FINANCE*, Volume: 37, Pages: 527-540, ISSN: 0275-5319, eISSN: 1878-3384, 2016;
221. Tiwari, A.K., Mutascu, M.I., Albulescu, C.T. Continuous wavelet transform and rolling correlation of European stock markets, *INTERNATIONAL REVIEW OF ECONOMICS & FINANCE*, Volume: 42, Pages: 237-256, ISSN: 1059-0560, eISSN: 1873-8036, 2016;
222. Tokar, A., Negoitescu, A., Hamat, C., Rosu, S. Chemical and Ecological State Evaluation of a Storage Lake, *REVISTA DE CHIMIE*, Volume: 67, Issue: 9, Pages: 1860-1863, ISSN: 0034-7752, 2016;
223. Topirceanu, A., Duma, A., Udrescu, M. Uncovering the fingerprint of online social networks using a network motif based approach, *COMPUTER COMMUNICATIONS*, Volume: 73, Special Issue: SI, Pages: 167-175, ISSN: 0140-3664, eISSN: 1873-703X, 2016;
224. Totorean, A.F., Bernad, S.I., Susan-Resiga, R.F. Fluid dynamics in helical geometries with applications for by-pass grafts, *APPLIED MATHEMATICS AND COMPUTATION*, Volume: 272, Pages: 604-613, ISSN: 0096-3003, eISSN: 1873-5649, 2016;
225. Udrescu, L., Sbarcea, L., Topirceanu, A., Iovanovici, A., Kurunczi, L., Bogdan, P., Udrescu, M. Clustering drug-drug interaction networks with energy model layouts: community analysis and drug repurposing, *SCIENTIFIC REPORTS*, Volume: 6, Article Number: 32745, PubMed ID: 27599720, ISSN: 2045-2322, 2016;

226. Ungureanu, V., Madeo, A., Zagari, G., Zucco, G., Dubina, D., Zinno, R. Koiter Asymptotic Analysis of Thin-walled Cold-formed Steel Uprights Pallet Racks, *STRUCTURES*, Volume: 8, Pages: 286-299, ISSN: 2352-0124, 2016;
227. Unlusayin, M., Hadaruga, N.G., Rusu, G., Gruia, A.T., Paunescu, V., Hadaruga, D.I. Nano-encapsulation competitiveness of omega-3 fatty acids and correlations of thermal analysis and Karl Fischer water titration for European anchovy (*Engraulis encrasicolus* L.) oil/beta-cyclodextrin complexes, *LWT-FOOD SCIENCE AND TECHNOLOGY*, Volume: 68, Pages: 135-144, ISSN: 0023-6438, eISSN: 1096-1127, 2016;
228. Urechescu, H., Pricop, M., Bogdan, L., Nes, C.S., Pricop, C., Rusu, L.C., Ravis, M. Experimental Compression and Traction Tests on Heat - Cured PMMA Used in Maxillary Obturator Prostheses, *MATERIALE PLASTICE*, Volume: 53, Issue: 1, Pages: 76-78, ISSN: 0025-5289, 2016;
229. Ursu, D., Vaszilcsin, N., Banica, R., Miclau, M. Effect of Al Doping on Performance of CuGaO₂ p-Type Dye-Sensitized Solar Cells, *JOURNAL OF MATERIALS ENGINEERING AND PERFORMANCE*, Volume: 25, Issue: 1, Pages: 59-63, ISSN: 1059-9495, eISSN: 1544-1024, 2016;
230. Utu, I.D., Mitelea, I., Urgan, S.D., Craciunescu, C.M., Transformation and Precipitation Reactions by Metal Active Gas Pulsed Welded Joints from X2CrNiMoN22-5-3 Duplex Stainless Steels, *MATERIALS*, Volume: 9, Issue: 7, Article Number: 606, ISSN: 1996-1944, 2016;
231. Vacha, J., Kyzlik, P., Both, I., Wald, F. Beams with corrugated web at elevated temperature, analytical and numerical models for heat transfer, *FIRE SAFETY JOURNAL*, Volume: 86, Pages: 83-94, ISSN: 0379-7112, eISSN: 1873-7226, 2016
232. Vaida, M., Duteanu, N., Grozescu, I. The effects of doping on the structural, optical and electric properties of Zn₄Sb₃ material, *JOURNAL OF THE SERBIAN CHEMICAL SOCIETY*, Volume: 81, Issue: 3, Pages: 323-332, ISSN: 0352-5139, 2016;
233. Vancea, C., Mosoarca, G., Negrea, A., Latia, A., Jurca, R.M. NEW GLASS-CERAMIC MATRIX FOR THE CHROMIUM WASTES IMMOBILIZATION, *REVISTA ROMANA DE MATERIALE-ROMANIAN JOURNAL OF MATERIALS*, Volume: 46, Issue: 3, Pages: 296-302, ISSN: 1583-3186, 2016;
234. Varga, L., Cioabla, A.E., Ionel, I. Comparative Determination of Cofermentation Using Residual Waters for Biogas Production at Small Scale, *REVISTA DE CHIMIE*, Volume: 67, Issue: 1, Pages: 174-176, ISSN: 0034-7752, 2016;
235. Vilceanu, C.B., Herban, I.S., Grecea, C. GEODETIC STUDIES WITH SIGNIFICANT CONTRIBUTION TO LANDSLIDE MONITORING IN SOUTH-WESTERN ROMANIA - AREA WITH HIGH RISK POTENTIAL, *TEHNICKI VJESNIK-TECHNICAL GAZETTE*, Volume: 23, Issue: 6, Pages: 1623-1630, ISSN: 1330-3651, eISSN: 1848-6339, 2016;
236. Vintila, T., Negrea, A., Barbu, H., Sumalan, R., Kovacs, K. Metal distribution in the process of lignocellulosic ethanol production from heavy metal contaminated sorghum biomass, *JOURNAL OF CHEMICAL TECHNOLOGY AND BIOTECHNOLOGY*, Volume: 91, Issue: 6, Pages: 1607-1614, ISSN: 0268-2575, eISSN: 1097-4660, 2016;
237. Voda, R., Lupa, L., Negrea, A., Ciopec, M., Negrea, P., Davidescu, C.M. The development of a new efficient adsorbent for the removal of methylene blue, *SEPARATION SCIENCE AND TECHNOLOGY*, Volume: 51, Issue: 15-16, Special Issue: SI, Pages: 2511-2518, ISSN: 0149-6395, eISSN: 1520-5754, 2016;
238. Wachter, A., Ionel, I., Wachter, R., Varga, L.A., Negrea, A., Minzatu, V., Muntean, C., Ciopec, M. ENCAPSULATION OF MUNICIPAL SOLID WASTE INCINERATION RESIDUES INTO COAL FLY ASH ROCK MATRIX, *JOURNAL OF ENVIRONMENTAL PROTECTION AND ECOLOGY*, Volume: 17, Issue: 3, Pages: 1037-1047, ISSN: 1311-5065, 2016;
239. Wachter, A., Wachter, R., Ionel, I., Vaida, D. ENERGY RECOVERY FROM ORGANIC WASTE, *UNIVERSITY POLITEHNICA OF BUCHAREST SCIENTIFIC BULLETIN SERIES C-ELECTRICAL ENGINEERING AND COMPUTER SCIENCE*, Volume: 78, Issue: 4, Pages: 267-276, ISSN: 2286-3540, eISSN: 2286-3559, 2016;
240. Zagari, G., Zucco, G., Madeo, A., Ungureanu, V., Zinno, R., Dubina, D. Evaluation of the erosion of critical buckling load of cold-formed steel members in compression based on Koiter asymptotic analysis, *THIN-WALLED STRUCTURES*, Volume: 108, Pages: 193-204, ISSN: 0263-8231, eISSN: 1879-3223, 2016;

Papers in ISI Proceedings

1. Albu, A. Logical Inference Modeled by Petri Nets, 2016 IEEE 11TH INTERNATIONAL SYMPOSIUM ON APPLIED COMPUTATIONAL INTELLIGENCE AND INFORMATICS (SACI) Pages: 137-140, 11th IEEE International Symposium on Applied Computational Intelligence and Informatics (SACI), MAY 12-14, 2016, Timisoara, ROMANIA, ISBN: 978-1-5090-2380-6, Published: 2016;
2. Albulescu, C.T., Draghici, A., Fistis, G.M., Trusculescu, A. Does ISO 9001 Quality Certification Influence Labor Productivity in EU-27?, 13TH INTERNATIONAL SYMPOSIUM IN MANAGEMENT: MANAGEMENT DURING AND AFTER THE ECONOMIC CRISIS, Book Series: Procedia Social and Behavioral Sciences, Volume: 221, Pages: 278-286, 13th International Symposium in Management - Management During and after the Economic Crisis (SIM), OCT 09-10, 2015, Timisoara, ROMANIA, ISSN: 1877-0428, Published: 2016;
3. Albulescu, C.T., Miclea, S., Tamasila, M., Taucean, I.M. THE WORKING CAPITAL AND LIQUIDITY'S ROLE IN EXPLAINING THE ITALIANS' FIRMS PROFITABILITY AROUND THE RECENT FINANCIAL CRISIS, FROM MANAGEMENT OF CRISIS TO MANAGEMENT IN A TIME OF CRISIS, Book Series: Review of Management and Economic Engineering International Management Conference, Pages: 129-139, 5th Review of Management and Economic Engineering International Management Conference, SEP 22-24, 2016, Tech Univ Cluj Napoca, Cluj Napoca, ROMANIA, ISSN: 2247-8639, Published: 2016;
4. Albulescu, C.T., Tamasila, M., Taucean, I.M. Entrepreneurship, Tax Evasion and Corruption in Europe, 13TH INTERNATIONAL SYMPOSIUM IN MANAGEMENT: MANAGEMENT DURING AND AFTER THE ECONOMIC CRISIS, Book Series: Procedia Social and Behavioral Sciences, Volume: 221, Pages: 246-253, 13th International Symposium in Management - Management During and after the Economic Crisis (SIM), OCT 09-10, 2015, Timisoara, ROMANIA, ISSN: 1877-0428, Published: 2016;
5. Alexa, V., Ratiu, S., Kiss, I. Metal rolling - Asymmetrical rolling process, INTERNATIONAL CONFERENCE ON APPLIED SCIENCES 2015 (ICAS2015), Book Series: IOP Conference Series-Materials Science and Engineering, Volume: 106, Article Number: 012019, International Conference on Applied Sciences (ICAS), JUN 03-05, 2015, Military Econ Acad Wuhan, Wuhan, PEOPLES R CHINA, ISSN: 1757-8981, Published: 2016;
6. Amaricai, A., Boncalo, O. Cost Effective FPGA Implementation for Hard Decision LDPC Decoders, 2016 24TH TELECOMMUNICATIONS FORUM (TELFOR), Pages: 246-249, 24th Telecommunications Forum (TELFOR), NOV 22-23, 2016, Belgrade, SERBIA, ISBN: 978-1-5090-4086-5, Published: 2016;
7. Ancuti, C. Ancuti, C.O. LAPLACIAN-GUIDED IMAGE DECOLORIZATION, 2016 IEEE INTERNATIONAL CONFERENCE ON IMAGE PROCESSING (ICIP), Book Series: IEEE International Conference on Image Processing ICIP, Pages: 4107-4111, 23rd IEEE International Conference on Image Processing (ICIP), SEP 25-28, 2016, Phoenix, AZ, ISSN: 1522-4880, ISBN: 978-1-4673-9961-6, Published: 2016;
8. Ancuti, C., Ancuti, C.O., De Vleeschouwer, C. D-HAZY: A DATASET TO EVALUATE QUANTITATIVELY DEHAZING ALGORITHMS, 2016 IEEE INTERNATIONAL CONFERENCE ON IMAGE PROCESSING (ICIP), Book Series: IEEE International Conference on Image Processing ICIP, Pages: 2226-2230, 23rd IEEE International Conference on Image Processing (ICIP), SEP 25-28, 2016, Phoenix, AZ, ISSN: 1522-4880, ISBN: 978-1-4673-9961-6, Published: 2016;
9. Ancuti, C., Ancuti, C.O., De Vleeschouwer, C., Bovik, A.C. NIGHT-TIME DEHAZING BY FUSION, 2016 IEEE INTERNATIONAL CONFERENCE ON IMAGE PROCESSING (ICIP), Book Series: IEEE International Conference on Image Processing ICIP, Pages: 2256-2260, 23rd IEEE International Conference on Image Processing (ICIP), SEP 25-28, 2016, Phoenix, AZ, ISSN: 1522-4880, ISBN: 978-1-4673-9961-6, Published: 2016;
10. Ancuti, C.O. Variational Segmentation under Variable Illumination Conditions, PROCEEDINGS OF ELMAR 2016 - 58TH INTERNATIONAL SYMPOSIUM ELMAR 2016 Book Series: ELMAR Proceedings, Pages: 217-220, 58th ELMAR International Symposium, SEP 12-14, 2016, Zadar, CROATIA, ISSN: 1334-2630, ISBN: 978-9-5318-4221-1, Published: 2016;
11. Andone, D., Vasii, R. MOOCs in Higher Education-Flipped Classroom or a New Smart Learning Model?, STATE-OF-THE-ART AND FUTURE DIRECTIONS OF SMART LEARNING, Book Series: Lecture Notes in Educational Technology, Pages: 303-307, 2nd International Conference on Smart Learning Environments (ICSOLE), SEP 23-25, 2015, Univ Craiova, Sinaia, ROMANIA, ISSN: 2196-4963, ISBN: 978-981-287-868-7; 978-981-287-866-3, Published: 2016;
12. Andreescu, I., Gaivoronsch, V., Mosoarca, M. Old and New - the Complex Problem of Integrating New Functions into Old Building, WORLD MULTIDISCIPLINARY CIVIL ENGINEERING-ARCHITECTURE-URBAN PLANNING SYMPOSIUM 2016, WMCAUS 2016, Book Series: Procedia Engineering, Volume: 161, Pages: 1103-1108, World Multidisciplinary Civil Engineering-Architecture-Urban Planning Symposium (WMCAUS), JUN 13-17, 2016, Prague, CZECH REPUBLIC, ISSN: 1877-7058, Published: 2016;

13. Andreescu, I., Keller, A., Mosoarca, M. Complex Assessment of Roof Structures, WORLD MULTIDISCIPLINARY CIVIL ENGINEERING-ARCHITECTURE-URBAN PLANNING SYMPOSIUM 2016, WMCAUS 2016, Book Series: Procedia Engineering, Volume: 161, Pages: 1204-1210, World Multidisciplinary Civil Engineering-Architecture-Urban Planning Symposium (WMCAUS), JUN 13-17, 2016, Prague, CZECH REPUBLIC, ISSN: 1877-7058, Published: 2016;
14. Ardelean, E., Lascutoni, A., Ardelean, M., Socalici, A., Heput, T. Simulation of solidification process for billet with phi 350mm section, continuous casted, INTERNATIONAL CONFERENCE ON APPLIED SCIENCES 2015 (ICAS2015), Book Series: IOP Conference Series-Materials Science and Engineering, Volume: 106, Article Number: 012034, International Conference on Applied Sciences (ICAS), JUN 03-05, 2015, Military Econ Acad Wuhan, Wuhan, PEOPLES R CHINA, ISSN: 1757-8981, Published: 2016;
15. Ardelean, M., Ardelean, E., Popa, E., Josan, A., Socalici, A. Research regarding to behavior on advanced plastic from rolling mills equipment, INTERNATIONAL CONFERENCE ON APPLIED SCIENCES 2015 (ICAS2015), Book Series: IOP Conference Series-Materials Science and Engineering, Volume: 106, Article Number: 012035, International Conference on Applied Sciences (ICAS), JUN 03-05, 2015, Military Econ Acad Wuhan, Wuhan, PEOPLES R CHINA, ISSN: 1757-8981, Published: 2016;
16. Argesanu, V., Kulcsar, R.M., Borozan, I.S., Jula, M., Streian, F., Farkas, A.Z., Sticlaru, C. Highlighting the maxillofacial trauma influence on posture by FEA modeling simulation, 2016 IEEE 14TH INTERNATIONAL SYMPOSIUM ON INTELLIGENT SYSTEMS AND INFORMATICS (SISY), Book Series: International Symposium on Intelligent Systems and Informatics, Pages: 129-133, IEEE 14th International Symposium on Intelligent Systems and Informatics (SISY), AUG 29-31, 2015, Subotica, SERBIA, ISSN: 1949-047X, ISBN: 978-1-5090-2866-5, Published 2016;
17. Armas, A., Man, E.T., Ienciu, A.A., Cuzic, O.S., Beilicci, R.F. DROUGHT AS CLIMATE RISK IN TIMIS COUNTY, ROMANIA, WATER, RESOURCES, FOREST, MARINE AND OCEAN ECOSYSTEMS CONFERENCE PROCEEDINGS, VOL I, Book Series: International Multidisciplinary Scientific GeoConference-SGEM, Pages: 251-258, 16th International Multidisciplinary Scientific Geoconference (SGEM 2016), JUN 30-JUL 06, 2016, Albena, BULGARIA, ISSN: 1314-2704, ISBN: 978-619-7105-61-2, Published: 2016;
18. Armas, A., Man, T.E., Cuzic, O.S. Geodesical Measurements in the Global Positioning System, MODERN TECHNOLOGIES FOR THE 3RD MILLENNIUM, Pages: 1-6, 15th National Technical-Scientific Conference on Modern Technologies for the 3rd Millennium, NOV 27-28, 2015, Oradea, ROMANIA, ISBN: 978-88-7587-724-8, Published: 2016;
19. Baba, M., Pescaru, D., Gui, V., Jian, I. Stray Dogs Behavior Detection in Urban Area Video Surveillance Streams, 2016 12TH IEEE INTERNATIONAL SYMPOSIUM ON ELECTRONICS AND TELECOMMUNICATIONS (ISETC'16), Pages: 313-316, 12th IEEE International Symposium on Electronics and Telecommunications (ISETC), OCT 27-28, 2016, Timisoara, ROMANIA, ISBN: 978-1-5090-3748-3, Published: 2016;
20. Baci, I., Cuntan, C.D., Floruta, M. Self-oscillating inverter with bipolar transistors, INTERNATIONAL CONFERENCE ON APPLIED SCIENCES 2015 (ICAS2015), Book Series: IOP Conference Series-Materials Science and Engineering, Volume: 106, Article Number: 012013, International Conference on Applied Sciences (ICAS), JUN 03-05, 2015, Military Econ Acad Wuhan, Wuhan, PEOPLES R CHINA, ISSN: 1757-8981, Published: 2016;
21. Badea, A., Prostean, G., Tamasila, M., Taucean, I. CONCEPTUAL MODEL IN SUPPLY CHAIN COLLABORATION FOR RENEWABLE ENERGY RESOURCES PROJECTS, FROM MANAGEMENT OF CRISIS TO MANAGEMENT IN A TIME OF CRISIS, Book Series: Review of Management and Economic Engineering International Management Conference, Pages: 66-73, 5th Review of Management and Economic Engineering International Management Conference, SEP 22-24, 2016, Tech Univ Cluj Napoca, Cluj Napoca, ROMANIA, ISSN: 2247-8639, Published: 2016;
22. Badea, C., Chendes, R., Bob, C., Dan, S. Recycling of Fly Ash and Dry Desulphurisation Residues from Timisoara Heat Station into Civil Construction Industry, MODERN TECHNOLOGIES FOR THE 3RD MILLENNIUM, Pages: 87-91, 15th National Technical-Scientific Conference on Modern Technologies for the 3rd Millennium, NOV 27-28, 2015, Oradea, ROMANIA, ISBN: 978-88-7587-724-8, Published: 2016;
23. Badea, C., Chendes, R., Iures, L., Dan, S. REUSE OF FLY ASH AND DESULPHURISATION RESIDUES INTO BUILDING MATERIALS, ENERGY AND CLEAN TECHNOLOGIES CONFERENCE PROCEEDINGS, SGEM 2016, VOL II, Book Series: International Multidisciplinary Scientific GeoConference-SGEM, Pages: 121-126, 16th International Multidisciplinary Scientific Geoconference (SGEM 2016), JUN 30-JUL 06, 2016, Albena, BULGARIA, ISSN: 1314-2704, ISBN: 978-619-7105-64-3, Published: 2016;

24. Badescu, S., Branea, A.M., Gaman, M.S. THE IMPORTANCE OF THE PUBLIC FACILITIES NETWORK WITHIN THE URBAN ENVIRONMENT AND ITS DISTRIBUTION WITHIN COLLECTIVE HOUSING NEIGHBORHOODS. CASE STUDY: TIMISOARA, ROMANIA, SGEM 2016, BK 4: ARTS, PERFORMING ARTS, ARCHITECTURE AND DESIGN CONFERENCE PROCEEDINGS, VOL III Book Series: International Multidisciplinary Scientific Conferences on Social Sciences and Arts, Pages: 507-514, 3rd International Multidisciplinary Scientific Conference on Social Sciences and Arts, SGEM 2016, AUG 24-30, 2016, Albena, BULGARIA, ISSN: 2367-5659, ISBN: 978-619-7105-78-0, Published: 2016;
25. Balabuc, C., Todea, C., Locovei, C., Raduta, A. SEM investigation of Er:YAG laser apical preparation, HIGH-END MEDICINE BASED ON LASER AND BIOTECHNOLOGIES, Book Series: Proceedings of SPIE, Volume: 9670, Article Number: 96700Q, 5th Congress of the World-Federation-for-Laser-Dentistry / 6th International Conference on Lasers in Medicine, MAY 07-09, 2015, Bucharest, ROMANIA, ISSN: 0277-786X, ISBN: 978-1-62841-893-4, Published: 2016;
26. Banescu, O.A., Hapenciu, A.D., Carjan, R. Ways of Successfully Integrating Traditional Concepts into the Present, WORLD MULTIDISCIPLINARY CIVIL ENGINEERING-ARCHITECTURE-URBAN PLANNING SYMPOSIUM 2016, WMCAUS 2016, Book Series: Procedia Engineering, Volume: 161, Pages: 1551-1555, World Multidisciplinary Civil Engineering-Architecture-Urban Planning Symposium (WMCAUS), JUN 13-17, 2016, Prague, CZECH REPUBLIC, ISSN: 1877-7058, Published: 2016;
27. Banius, O., The drawbacks of statement code coverage test case prioritization related to domain testing, 2016 IEEE 11TH INTERNATIONAL SYMPOSIUM ON APPLIED COMPUTATIONAL INTELLIGENCE AND INFORMATICS (SACI), Pages: 221-224, 11th IEEE International Symposium on Applied Computational Intelligence and Informatics (SACI), MAY 12-14, 2016, Timisoara, ROMANIA, ISBN: 978-1-5090-2380-6, Published: 2016;
28. Barbulescu, C., Kilyeni, S., Deacu, A., Turi, G.M., Moga, M. Artificial Neural Network based Monthly Load Curves Forecasting, 2016 IEEE 11TH INTERNATIONAL SYMPOSIUM ON APPLIED COMPUTATIONAL INTELLIGENCE AND INFORMATICS (SACI), Pages: 237-242, 11th IEEE International Symposium on Applied Computational Intelligence and Informatics (SACI), MAY 12-14, 2016, Timisoara, ROMANIA, ISBN: 978-1-5090-2380-6, Published: 2016;
29. Barz, C., Deaconu, S.I., Latinovic, T., Berdie, A., Pop-Vadean, A., Horgos, M. PLCs used in smart home control, INTERNATIONAL CONFERENCE ON APPLIED SCIENCES 2015 (ICAS2015), Book Series: IOP Conference Series-Materials Science and Engineering, Volume: 106, Article Number: 012036, International Conference on Applied Sciences (ICAS), JUN 03-05, 2015, Military Econ Acad Wuhan, Wuhan, PEOPLES R CHINA, ISSN: 1757-8981, Published: 2016;
30. Barz, C., Todea, C., Latinovic, T., Preradovic, D.M., Deaconu, S., Berdie, A. Intelligent traffic control system using PLC, INTERNATIONAL CONFERENCE ON INNOVATIVE IDEAS IN SCIENCE (IIS2015), Book Series: IOP Conference Series-Materials Science and Engineering, Volume: 144, Article Number: 012017, International Conference on Innovative Ideas in Science (IIS), NOV 12-13, 2015, Baia Mare, ROMANIA, ISSN: 1757-8981, Published: 2016;
31. Bechet, P., Miclaus, S., Miclaus, A., Balint, C. Experimental Analysis of Noise Level and Channels Availability for High Frequency OFDM Data Transmission in NVIS Propagation Conditions, PROCEEDINGS OF THE 2016 INTERNATIONAL SYMPOSIUM ON ELECTROMAGNETIC COMPATIBILITY - EMC EUROPE, Book Series: EMC Europe, Pages: 844-849, International Symposium on Electromagnetic Compatibility - EMC EUROPE, SEP 05-09, 2016, Wroclaw, POLAND, ISSN: 2325-0356, ISBN: 978-1-5090-1416-3, Published: 2016;
32. Beilicci, E., Beilicci, R., Visescu, M. STUDY OF FLOODING RISK AREAS USING 1D/2D ADVANCED HYDROINFORMATIC TOOLS, WATER, RESOURCES, FOREST, MARINE AND OCEAN ECOSYSTEMS CONFERENCE PROCEEDINGS, VOL I, Book Series: International Multidisciplinary Scientific GeoConference-SGEM, Pages: 675-681, 16th International Multidisciplinary Scientific Geoconference (SGEM 2016), JUN 30-JUL 06, 2016, Albena, BULGARIA, ISSN: 1314-2704, ISBN: 978-619-7105-61-2, Published: 2016;
33. Beiu, R.M., Mnerie, C., Duma, V.F. Analysis of Curved Shape Micro-mirrors For On-Chip Communication, ADVANCED TOPICS IN OPTOELECTRONICS, MICROELECTRONICS, AND NANOTECHNOLOGIES VIII, Book Series: Proceedings of SPIE, Volume: 10010, Article Number: UNSP 100101Y, 8th International Conference on Advanced Topics in Optoelectronics, Microelectronics, and Nanotechnologies (ATOM-N), SEP 25-28, 2016, Constanta, ROMANIA, ISSN: 0277-786X, ISBN: 978-1-5106-0424-7; 978-1-5106-0425-4, Published: 2016;
34. Belega, D., Macii, D., Petri, D. Power System Frequency Estimation Accuracy of Improved DFT-based Algorithms over Short Intervals, 2016 IEEE INTERNATIONAL WORKSHOP ON APPLIED MEASUREMENTS FOR POWER SYSTEMS (AMPS), Book Series: IEEE International Workshop on Applied Measurements for Power Systems, Pages: 43-48, 7th IEEE International Workshop on Applied Measurements for Power Systems (AMPS), SEP 28-30, 2016, Aachen, GERMANY, ISSN: 2473-1315, ISBN: 978-1-5090-2373-8, Published: 2016;

35. Belega, D., Pazsitka, R., Stoiciu, D. Measurement Experiments Performed Using the ASLK PRO Board, 2016 12TH IEEE INTERNATIONAL SYMPOSIUM ON ELECTRONICS AND TELECOMMUNICATIONS (ISETC'16), Pages: 162–+, 12th IEEE International Symposium on Electronics and Telecommunications (ISETC), OCT 27–28, 2016, Timisoara, ROMANIA, ISBN: 978-1-5090-3748-3, Published: 2016;
36. Belega, D., Petri, D. Weighted Least Squares Dynamic Synchrophasor Estimation in the Case of Harmonically Distorted Sine-waves, 2016 IEEE INTERNATIONAL INSTRUMENTATION AND MEASUREMENT TECHNOLOGY CONFERENCE PROCEEDINGS, Pages: 477–482, IEEE International Instrumentation and Measurement Technology Conference (I2MTC), MAY 23–26, 2016, Taipei, TAIWAN, ISBN: 978-1-4673-9220-4, Published: 2016;
37. Belega, D., Petri, D., Dallet, D. Influence of Wideband Noise on Sinusoid Parameter Estimation Provided by the Two-Point Interpolated Odd-DFT Algorithm, 2016 12TH IEEE INTERNATIONAL SYMPOSIUM ON ELECTRONICS AND TELECOMMUNICATIONS (ISETC'16), Pages: 293–297, 12th IEEE International Symposium on Electronics and Telecommunications (ISETC), OCT 27–28, 2016, Timisoara, ROMANIA, ISBN: 978-1-5090-3748-3, Published: 2016;
38. Belei, H., Căleanu, C.D., Embedded Radar Simulator, 2016 12TH IEEE INTERNATIONAL SYMPOSIUM ON ELECTRONICS AND TELECOMMUNICATIONS (ISETC'16), Pages: 33–36, 12th IEEE International Symposium on Electronics and Telecommunications (ISETC), OCT 27–28, 2016, Timisoara, ROMANIA, ISBN: 978-1-5090-3748-3, Published: 2016;
39. Bena, T., Mitelea, I., Bordeasu, I., Craciunescu, C. THE EFFECT OF THE SOFTENING ANNEALING AND OF NORMALIZING ON THE CAVITATION EROSION RESISTANCE OF NODULAR CAST IRON FGN 400-15, METAL 2016: 25TH ANNIVERSARY INTERNATIONAL CONFERENCE ON METALLURGY AND MATERIALS, Pages: 653–658, 25th Anniversary International Conference on Metallurgy and Materials (METAL), MAY 25–27, 2016, Brno, CZECH REPUBLIC, ISBN: 978-80-87294-67-3, Published: 2016;
40. Benea, M.L., Benea, L.P. Characterisation of the TiO₂ coatings deposited by plasma spraying, INTERNATIONAL CONFERENCE ON APPLIED SCIENCES 2015 (ICAS2015), Book Series: IOP Conference Series–Materials Science and Engineering, Volume: 106, Article Number: 012024, International Conference on Applied Sciences (ICAS), JUN 03–05, 2015, ISSN: 1757-8981, Published: 2016;
41. Benea, M.L., Benea, O.D. Mathematical modelling in Matlab of the experimental results shows the electrochemical potential difference – temperature of the WC coatings immersed in a NaCl solution, INTERNATIONAL CONFERENCE ON APPLIED SCIENCES 2015 (ICAS2015), Book Series: IOP Conference Series–Materials Science and Engineering, Volume: 106, Article Number: 012025, International Conference on Applied Sciences (ICAS), JUN 03–05, 2015, Military Econ Acad Wuhan, Wuhan, PEOPLES R CHINA, ISSN: 1757-8981, Published: 2016;
42. Bernad, S.I., Bosioc, A., Bernad, E.S., Petre, I., Totorean, A.F. Flow Characteristics in Narrowed Coronary Bypass Graft, PROCEEDINGS OF THE INTERNATIONAL CONFERENCE ON NUMERICAL ANALYSIS AND APPLIED MATHEMATICS 2015 (ICNAAM-2015), Book Series: AIP Conference Proceedings, Volume: 1738, Article Number: UNSP 030025, International Conference on Numerical Analysis and Applied Mathematics (ICNAAM), SEP 23–29, 2015, Rhodes, GREECE, ISSN: 0094-243X, ISBN: 978-0-7354-1392-4, Published: 2016;
43. Bernad, S.I., Totorean, A.F., Bosioc, A.I., Petre, I., Bernad, E.S. Stent Implantation Influence Wall Shear Stress Evolution, PROCEEDINGS OF THE INTERNATIONAL CONFERENCE ON NUMERICAL ANALYSIS AND APPLIED MATHEMATICS 2015 (ICNAAM-2015), Book Series: AIP Conference Proceedings, Volume: 1738, Article Number: UNSP 030027, International Conference on Numerical Analysis and Applied Mathematics (ICNAAM), SEP 23–29, 2015, Rhodes, GREECE, ISSN: 0094-243X, ISBN: 978-0-7354-1392-4, Published: 2016;
44. Biro, E., Bratiloveanu, G., Todea, A., Peter, F. Synthesis of galacto-oligosaccharides by immobilized beta-galactosidase using alkyl or aryl substituted silane precursors for efficient sol-gel entrapment, NEW BIOTECHNOLOGY, Meeting Abstract: P8-30, Volume: 33, Pages: S104-S104, ISSN: 1871-6784, eISSN: 1876-4347, Supplement: S, Published: JUL 25, 2016;
45. Bistran, D.A., Susan-Resiga, R.F. Efficient Proper Orthogonal Decomposition for Parameter Dependent Problems with Applications to Hydraulic Turbines, PROCEEDINGS OF THE INTERNATIONAL CONFERENCE ON NUMERICAL ANALYSIS AND APPLIED MATHEMATICS 2015 (ICNAAM-2015), Book Series: AIP Conference Proceedings, Volume: 1738, Article Number: 410002, International Conference on Numerical Analysis and Applied Mathematics (ICNAAM), SEP 23–29, 2015, Rhodes, GREECE, ISSN: 0094-243X, ISBN: 978-0-7354-1392-4, Published: 2016;
46. Bob, C., Chendes, R., Dencsak, T., Bob, L., Boros, I. THE ASSESSMENT OF TRANSPORTATION OF MATERIALS BY A SUSTAINABLE MODEL, ECOLOGY, ECONOMICS, EDUCATION AND LEGISLATION CONFERENCE PROCEEDINGS, SGEM 2016, VOL I, Book Series: International Multidisciplinary Scientific GeoConference-SGEM, Pages: 669–676, 16th International Multidisciplinary Scientific Geoconference (SGEM 2016), JUN 30–JUL 06, 2016, Albena, BULGARIA, ISSN: 1314-2704, ISBN: 978-619-7105-65-0, Published: 2016;

47. Bob, C., Leontiu, F.C. SUSTAINABILITY OF THE INTERVENTION FOR THE HYGROTHERMAL REHABILITATION OF A HISTORICAL BUILDING USING AN INNER HEAT INSULATION WITH AIRED LAYER, SGEM 2016, BK 4: ARTS, PERFORMING ARTS, ARCHITECTURE AND DESIGN CONFERENCE PROCEEDINGS, VOL III, Book Series: International Multidisciplinary Scientific Conferences on Social Sciences and Arts, Pages: 473-480, 3rd International Multidisciplinary Scientific Conference on Social Sciences and Arts, SGEM 2016, AUG 24-30, 2016, Albena, BULGARIA, ISSN: 2367-5659, ISBN: 978-619-7105-78-0, Published: 2016;
48. Bob, C., Leontiu, F.C., SUSTAINABILITY OF THE HYGROTHERMAL REHABILITATION OF A HISTORICAL BUILDING BY USING AN OUTER HEAT INSULATION WITH AIRED LAYER AND THE REPLICATION OF THE BORDERS, SGEM 2016, BK 4: ARTS, PERFORMING ARTS, ARCHITECTURE AND DESIGN CONFERENCE PROCEEDINGS, VOL III, Book Series: International Multidisciplinary Scientific Conferences on Social Sciences and Arts, Pages: 465-472, 3rd International Multidisciplinary Scientific Conference on Social Sciences and Arts, SGEM 2016, AUG 24-30, 2016, Albena, BULGARIA, ISSN: 2367-5659, ISBN: 978-619-7105-78-0, Published: 2016;
49. Bogdan, D., Bogdan, R., Popa, M. Delta Flashing of an ECU in the Automotive Industry, 2016 IEEE 11TH INTERNATIONAL SYMPOSIUM ON APPLIED COMPUTATIONAL INTELLIGENCE AND INFORMATICS (SACI), Pages: 503-507, 11th IEEE International Symposium on Applied Computational Intelligence and Informatics (SACI), MAY 12-14, 2016, Timisoara, ROMANIA, ISBN: 978-1-5090-2380-6, Published: 2016;
50. Bojan-Dragos, C.A., Precup, R.E., Preitl, S., Hergane, S., Hughiet, E.G., Szedlak-Stinean, A.I. Proportional-Integral Gain-Scheduling Control of a Magnetic Levitation System, 2016 20TH INTERNATIONAL CONFERENCE ON SYSTEM THEORY, CONTROL AND COMPUTING (ICSTCC), Book Series: International Conference on System Theory Control and Computing, Pages: 1-6, 20th International Conference on System Theory, Control and Computing (ICSTCC), OCT 13-15, 2016, Sinaia, ROMANIA, ISSN: 2372-1618, ISBN: 978-1-5090-2720-0, Published: 2016;
51. Bojan-Dragos, C.A., Precup, R.E., Preitl, S., Szedlak-Stinean, A.I., Petriu, E.M., Particle Swarm Optimization of Fuzzy Models for Electromagnetic Actuated Clutch Systems, PROCEEDINGS OF THE 18TH MEDITERRANEAN ELECTROTECHNICAL CONFERENCE MELECON 2016, Book Series: IEEE Mediterranean Electrotechnical Conference-MELECON, 18th Mediterranean Electrotechnical Conference (MELECON), APR 18-20, 2016, Limassol, CYPRUS, ISSN: 2158-8481, ISBN: 978-1-5090-0058-6, Published: 2016;
52. Bojan-Dragos, C.A., Preitl, S., Precup, R.E., Hergane, S., Hughiet, E.G., Szedlak-Stinean, A.I. State Feedback and Proportional-Integral-Derivative Control of a Magnetic Levitation System, 2016 IEEE 14TH INTERNATIONAL SYMPOSIUM ON INTELLIGENT SYSTEMS AND INFORMATICS (SISY), Book Series: International Symposium on Intelligent Systems and Informatics, Pages: 111-116, IEEE 14th International Symposium on Intelligent Systems and Informatics (SISY), AUG 29-31, 2015, Subotica, SERBIA, ISSN: 1949-047X, ISBN: 978-1-5090-2866-5, Published: 2016;
53. Boldea, I., Tutelea, L.N. PMSM with rotor PM mechanical flux-weakening (MFW) to zero for an 150kW, 600Vdc, 500-6000 rpm drive: preliminary design with key validation, 2016 XXII INTERNATIONAL CONFERENCE ON ELECTRICAL MACHINES (ICEM), Pages: 1995-2001, 22nd International Conference on Electrical Machines (ICEM), SEP 04-07, 2016, Lausanne, SWITZERLAND, ISBN: 978-1-5090-2538-1, Published: 2016;
54. Boncalo, O. QC-LDPC Gear-Like Decoder Architecture with Multi-Domain Quantization, 19TH EUROMICRO CONFERENCE ON DIGITAL SYSTEM DESIGN (DSD 2016), Pages: 244-251, 19th Euromicro Conference on Digital System Design (DSD), AUG 31-SEP 02, 2016, Limassol, CYPRUS, ISBN: 978-1-5090-2816-0, Published: 2016;
55. Boncalo, O., Mot, I. Multi Clock Flooded LDPC Decoding Architecture with Reduced Memory and Interconnect, 2016 IEEE Computer Society Annual Symposium on VLSI (ISVLSI), Book Series: IEEE Computer Society Annual on VLSI, Pages: 697-700, IEEE-Computer-Society Annual Symposium on VLSI (ISVLSI), JUL 11-13, 2016, Pittsburgh, PA, Published: 2016;
56. Bordeasu, I., Popoviciu, M.O., Mitelea, I., Micu, L.M., Bordeasu, C., Ghera, C., Iosif, A. Researches upon cavitation erosion behavior of some duplex steels, INTERNATIONAL CONFERENCE ON APPLIED SCIENCES 2015 (ICAS2015), Book Series: IOP Conference Series-Materials Science and Engineering, Volume: 106, Article Number: 012032, International Conference on Applied Sciences (ICAS), JUN 03-05, 2015, Military Econ Acad Wuhan, Wuhan, PEOPLES R CHINA, ISSN: 1757-8981, Published: 2016;
57. Bordeasu, I., Popoviciu, M.O., Mitelea, I., Salcianu, L.C., Bordeasu, D., Duma, S.T., Iosif, A. Researches upon the cavitation erosion behaviour of austenite steels, INTERNATIONAL CONFERENCE ON APPLIED SCIENCES 2015 (ICAS2015), Book Series: IOP Conference Series-Materials Science and Engineering, Volume: 106, Article Number: 012001, International Conference on Applied Sciences (ICAS), JUN 03-05, 2015, Military Econ Acad Wuhan, Wuhan, PEOPLES R CHINA, ISSN: 1757-8981, Published: 2016;

58. Borlea, I.D., Precup, R.E., Dragan, F. On the Architecture of a Clustering Platform for the Analysis of Big Volumes of Data, 2016 IEEE 11TH INTERNATIONAL SYMPOSIUM ON APPLIED COMPUTATIONAL INTELLIGENCE AND INFORMATICS (SACI), Pages: 145-150, 11th IEEE International Symposium on Applied Computational Intelligence and Informatics (SACI), MAY 12-14, 2016, Timisoara, ROMANIA, ISBN: 978-1-5090-2380-6, Published: 2016;
59. Bosioc, A.I., Tanasa, C. Experimental and Numerical Investigation of a Draft Tube Cone at Lower Runner Speeds, PROCEEDINGS OF THE INTERNATIONAL CONFERENCE ON NUMERICAL ANALYSIS AND APPLIED MATHEMATICS 2015 (ICNAAM-2015), Book Series: AIP Conference Proceedings, Volume: 1738, Article Number: 030019, International Conference on Numerical Analysis and Applied Mathematics (ICNAAM), SEP 23-29, 2015, Rhodes, GREECE, ISSN: 0094-243X, ISBN: 978-0-7354-1392-4, Published: 2016;
60. Bota, A., Bota, D. What means external prestressing for an old Gerber structure, BRIDGES IN DANUBE BASIN 2016 - NEW TRENDS IN BRIDGE ENGINEERING AND EFFICIENT SOLUTION FOR LARGE AND MEDIUM SPAN BRIDGES, Book Series: Procedia Engineering, Volume: 156, Pages: 48-53, 9th International Conference on Bridges in Danube Basin, SEP 30-OCT 01, 2016, Zilina, SLOVAKIA, ISSN: 1877-7058, Published: 2016;
61. Bota, A., Sarbu, I., Bota, D., Tecsa, A. Conceptual Particularities of the Bridge Structure over the Crisul Alb River in the Town Brad, MODERN TECHNOLOGIES FOR THE 3RD MILLENNIUM, Pages: 81-86, 15th National Technical-Scientific Conference on Modern Technologies for the 3rd Millennium, NOV 27-28, 2015, Oradea, ROMANIA, ISBN: 978-88-7587-724-8, Published: 2016;
62. Bota, A., Tecsa, A., Bota, D. Centenary Traian Bridge of Timisoara, rehabilitated and neglected, BRIDGES IN DANUBE BASIN 2016 - NEW TRENDS IN BRIDGE ENGINEERING AND EFFICIENT SOLUTION FOR LARGE AND MEDIUM SPAN BRIDGES, Book Series: Procedia Engineering, Volume: 156, Pages: 54-61, 9th International Conference on Bridges in Danube Basin, SEP 30-OCT 01, 2016, Zilina, SLOVAKIA, ISSN: 1877-7058, Published: 2016;
40. Benea, M.L., Benea, L.P. Characterisation of the TiO₂ coatings deposited by plasma spraying, INTERNATIONAL CONFERENCE ON APPLIED SCIENCES 2015 (ICAS2015), Book Series: IOP Conference Series-Materials Science and Engineering, Volume: 106, Article Number: 012024, International Conference on Applied Sciences (ICAS), JUN 03-05, 2015, ISSN: 1757-8981, Published: 2016;
63. Botoca, C., Botoca, M. Cellular Neural Network Processing of CEUS Examination. A Pilot Study, 2016 12TH IEEE INTERNATIONAL SYMPOSIUM ON ELECTRONICS AND TELECOMMUNICATIONS (ISETC'16), Pages: 309-312, 12th IEEE International Symposium on Electronics and Telecommunications (ISETC), OCT 27-28, 2016, Timisoara, ROMANIA, ISBN: 978-1-5090-3748-3, Published: 2016;
64. Branea, A.M., Gaman, M.S., Badescu, S. DEMOGRAPHIC EVOLUTION ANALYSIS OF ROMANIAN CITIES TO IDENTIFY URBAN DEVELOPMENT TYPOLOGIES, SGEM 2016, BK 4: ARTS, PERFORMING ARTS, ARCHITECTURE AND DESIGN CONFERENCE PROCEEDINGS, VOL III, Book Series: International Multidisciplinary Scientific Conferences on Social Sciences and Arts, Pages: 291-298, 3rd International Multidisciplinary Scientific Conference on Social Sciences and Arts, SGEM 2016, AUG 24-30, 2016, Albena, BULGARIA, ISSN: 2367-5659, ISBN: 978-619-7105-78-0, Published: 2016;
65. Briciu, C.V., Filip, I., Indries, I.I. Methods for cost estimation in software project management, INTERNATIONAL CONFERENCE ON APPLIED SCIENCES 2015 (ICAS2015), Book Series: IOP Conference Series-Materials Science and Engineering, Volume: 106, Article Number: 012008, International Conference on Applied Sciences (ICAS), JUN 03-05, 2015, Military Econ Acad Wuhan, Wuhan, PEOPLES R CHINA, ISSN: 1757-8981, Published: 2016;
66. Budura, G., Balint, C., Ottesteanu, M., Petrut, I. HetNet Performance Analysis from the eCIC Parameters Perspective, 2016 12TH IEEE INTERNATIONAL SYMPOSIUM ON ELECTRONICS AND TELECOMMUNICATIONS (ISETC'16), Pages: 67-70, 12th IEEE International Symposium on Electronics and Telecommunications (ISETC), OCT 27-28, 2016, Timisoara, ROMANIA, ISBN: 978-1-5090-3748-3, Published: 2016;
67. Bularka, S., Gontean, A. Brain-Computer Interface Review, 2016 12TH IEEE INTERNATIONAL SYMPOSIUM ON ELECTRONICS AND TELECOMMUNICATIONS (ISETC'16), 12th IEEE International Symposium on Electronics and Telecommunications (ISETC), OCT 27-28, 2016, Timisoara, ROMANIA, ISBN: 978-1-5090-3748-3, Published: 2016;
68. Canda, L., Heput, T., Ardelean, E. Methods for recovering precious metals from industrial waste, INTERNATIONAL CONFERENCE ON APPLIED SCIENCES 2015 (ICAS2015), Book Series: IOP Conference Series-Materials Science and Engineering, Volume: 106, Article Number: 012020, International Conference on Applied Sciences (ICAS), JUN 03-05, 2015, Military Econ Acad Wuhan, Wuhan, PEOPLES R CHINA, ISSN: 1757-8981, Published: 2016;

69. Chendes, R., Bob, C. Green Materials for Mortars, MODERN TECHNOLOGIES FOR THE 3RD MILLENNIUM, Pages: 93-98, 15th National Technical-Scientific Conference on Modern Technologies for the 3rd Millennium, NOV 27-28, 2015, Oradea, ROMANIA, ISBN: 978-88-7587-724-8, Published: 2016;
70. Chioncel, C.P., Gillich, N., Petrescu, D.I., Erdodi, G.M. Optimal Operation of an Wind Power System with Energy Storage in Electric Accumulators, PROCEEDINGS OF THE 2016 INTERNATIONAL CONFERENCE AND EXPOSITION ON ELECTRICAL AND POWER ENGINEERING (EPE 2016), Book Series: International Conference and Exposition on Electrical and Power Engineering, Pages: 858-861, 9th International Conference and Exposition on Electrical and Power Engineering (EPE), OCT 20-22, 2016, Iasi, ROMANIA, ISSN: 2471-6855, ISBN: 978-1-5090-6128-0, Published: 2016;
71. Chioncel, C.P., Spunei, E., Babescu, M. Limits of Mathematical Model used in Wind Turbine Descriptions, PROCEEDINGS OF THE 2016 INTERNATIONAL CONFERENCE AND EXPOSITION ON ELECTRICAL AND POWER ENGINEERING (EPE 2016), Book Series: International Conference and Exposition on Electrical and Power Engineering, Pages: 852-857, 9th International Conference and Exposition on Electrical and Power Engineering (EPE), OCT 20-22, 2016, Iasi, ROMANIA, ISSN: 2471-6855, ISBN: 978-1-5090-6128-0, Published: 2016;
72. Chioncel, C.P., Tirian, G.O., Gillich, N., Raduca, E. Vector control structure of an asynchronous motor at maximum torque, INTERNATIONAL CONFERENCE ON APPLIED SCIENCES 2015 (ICAS2015), Book Series: IOP Conference Series-Materials Science and Engineering, Volume: 106, Article Number: 012005, International Conference on Applied Sciences (ICAS), JUN 03-05, 2015, Military Econ Acad Wuhan, Wuhan, PEOPLES R CHINA, ISSN: 1757-8981, Published: 2016,
73. Chirila, C.B., Raes, R., Roland, A. Towards a Generic Gamification of Sorting Algorithms, 2016 12TH IEEE INTERNATIONAL SYMPOSIUM ON ELECTRONICS AND TELECOMMUNICATIONS (ISETC'16), Pages: 133-136, 12th IEEE International Symposium on Electronics and Telecommunications (ISETC), OCT 27-28, 2016, Timisoara, ROMANIA, ISBN: 978-1-5090-3748-3, Published: 2016;
74. Chirila, C.B., REUSE MODELS FOR GENERATIVE E-LEARNING CONTENT DEDICATED TO COMPUTER SCIENCE DISCIPLINES, ELEARNING VISION 2020!, VOL III, Book Series: eLearning and Software for Education, Pages: 21-27, 12th International Scientific Conference on eLearning and Software for Education (eLSE), APR 21-22, 2016, Bucharest, ROMANIA, ISSN: 2066-026X, Published: 2016;
75. Cinca, M.I., Bancea, O., Adam, M. THE EFFECT OF BUILDINGS THERMAL REHABILITATION ON ENERGY CONSUMPTION FOR CONSTRUCTION BUILT IN 1975-1985, NANO, BIO AND GREEN - TECHNOLOGIES FOR A SUSTAINABLE FUTURE CONFERENCE PROCEEDINGS, SGEM 2016, VOL II, Book Series: International Multidisciplinary Scientific GeoConference-SGEM, Pages: 747-754, 16th International Multidisciplinary Scientific Geoconference (SGEM 2016), JUN 30-JUL 06, 2016, Albena, BULGARIA, ISSN: 1314-2704, ISBN: 978-619-7105-69-8, Published: 2016;
76. Cioca, L.I., Ivascu, L., Rus, S. ANALYSIS OF CUSTOMER LOYALTY INFLUENCING FACTORS, FROM MANAGEMENT OF CRISIS TO MANAGEMENT IN A TIME OF CRISIS, Book Series: Review of Management and Economic Engineering International Management Conference, Pages: 180-185, 5th Review of Management and Economic Engineering International Management Conference, SEP 22-24, 2016, Tech Univ Cluj Napoca, Cluj Napoca, ROMANIA, ISSN: 2247-8639, Published: 2016;
77. Ciopec, A., Mirea, M. THE STUDY OF A FOUNDATION SOLUTION BY THE FLNITE ELEMENT METHOD USING CESAR-LCPC COMPUTER CODE, 16TH INTERNATIONAL MULTIDISCIPLINARY SCIENTIFIC GEOCONFERENCE, SGEM 2016: SCIENCE AND TECHNOLOGIES IN GEOLOGY, EXPLORATION AND MINING, VOL I, Book Series: International Multidisciplinary Scientific GeoConference-SGEM, Pages: 1045-1052, 16th International Multidisciplinary Scientific Geoconference (SGEM 2016), JUN 30-JUL 06, 2016, Albena, BULGARIA, ISSN: 1314-2704, ISBN: 978-619-7105-55-1, Published: 2016;
78. Ciorsac, A., Vladioiu, D.L., Fagnen, C., Louet, M., Miteva, M.A., Isvoran, A. Assessment of Some Pesticides Interactions with Human Cytochrome P450: CYP2C8, CYP2C9 and CYP2C19 by Molecular Docking Approach, 9TH INTERNATIONAL PHYSICS CONFERENCE OF THE BALKAN PHYSICAL UNION (BPU-9), Book Series: AIP Conference Proceedings, Volume: 1722, Article Number: 300001, 9th International Physics Conference of the Balkan-Physical-Union (BPU), AUG 24-27, 2015, Istanbul Univ, Beyazit Campus, Istanbul, TURKEY, ISSN: 0094-243X, ISBN: 978-0-7354-1369-6, Published: 2016;
79. Ciorsac, A.A., Dascalu, D., Spiridon, O.B., Sinitean, A., Petrovici, M., Parvulescu, L., Isvoran, A. Thematic Excursions Used as Alternative Strategies in the Teaching and Learning of the Natural Sciences at the University Level, 9TH INTERNATIONAL PHYSICS CONFERENCE OF THE BALKAN PHYSICAL UNION (BPU-9), Book Series: AIP Conference Proceedings, Volume: 1722, Article Number: 310004, 9th International Physics Conference of the Balkan-Physical-Union (BPU), AUG 24-27, 2015, Istanbul Univ, Beyazit Campus, Istanbul, TURKEY, ISSN: 0094-243X, ISBN: 978-0-7354-1369-6, Published: 2016;

80. Ciorte, I., Feier, A., Muntean, M., Man, E.T. CASE STUDY OF TURBINE FOUNDATION. METHODS TO REDUCE CONCRETE VOLUME, ECOLOGY, ECONOMICS, EDUCATION AND LEGISLATION CONFERENCE PROCEEDINGS, SGEM 2016, VOL I, Book Series: International Multidisciplinary Scientific GeoConference-SGEM, Pages: 125-132, 16th International Multidisciplinary Scientific Geoconference (SGEM 2016), JUN 30-JUL 06, 2016, Albena, BULGARIA, ISSN: 1314-2704, ISBN: 978-619-7105-65-0, Published: 2016;
81. Cirjaliu, B., Draghici, A. Ergonomic Issues in Lean Manufacturing, 13TH INTERNATIONAL SYMPOSIUM IN MANAGEMENT: MANAGEMENT DURING AND AFTER THE ECONOMIC CRISIS, Book Series: Procedia Social and Behavioral Sciences, Volume: 221, Pages: 105-110, 13th International Symposium in Management - Management During and after the Economic Crisis (SIM), OCT 09-10, 2015, Timisoara, ROMANIA, ISSN: 1877-0428, Published: 2016;
82. Cirjaliu, B., Weinschrott, H., Gaureanu, A., Boatca, E.M. A Proposal for a Risk Assessment Management in a Transport Company, 3RD GLOBAL CONFERENCE ON BUSINESS, ECONOMICS, MANAGEMENT AND TOURISM, Book Series: Procedia Economics and Finance, Volume: 39, Pages: 229-234, 3rd Global Conference on Business, Economics, Management and Tourism (BEMTUR), NOV 26-28, 2015, Rome, ITALY, ISSN: 2212-5671, Published: 2016;
83. Coccoceanu, A.L., Man, E.T., Florescu, C. Water Source Assesment for Drinking Water. Assesment/Optimization for Water Treatment Technologies, MODERN TECHNOLOGIES FOR THE 3RD MILLENNIUM, Pages: 99-104, 15th National Technical-Scientific Conference on Modern Technologies for the 3rd Millennium, NOV 27-28, 2015, Oradea, ROMANIA, ISBN: 978-88-7587-724-8, Published: 2016;
84. Costescu, C., Marc, P., Buzuriu, A., Belc, A. TECHNICAL SOLUTIONS FOR THE MODERNIZATION OF LOW TRAFFIC ROADS, ENERGY AND CLEAN TECHNOLOGIES CONFERENCE PROCEEDINGS, SGEM 2016, VOL II, Book Series: International Multidisciplinary Scientific GeoConference-SGEM, Pages: 141-148, 16th International Multidisciplinary Scientific Geoconference (SGEM 2016), JUN 30-JUL 06, 2016, Albena, BULGARIA, ISSN: 1314-2704, ISBN: 978-619-7105-64-3, Published: 2016;
85. Costescu, I.A., Nemes, N., Pelea, G.N. Monitoring the Best Available Techniques Implementation at the Ash and Slug Landfill Utvin, Timis County, Romania, WORLD MULTIDISCIPLINARY CIVIL ENGINEERING-ARCHITECTURE-URBAN PLANNING SYMPOSIUM 2016, WMCAUS 2016, Book Series: Procedia Engineering, Volume: 161, Pages: 2100-2103, World Multidisciplinary Civil Engineering-Architecture-Urban Planning Symposium (WMCAUS), JUN 13-17, 2016, Prague, CZECH REPUBLIC, ISSN: 1877-7058, Published: 2016;
86. Costescu, I.A., Pelea, G.N., Nemes, N.S. ACHIEVING A CIRCULAR ECONOMY - TRENDS AND FORECASTS OF WASTE GENERATION IN ROMANIA, ECOLOGY, ECONOMICS, EDUCATION AND LEGISLATION CONFERENCE PROCEEDINGS, SGEM 2016, VOL I, Book Series: International Multidisciplinary Scientific GeoConference-SGEM, Pages: 33-40, 16th International Multidisciplinary Scientific Geoconference (SGEM 2016), JUN 30-JUL 06, 2016, Albena, BULGARIA, ISSN: 1314-2704, ISBN: 978-619-7105-65-0, Published: 2016;
87. Costescu, I.M., Nemes, N.S., Pelea, G.N. CONSIDERATIONS REGARDING THE USE OF ULTRAFILTRATION TECHNIQUES TO IMPROVE THE QUALITY OF DRINKING WATERS, ECOLOGY, ECONOMICS, EDUCATION AND LEGISLATION CONFERENCE PROCEEDINGS, SGEM 2016, VOL I, Book Series: International Multidisciplinary Scientific GeoConference-SGEM, Pages: 203-208, 16th International Multidisciplinary Scientific Geoconference (SGEM 2016), JUN 30-JUL 06, 2016, Albena, BULGARIA, ISSN: 1314-2704, ISBN: 978-619-7105-65-0, Published: 2016;
88. Crainic, M.F., Preitl, S. Development of a Special setup for path tracking of RV-2AJ robot, 2016 IEEE 11TH INTERNATIONAL SYMPOSIUM ON APPLIED COMPUTATIONAL INTELLIGENCE AND INFORMATICS (SACI), Pages: 217-220, 11th IEEE International Symposium on Applied Computational Intelligence and Informatics (SACI), MAY 12-14, 2016, Timisoara, ROMANIA, ISBN: 978-1-5090-2380-6, Published: 2016;
89. Cristoltean, D.C., Silea, I. Didactic equipment for studying automation and applied informatics, 2016 12TH IEEE INTERNATIONAL SYMPOSIUM ON ELECTRONICS AND TELECOMMUNICATIONS (ISETC'16), Pages: 157-161, 12th IEEE International Symposium on Electronics and Telecommunications (ISETC), OCT 27-28, 2016, Timisoara, ROMANIA, ISBN: 978-1-5090-3748-3, Published: 2016;
90. Cuzic, O.S., Man, T.E., Armas, A. Introduction Into 3D Laser Scanning, MODERN TECHNOLOGIES FOR THE 3RD MILLENNIUM, Pages: 13-16, 15th National Technical-Scientific Conference on Modern Technologies for the 3rd Millennium, NOV 27-28, 2015, Oradea, ROMANIA, ISBN: 978-88-7587-724-8, Published: 2016;
91. Dan, A.M. Model-Based Estimation of the Cardiac Output in Exercise Scenario, 2016 12TH IEEE INTERNATIONAL SYMPOSIUM ON ELECTRONICS AND TELECOMMUNICATIONS (ISETC'16), Pages: 285-288, 12th IEEE International Symposium on Electronics and Telecommunications (ISETC), OCT 27-28, 2016, Timisoara, ROMANIA, ISBN: 978-1-5090-3748-3, Published: 2016;

92. Dan-Razvan, D., Andreescu, I., Pascu, G. Industry and Community in Anina, WORLD MULTIDISCIPLINARY CIVIL ENGINEERING-ARCHITECTURE-URBAN PLANNING SYMPOSIUM 2016, WMCAUS 2016, Book Series: Procedia Engineering, Volume: 161, Pages: 1977-1981, World Multidisciplinary Civil Engineering-Architecture-Urban Planning Symposium (WMCAUS), JUN 13-17, 2016, Prague, CZECH REPUBLIC, ISSN: 1877-7058, Published: 2016;
93. David, I., Gradinaru, C., Visescu, M., Vlad, I., Stefanescu, C. MODELLING OF HORIZONTAL DRAINAGE OBJECTS IN REGIONAL GROUNDWATER SIMULATION USING GRID BLOCK CORRECTIONS, 16TH INTERNATIONAL MULTIDISCIPLINARY SCIENTIFIC GEOCONFERENCE, SGEM 2016: SCIENCE AND TECHNOLOGIES IN GEOLOGY, EXPLORATION AND MINING, VOL I, Book Series: International Multidisciplinary Scientific GeoConference-SGEM, Pages: 909-919, 16th International Multidisciplinary Scientific Geoconference (SGEM 2016), JUN 30-JUL 06, 2016, Albena, BULGARIA, ISSN: 1314-2704, ISBN: 978-619-7105-55-1, Published: 2016;
94. David, I., Sumalan, I., Stefanescu, C., Visescu, M., Vlad, I., Gradinaru, C. Numerical Experiment to Analyse the Reliability of Coarse Grid based Numerical Methods for Modelling Groundwater Flow by Drainage Objects like Wells in Confined Aquifer, WORLD MULTIDISCIPLINARY CIVIL ENGINEERING-ARCHITECTURE-URBAN PLANNING SYMPOSIUM 2016, WMCAUS 2016, Book Series: Procedia Engineering, Volume: 161, Pages: 1957-1964, World Multidisciplinary Civil Engineering-Architecture-Urban Planning Symposium (WMCAUS), JUN 13-17, 2016, Prague, CZECH REPUBLIC, ISSN: 1877-7058, Published: 2016;
95. De Sabata, A., Balint, C. Structure of Signal Received by Passive Ionospheric Sounding in the HF Band at the Location of Timisoara, Romania, 2016 12TH IEEE INTERNATIONAL SYMPOSIUM ON ELECTRONICS AND TELECOMMUNICATIONS (ISETC'16), Pages: 55-58, 12th IEEE International Symposium on Electronics and Telecommunications (ISETC), OCT 27-28, 2016, Timisoara, ROMANIA, ISBN: 978-1-5090-3748-3, Published: 2016;
96. De Sabata, A., Matekovits, L., Silaghi, A., Peter, I. Anisotropic Dielectric Devised by Metamaterials-related Technique, 2016 INTERNATIONAL CONFERENCE ON COMMUNICATIONS (COMM 2016), Book Series: International Conference on Communications (ICC), Pages: 133-136, IEEE 11th International Conference on Communications (COMM), JUN 09-11, 2016, Bucharest, ROMANIA, ISBN: 978-1-4673-8197-0, Published: 2016;
97. Deaconu, I.S., Popa, G.N., Cuntan, C.D. Experimental Investigations of a Hydroelectric Power Plant, PROCEEDINGS OF THE 2016 INTERNATIONAL CONFERENCE AND EXPOSITION ON ELECTRICAL AND POWER ENGINEERING (EPE 2016), Book Series: International Conference and Exposition on Electrical and Power Engineering, Pages: 529-534, 9th International Conference and Exposition on Electrical and Power Engineering (EPE), OCT 20-22, 2016, Iasi, ROMANIA, ISSN: 2471-6855, ISBN: 978-1-5090-6128-0, Published: 2016;
98. Di Franco, B., Izvercian, M. Analysis of Consumer Behaviours in Presence of a Radical Innovation, PROCEEDINGS OF THE 4TH INTERNATIONAL CONFERENCE ON INNOVATION AND ENTREPRENEURSHIP (ICIE 2016), Pages: 307-316, 4th International Conference on Innovation and Entrepreneurship (ICIE), APR 28-29, 2016, Ryerson Univ, Ted Rogers Sch Management, Toronto, CANADA, ISBN: 978-1-910810-87-3, Published: 2016;
99. Di Franco, B., Izvercian, M., Ivascu, L. The Impact of the Automotive Sector on Sustainable Development, INNOVATION MANAGEMENT AND EDUCATION EXCELLENCE VISION 2020: FROM REGIONAL DEVELOPMENT SUSTAINABILITY TO GLOBAL ECONOMIC GROWTH, VOLS I - VI, Pages: 2643-2650, 27th International Business Information Management Association Conference, MAY 04-05, 2016, Milan, ITALY, ISBN: 978-0-9860419-6-9, Published: 2016;
100. Dinis, C.M., Popa, G.N., Iagar, A. Control of Mechanism for Pushing Trucks Using Siemens PLC, 2016 INTERNATIONAL CONFERENCE ON APPLIED AND THEORETICAL ELECTRICITY (ICATE), Book Series: International Conference on Applied and Theoretical Electricity, International Conference on Applied and Theoretical Electricity (ICATE), OCT 06-08, 2016, Craiova, ROMANIA, ISSN: 2376-4163, ISBN: 978-1-4673-8562-6, Published: 2016;
101. Dinis, C.M., Popa, G.N., Iagar, A. Research on temperature control with numerical regulators in electric resistance furnaces with indirect heating, INTERNATIONAL CONFERENCE ON APPLIED SCIENCES 2015 (ICAS2015), Book Series: IOP Conference Series-Materials Science and Engineering, Volume: 106, Article Number: 012014, International Conference on Applied Sciences (ICAS), JUN 03-05, 2015, Military Econ Acad Wuhan, Wuhan, PEOPLES R CHINA, ISSN: 1757-8981, Published: 2016;

102. Dinu, F., Marginean, I., Sigauan, A., Dubina, D. INFLUENCE OF COMPOSITE SLABS AND BEAMS ON THE PROGRESSIVE COLLAPSE RESISTANCE OF STEEL FRAME BUILDINGS, IRF2016: 5TH INTERNATIONAL CONFERENCE INTEGRITY-RELIABILITY-FAILURE, Pages: 1451-1452, 5th International Conference on Integrity-Reliability-Failure (IRF), JUL 24-28, 2016, Univ Porto, Fac Engn, Porto, PORTUGAL, ISBN: 978-989-98832-5-3, Published: 2016;
103. Dinu, F., Sigauan, A., Marginean, I., Dubina, D., Ghicioi, E. STRUCTURAL RESPONSE OF MULTI-STOREY STEEL BUILDING FRAMES TO EXTERNAL BLAST LOADING, IRF2016: 5TH INTERNATIONAL CONFERENCE INTEGRITY-RELIABILITY-FAILURE, Pages: 1423-1424, 5th International Conference on Integrity-Reliability-Failure (IRF), JUL 24-28, 2016, Univ Porto, Fac Engn, Porto, PORTUGAL, ISBN: 978-989-98832-5-3, Published: 2016;
104. Dobrean, C., Biriescu, M., Padeanu, L., Jurca, T., Marcel-Romulus, J., Padureanu, J. Centring in Magnetic Field of Synchronous Generators Rotor Using Virtual Instrumentation, 2016 INTERNATIONAL CONFERENCE ON INFORMATION AND DIGITAL TECHNOLOGIES (IDT), Pages: 64-70, International Conference on Information and Digital Technologies (IDT), JUL 05-07, 2016, Rzeszow, POLAND, ISBN: 978-1-4673-8860-3, Published: 2016;
105. Draghici, A., Baban, C.F., Ivascu, L., Gaureanu, A. A Proposed Business Model to Reinforce Universities-Industry Collaboration in Open Innovation, INNOVATION MANAGEMENT AND EDUCATION EXCELLENCE VISION 2020: FROM REGIONAL DEVELOPMENT SUSTAINABILITY TO GLOBAL ECONOMIC GROWTH, VOLS I - VI, Pages: 2600-2613, 27th International Business Information Management Association Conference, MAY 04-05, 2016, Milan, ITALY, ISBN: 978-0-9860419-6-9, Published: 2016;
106. Draghici, A., Ivascu, L. STUDENTS PERCEPTION ON HIGHER EDUCATION OPPORTUNITIES, PROCEEDINGS OF THE 13TH INTERNATIONAL CONFERENCE EFFICIENCY AND RESPONSIBILITY IN EDUCATION, Book Series: Efficiency and Responsibility in Education Pages: 80-86, 13th International Conference Efficiency and Responsibility in Education (ERIE), JUN 02-03, 2016, Prague, CZECH REPUBLIC, ISSN: 2336-744X, ISBN: 978-80-213-2646-0, Published: 2016;
107. Draghici, A., Siakas, K., Albulescu, C.T. COMPARISON BETWEEN ENTREPRENEURSHIP EDUCATION IN ROMANIA AND GREECE - THE CASE OF TWO HIGHER EDUCATION INSTITUTIONS, PROCEEDINGS OF THE 13TH INTERNATIONAL CONFERENCE EFFICIENCY AND RESPONSIBILITY IN EDUCATION, Book Series: Efficiency and Responsibility in Education Pages: 87-96, 13th International Conference Efficiency and Responsibility in Education (ERIE), JUN 02-03, 2016, Prague, CZECH REPUBLIC, ISSN: 2336-744X, ISBN: 978-80-213-2646-0, Published: 2016;
108. Duca, D.A., Lupa, L., Coheci, L., Pode, R. RECLAIMING OF ZINC ASH AS ZINCITE AND LAYERED DOUBLE HYDROXIDE, ENERGY AND CLEAN TECHNOLOGIES CONFERENCE PROCEEDINGS, SGEM 2016, VOL II, Book Series: International Multidisciplinary Scientific GeoConference-SGEM, Pages: 97-104, 16th International Multidisciplinary Scientific Geoconference (SGEM 2016), JUN 30-JUL 06, 2016, Albena, BULGARIA, ISSN: 1314-2704, ISBN: 978-619-7105-64-3, Published: 2016;
109. Duca, D.A., Vaszilcsin, N., Dan, M.L. RECYCLING OF EXPIRED MIDAZOLAM AS LEVELLING AGENT IN A WATTS ELECTROPLATING BATH, ENERGY AND CLEAN TECHNOLOGIES CONFERENCE PROCEEDINGS, SGEM 2016, VOL II, Book Series: International Multidisciplinary Scientific GeoConference-SGEM, Pages: 105-112, 16th International Multidisciplinary Scientific Geoconference (SGEM 2016), JUN 30-JUL 06, 2016, Albena, BULGARIA, ISSN: 1314-2704, ISBN: 978-619-7105-64-3, Published: 2016;
110. Dughir, C. Power wire thickness influence on the multicopters flight time, 2016 12TH IEEE INTERNATIONAL SYMPOSIUM ON ELECTRONICS AND TELECOMMUNICATIONS (ISETC'16), Pages: 239-242, 12th IEEE International Symposium on Electronics and Telecommunications (ISETC), OCT 27-28, 2016, Timisoara, ROMANIA, ISBN: 978-1-5090-3748-3, Published: 2016;
111. Dughir, C., Popovschi, A.M., Cojocariu, A.C., Topala, F.I., Negrutiu, M.L., Sinescu, C., de Sabata, A., Duma, V.F. Complete Denture Base Assessments using Holograms: Dimensional Alterations after Different Activation Methods, HIGH-END MEDICINE BASED ON LASER AND BIOTECHNOLOGIES, Book Series: Proceedings of SPIE, Volume: 9670, Article Number: 967013, 5th Congress of the World-Federation-for-Laser-Dentistry / 6th International Conference on Lasers in Medicine, MAY 07-09, 2015, Bucharest, ROMANIA, ISSN: 0277-786X, ISBN: 978-1-62841-893-4, Published: 2016;
112. Duma, V.F., Demian, D., Sinescu, C., Cernat, R., Dobre, G., Negrutiu, M.L., Topala, F.I., Hutiu, G., Bradu, A., Podoleanu, A.G. Handheld scanning probes for Optical Coherence Tomography: Developments, applications and perspectives, HIGH-END MEDICINE BASED ON LASER AND BIOTECHNOLOGIES, Book Series: Proceedings of SPIE, Volume: 9670, Article Number: 96700V, 5th Congress of the World-Federation-for-Laser-Dentistry / 6th International Conference on Lasers in Medicine, MAY 07-09, 2015, Bucharest, ROMANIA, ISSN: 0277-786X, ISBN: 978-1-62841-893-4, Published: 2016;

113. Dumitrache, C., Kherbach, O., Liviu, M., Amine, G. Supply Chain Management as a Source for Competitive Advantages of Small and Medium Sized Manufacturing Enterprises, INNOVATION MANAGEMENT AND EDUCATION EXCELLENCE VISION 2020: FROM REGIONAL DEVELOPMENT SUSTAINABILITY TO GLOBAL ECONOMIC GROWTH, VOLS I – VI, Pages: 2157-2167, 27th International Business Information Management Association Conference, MAY 04-05, 2016, Milan, ITALY, ISBN: 978-0-9860419-6-9, Published: 2016;
114. Dumitrache, C., Kherbash, O., Mocan, M.L. Improving Key Performance Indicators in Romanian Large Transport Companies, 13TH INTERNATIONAL SYMPOSIUM IN MANAGEMENT: MANAGEMENT DURING AND AFTER THE ECONOMIC CRISIS, Book Series: Procedia Social and Behavioral Sciences, Volume: 221, Pages: 211-217, 13th International Symposium in Management - Management During and after the Economic Crisis (SIM), OCT 09-10, 2015, Timisoara, ROMANIA, ISSN: 1877-0428, Published: 2016;
115. Ene, R.D., Marinca, V., Negrea, R. The flow in a viscous fluid over an unsteady stretching surface, 2015 17TH INTERNATIONAL SYMPOSIUM ON SYMBOLIC AND NUMERIC ALGORITHMS FOR SCIENTIFIC COMPUTING (SYNASC), Book Series: International Symposium on Symbolic and Numeric Algorithms for Scientific Computing, Pages: 113-116, 17th International Symposium on Symbolic and Numeric Algorithms for Scientific Computing (SYNASC), SEP 21-24, 2015, Timisoara, ROMANIA, ISSN: 2470-8801, ISBN: 978-1-5090-0461-4, Published: 2016;
116. Filip, B., Vatau, D., Frigura-Iliasa, F.M., Frigura-Iliasa, M., Balcu, F. MANUFACTURING OF HIGH ENERGY ABSORPTION LOW VOLTAGE METAL OXIDE VARISTORS, NANO, BIO AND GREEN - TECHNOLOGIES FOR A SUSTAINABLE FUTURE CONFERENCE PROCEEDINGS, SGEM 2016, VOL III, Book Series: International Multidisciplinary Scientific GeoConference-SGEM, Pages: 61-68, 16th International Multidisciplinary Scientific Geoconference (SGEM 2016), JUN 30-JUL 06, 2016, Albena, BULGARIA, ISSN: 1314-2704, ISBN: 978-619-7105-79-7, Published: 2016;
117. Floricel, A., Benzar, S., Ungureanu, V., Zagari, G. Steel column-base solutions for over-roofing of existing buildings: A numerical study, RECENT PROGRESS IN STEEL AND COMPOSITE STRUCTURES, Pages: 463-470, 13th International Conference on Metal Structures (ICMS), JUN 15-17, 2016, Zielona Gora, POLAND, ISBN: 978-1-315-62319-1; 978-1-138-02946-0, Published: 2016;
118. Gabor, A., Jivanescu, A., Zaharia, C., Hategan, S., Topala, F.I., Levai, M.C., Negrutiu, M.L., Sinescu, C., Duma, V.F., Bradu, A., Podoleanu, A.G. OCT evaluation of single ceramic crowns: Comparison between conventional and chair-side CAD/CAM technologies, HIGH-END MEDICINE BASED ON LASER AND BIOTECHNOLOGIES, Book Series: Proceedings of SPIE, Volume: 9670, Article Number: 96700Z, 5th Congress of the World-Federation-for-Laser-Dentistry / 6th International Conference on Lasers in Medicine, MAY 07-09, 2015, Bucharest, ROMANIA, ISSN: 0277-786X, ISBN: 978-1-62841-893-4, Published: 2016;
119. Gabor, E.C., David, I., Stefanescu, C. Accuracy Assessment of Very High-Resolution Multispectral Images Derived Data for River Flow Modeling, WORLD MULTIDISCIPLINARY CIVIL ENGINEERING-ARCHITECTURE-URBAN PLANNING SYMPOSIUM 2016, WMCAUS 2016, Book Series: Procedia Engineering, Volume: 161, Pages: 1949-1956, World Multidisciplinary Civil Engineering-Architecture-Urban Planning Symposium (WMCAUS), JUN 13-17, 2016, Prague, CZECH REPUBLIC, ISSN: 1877-7058, Published: 2016;
120. Gal, A., Filip, I., Dragan, F. Interoperability framework for communication between processes running on different mobile operating systems, INTERNATIONAL CONFERENCE ON APPLIED SCIENCES 2015 (ICAS2015), Book Series: IOP Conference Series-Materials Science and Engineering, Volume: 106, Article Number: 012007, International Conference on Applied Sciences (ICAS), JUN 03-05, 2015, Military Econ Acad Wuhan, Wuhan, PEOPLES R CHINA, ISSN: 1757-8981, Published: 2016;
121. Gal, N., Andrei, D., Poenaru, D.V., Stoicu-Tivadar, V., Gal-Nadasan, E. A Virtual Patient Representation in the Medical Rehabilitation Domain, EXPLORING COMPLEXITY IN HEALTH: AN INTERDISCIPLINARY SYSTEMS APPROACH, Book Series: Studies in Health Technology and Informatics, Volume: 228, Pages: 147-151, Medical Informatics Europe (MIE) Conference at Conference on Health - Exploring Complexity (HEC) - An Interdisciplinary Systems Approach, AUG 28-SEP 02, 2016, Munich, GERMANY, ISSN: 0926-9630, ISBN: 978-1-61499-678-1; 978-1-61499-677-4, Published: 2016;
122. Gaman, M.S., Badescu, S., Branea, A.M., CRITICAL ANALYSIS OF TRANSPORT INFRASTRUCTURE DEVELOPMENT STRATEGIES, CASE STUDY TIMISOARA ROMANIA, SGEM 2016, BK 4: ARTS, PERFORMING ARTS, ARCHITECTURE AND DESIGN CONFERENCE PROCEEDINGS, VOL III, Book Series: International Multidisciplinary Scientific Conferences on Social Sciences and Arts, Pages: 283-290, AUG 24-30, 2016, Albena, BULGARIA, ISSN: 2367-5659, ISBN: 978-619-7105-78-0, Published: 2016;

123. Ganea, G., Marinescu, R. Modeling Design Flaw Evolution Using Complex Systems, 2015 17TH INTERNATIONAL SYMPOSIUM ON SYMBOLIC AND NUMERIC ALGORITHMS FOR SCIENTIFIC COMPUTING (SYNASC), Book Series: International Symposium on Symbolic and Numeric Algorithms for Scientific Computing, Pages: 433-436, 17th International Symposium on Symbolic and Numeric Algorithms for Scientific Computing (SYNASC), SEP 21-24, 2015, Timisoara, ROMANIA, ISSN: 2470-8801, ISBN: 978-1-5090-0461-4, Published: 2016;
124. Gasparesc, G. PID Control of a DC Motor Using Labview Interface for Embedded Platforms, 2016 12TH IEEE INTERNATIONAL SYMPOSIUM ON ELECTRONICS AND TELECOMMUNICATIONS (ISETC'16), Pages: 145-148, 12th IEEE International Symposium on Electronics and Telecommunications (ISETC), OCT 27-28, 2016, Timisoara, ROMANIA, ISBN: 978-1-5090-3748-3, Published: 2016;
125. Gaureanu, A., Ivascu, L., Weinschrott, H., Draghici, A. Knowledge Management and Ergonomics Integration for Occupational Risks Management, VISION 2020: INNOVATION MANAGEMENT, DEVELOPMENT SUSTAINABILITY, AND COMPETITIVE ECONOMIC GROWTH, 2016, VOLS I – VII, Pages: 4222-4231, 28th International Business-Information-Management-Association Conference, NOV 09-10, 2016, Seville, SPAIN, ISBN: 978-0-9860419-8-3, Published: 2016;
126. Gaureanu, A., Weinschrott, H., Mateescu, A., Draghici, A. Workplace Wellbeing – An Ergonomics Approach Focus on Workplace Usability Evaluation, VISION 2020: INNOVATION MANAGEMENT, DEVELOPMENT SUSTAINABILITY, AND COMPETITIVE ECONOMIC GROWTH, 2016, VOLS I – VII, Pages: 4232-4240, 28th International Business-Information-Management-Association Conference, NOV 09-10, 2016, Seville, SPAIN, ISBN: 978-0-9860419-8-3, Published: 2016;
127. Georgescu, M., Ungureanu, V. Cantilever Steel Industrial Building Located on a Rocky Hill, WORLD MULTIDISCIPLINARY CIVIL ENGINEERING-ARCHITECTURE-URBAN PLANNING SYMPOSIUM 2016, WMCAUS 2016, Book Series: Procedia Engineering, Volume: 161, Pages: 516-522, World Multidisciplinary Civil Engineering-Architecture-Urban Planning Symposium (WMCAUS), JUN 13-17, 2016, Prague, CZECH REPUBLIC, ISSN: 1877-7058, Published: 2016;
128. Ghemis, M.T., Golea, L.A., Tudorica, R.M., Bob, C. SOME ASPECTS REGARDING THE IMPORTANCE OF A SUSTAINABILITY ANALYSIS IN DESIGNING A NEW BUILDING, ENERGY AND CLEAN TECHNOLOGIES CONFERENCE PROCEEDINGS, SGEM 2016, VOL I, Book Series: International Multidisciplinary Scientific GeoConference-SGEM, Pages: 653-660, 16th International Multidisciplinary Scientific Geoconference (SGEM 2016), JUN 30-JUL 06, 2016, Albena, BULGARIA, ISSN: 1314-2704, ISBN: 978-619-7105-63-6, Published: 2016;
129. Gheorghiu, C.A., Heput, T., Popa, E. The Optimisation of the Viscosity of Lubricating Slags used in the Continuous Casting of Steel, PROCEEDINGS OF THE INTERNATIONAL CONFERENCE ON NUMERICAL ANALYSIS AND APPLIED MATHEMATICS 2015 (ICNAAM-2015), Book Series: AIP Conference Proceedings, Volume: 1738, Article Number: 080004, International Conference on Numerical Analysis and Applied Mathematics (ICNAAM), SEP 23-29, 2015, Rhodes, GREECE, ISSN: 0094-243X, ISBN: 978-0-7354-1392-4, Published: 2016;
130. Ghera, C., Mitelea, I., Bordeasu, I., Craciunescu, C. CAVITATION EROSION BEHAVIOR OF LASER NITRIDED 34CrNiMo6 ALLOYED STEEL, METAL 2016: 25TH ANNIVERSARY INTERNATIONAL CONFERENCE ON METALLURGY AND MATERIALS, Pages: 706-711, 25th Anniversary International Conference on Metallurgy and Materials (METAL), MAY 25-27, 2016, Brno, CZECH REPUBLIC, ISBN: 978-80-87294-67-3, Published: 2016;
131. Ghiormez, L., Panoiu, M., Panoiu, C., Rob, R. Electric Arc Model in PSCAD – EMTDC as embedded component and the dependency of the desired Active Power, 2016 IEEE 14TH INTERNATIONAL CONFERENCE ON INDUSTRIAL INFORMATICS (INDIN), Book Series: IEEE International Conference on Industrial Informatics INDIN, Pages: 351-356, 14th IEEE International Conference on Industrial Informatics (INDIN), JUL 19-21, 2016, Poitiers, FRANCE, ISSN: 1935-4576, ISBN: 978-1-5090-2870-2, Published: 2016;
132. Ghiormez, L., Prostean, O., Panoiu, M., Panoiu, C. Fuzzy Logic and PD Control Strategies of a Three-Phase Electric Arc Furnace, COMPUTATIONAL COLLECTIVE INTELLIGENCE, ICCCI 2016, PT I, Book Series: Lecture Notes in Artificial Intelligence, Volume: 9875, Pages: 509-519, 8th International Conference on Computational Collective Intelligence (ICCCI), SEP 28-30, 2016, Halkidiki, GREECE, ISSN: 0302-9743, ISBN: 978-3-319-45242-5; 978-3-319-45243-2, Published: 2016;
133. Ghitescu, M.A., Constantin, A.T., Girbaci, M.I. STUDYING THE INFLUENCE OF RIVER WORKS USING 1D HYDRODYNAMIC MODELLING TOOL, WATER, RESOURCES, FOREST, MARINE AND OCEAN ECOSYSTEMS CONFERENCE PROCEEDINGS, VOL I, Book Series: International Multidisciplinary Scientific GeoConference-SGEM, Pages: 691-695, 16th International Multidisciplinary Scientific Geoconference (SGEM 2016), JUN 30-JUL 06, 2016, Albena, BULGARIA, ISSN: 1314-2704, ISBN: 978-619-7105-61-2, Published: 2016;

134. Ghitescu, M.A., Constantin, A.T., Lazar, G. Busan, A.I.P., Nicoara, S.V. 1D/2D NUMERICAL MODELING OF A HIGH-WATER FLOW, WATER RESOURCES, FOREST, MARINE AND OCEAN ECOSYSTEMS CONFERENCE PROCEEDINGS, SGEM 2016, VOL III, Book Series: International Multidisciplinary Scientific GeoConference-SGEM, Pages: 3-10, 16th International Multidisciplinary Scientific Geoconference, SGEM2016, NOV 02-05, 2016, Vienna, AUSTRIA, ISSN: 1314-2704, ISBN: 978-619-7105-81-0, Published: 2016;
135. Ghitescu, M.A., Girbaci, A.I., Girbaci, C.A., HYDRODYNAMIC MODELING OF A WATER COURSE FROM BANAT WATERSHED USING MIKE11, WATER, RESOURCES, FOREST, MARINE AND OCEAN ECOSYSTEMS CONFERENCE PROCEEDINGS, VOL I, Book Series: International Multidisciplinary Scientific GeoConference-SGEM, Pages: 423-428, 16th International Multidisciplinary Scientific Geoconference (SGEM 2016), JUN 30-JUL 06, 2016, Albena, BULGARIA, ISSN: 1314-2704, ISBN: 978-619-7105-61-2, Published: 2016;
136. Giovannella, C., Andone, D., Dascalu, M., Popescu, E., Rehm, M., Mealha, O. Evaluating the Resilience of the Bottom-up Method used to Detect and Benchmark the Smartness of University Campuses, IEEE SECOND INTERNATIONAL SMART CITIES CONFERENCE (ISC2 2016), Pages: 341-345, 2nd IEEE International Smart Cities Conference (ISC2), SEP 12-15, 2016, Trento, ITALY, ISBN: 978-1-5090-1845-1, Published: 2016;
137. Gogan, L.M., Artene, A., Sarca, I., Draghici, A. The Impact of Intellectual Capital on Organizational Performance, 13TH INTERNATIONAL SYMPOSIUM IN MANAGEMENT: MANAGEMENT DURING AND AFTER THE ECONOMIC CRISIS, Book Series: Procedia Social and Behavioral Sciences, Volume: 221, Pages: 194-202, 13th International Symposium in Management - Management During and after the Economic Crisis (SIM), OCT 09-10, 2015, Timisoara, ROMANIA, ISSN: 1877-0428, Published: 2016;
138. Gradinaru, C., Herban, I.S., Gabor, C. Development of Urban Green Space Monitoring Technique with Remote Sensing and its Application, PROCEEDINGS OF THE INTERNATIONAL CONFERENCE ON NUMERICAL ANALYSIS AND APPLIED MATHEMATICS 2015 (ICNAAM-2015), Book Series: AIP Conference Proceedings, Volume: 1738, Article Number: 350004, International Conference on Numerical Analysis and Applied Mathematics (ICNAAM), SEP 23-29, 2015, Rhodes, GREECE, ISSN: 0094-243X, ISBN: 978-0-7354-1392-4, Published: 2016;
139. Grecea, C., Herban, S., Vilceanu, C.B. WebGIS Solution for Urban Planning Strategies, WORLD MULTIDISCIPLINARY CIVIL ENGINEERING-ARCHITECTURE-URBAN PLANNING SYMPOSIUM 2016, WMCAUS 2016, Book Series: Procedia Engineering, Volume: 161, Pages: 1625-1630, World Multidisciplinary Civil Engineering-Architecture-Urban Planning Symposium (WMCAUS), JUN 13-17, 2016, Prague, CZECH REPUBLIC, ISSN: 1877-7058, Published: 2016;
140. Greculescu, A., Todorescu, L. Language Experience and Engineering Students' Professional Mobility, NEW APPROACHES IN SOCIAL AND HUMANISTIC SCIENCES, Pages: 255-258, Central and Eastern European Lumen Conference on New Approaches in Social and Humanistic Sciences, SEP 11-13, 2015, Chisinau, MOLDOVA, ISBN: 978-88-7587-728-6, Published: 2016;
141. Greculescu, A., Todorescu, L. Language Teaching Resources and Quality Assurance in Higher Technical Education, NEW APPROACHES IN SOCIAL AND HUMANISTIC SCIENCES, Pages: 249-253, Central and Eastern European Lumen Conference on New Approaches in Social and Humanistic Sciences, SEP 11-13, 2015, Chisinau, MOLDOVA, ISBN: 978-88-7587-728-6, Published: 2016;
142. Gridan, M.R., Bala, A.C., Brebu, F.M. Tridimensional Modeling using Close Range Photogrammetry, MODERN TECHNOLOGIES FOR THE 3RD MILLENNIUM, Pages: 17-22, 15th National Technical-Scientific Conference on Modern Technologies for the 3rd Millennium, NOV 27-28, 2015, Oradea, ROMANIA, ISBN: 978-88-7587-724-8, Published: 2016;
143. Groza, B., Gurban, H.E., Murvay, P.S. Designing security for in-vehicle networks: a Body Control Module (BCM) centered viewpoint, 2016 46TH ANNUAL IEEE/IFIP INTERNATIONAL CONFERENCE ON DEPENDABLE SYSTEMS AND NETWORKS WORKSHOPS (DSN-W), Pages: 176-183, 46th Annual IEEE/IFIP International Conference on Dependable Systems and Networks Workshops (DSN-W), JUN 28-JUL 01, 2016, Toulouse, FRANCE, ISBN: 978-1-4673-8891-7, Published: 2016;
144. Groza, B., Murvay, P.S., Andreica, T. Evaluating SRAM as Source for Fingerprints and Randomness on Automotive Grade Controllers, SECRIPT: PROCEEDINGS OF THE 13TH INTERNATIONAL JOINT CONFERENCE ON E-BUSINESS AND TELECOMMUNICATIONS - VOL. 4, Pages: 109-120, 13th International Joint Conference on e-Business and Telecommunications, JUL 26-28, 2016, Lisbon, PORTUGAL, ISBN: 978-989-758-196-0, Published: 2016;
145. Halbac-Cotoara-Zamfir, R. Applied Hydrotechnics Multidisciplinary Research and Future Challenges, WORLD MULTIDISCIPLINARY CIVIL ENGINEERING-ARCHITECTURE-URBAN PLANNING SYMPOSIUM 2016, WMCAUS 2016, Book Series: Procedia Engineering, Volume: 161, Pages: 2019-2022, World Multidisciplinary Civil Engineering-Architecture-Urban Planning Symposium (WMCAUS), JUN 13-17, 2016, Prague, CZECH REPUBLIC, ISSN: 1877-7058, Published: 2016;

146. Halbac-Cotoara-Zamfir, R. CLIMATE CHANGES IN THE LAST 20 YEARS. STUDY CASE: TIMIS COUNTY, ROMANIA, ENERGY AND CLEAN TECHNOLOGIES CONFERENCE PROCEEDINGS, SGEM 2016, VOL II, Book Series: International Multidisciplinary Scientific GeoConference-SGEM, Pages: 267-274, 16th International Multidisciplinary Scientific Geoconference (SGEM 2016), JUN 30-JUL 06, 2016, Albena, BULGARIA, ISSN: 1314-2704, ISBN: 978-619-7105-64-3, Published: 2016;
147. Halbac-Cotoara-Zamfir, R., Herban, S., Stolte, J., Skaalsveen, K. MANAGING EXTREME WEATHER EVENTS IN SMALL-SCALE CATCHMENTS: NORWEGIAN VS. ROMANIAN APPROACH, WATER RESOURCES, FOREST, MARINE AND OCEAN ECOSYSTEMS CONFERENCE PROCEEDINGS, SGEM 2016, VOL III, Book Series: International Multidisciplinary Scientific GeoConference-SGEM, Pages: 181-188, 16th International Multidisciplinary Scientific Geoconference, SGEM2016, NOV 02-05, 2016, Vienna, AUSTRIA, ISSN: 1314-2704, ISBN: 978-619-7105-81-0, Published: 2016;
148. Halbac-Cotoara-Zamfir, R., Vladi, B. INNOVATION MANAGEMENT IN AGRICULTURAL ENGINEERING, WATER RESOURCES, FOREST, MARINE AND OCEAN ECOSYSTEMS CONFERENCE PROCEEDINGS, SGEM 2016, VOL II, Book Series: International Multidisciplinary Scientific GeoConference-SGEM, Pages: 193-198, 16th International Multidisciplinary Scientific Geoconference (SGEM 2016), JUN 30-JUL 06, 2016, Albena, BULGARIA, ISSN: 1314-2704, ISBN: 978-619-7105-62-9, Published: 2016;
149. Hedrea, E.L., Radac, M.B., Precup, R.E. Virtual Reference Feedback Tuning for Position Control of a Twin Rotor Aerodynamic System, 2016 IEEE 11TH INTERNATIONAL SYMPOSIUM ON APPLIED COMPUTATIONAL INTELLIGENCE AND INFORMATICS (SACI), Pages: 57-62, 11th IEEE International Symposium on Applied Computational Intelligence and Informatics (SACI), MAY 12-14, 2016, Timisoara, ROMANIA, ISBN: 978-1-5090-2380-6, Published: 2016;
150. Hernea, S., Feier, A., Filimon, M.N., Ciortea, I., Buzdugan, M. ROBUSTNESS A CONCEPT IN CASE OF HISTORIC BRIDGES. ECONOMICAL STUDIES REGARDING REHABILITATION AND ROBUSTNESS, ECOLOGY, ECONOMICS, EDUCATION AND LEGISLATION CONFERENCE PROCEEDINGS, SGEM 2016, VOL III, Book Series: International Multidisciplinary Scientific GeoConference-SGEM, Pages: 509-514, 16th International Multidisciplinary Scientific Geoconference (SGEM 2016), JUN 30-JUL 06, 2016, Albena, BULGARIA, ISSN: 1314-2704, ISBN: 978-619-7105-67-4, Published: 2016;
151. Hulea, D., Cornea, O., Muntean, N. Nonlinear Droop Charging Control of a Supercapacitor with a Bi-Directional Hybrid DC-DC Converter, 2016 IEEE 16TH INTERNATIONAL CONFERENCE ON ENVIRONMENT AND ELECTRICAL ENGINEERING (EEEIC), IEEE 16th International Conference on Environment and Electrical Engineering (EEEIC), JUN 07-10, 2016, Florence, ITALY, ISBN: 978-1-5090-2320-2, Published: 2016;
152. Iacobici-Luca, N., Frigura-Iliasa, F.M., Vatau, D., Andea, P. Power Quality Assessment System for a 220 kV/110 kV High Voltage Power Station, 10TH INTERNATIONAL CONFERENCE 2016 ELECTRIC POWER QUALITY AND SUPPLY RELIABILITY CONFERENCE (PQ), Pages: 267-272, 10th International Conference on Electric Power Quality and Supply Reliability (PQ), AUG 29-31, 2016, Tallinn, ESTONIA, ISBN: 978-1-5090-1562-7, Published: 2016;
153. Iagar, A., Popa, G.N., Dinis, C.M. Study of thermal regimes of an electric resistance furnace using AT-503 controller, INTERNATIONAL CONFERENCE ON APPLIED SCIENCES 2015 (ICAS2015) Book Series: IOP Conference Series-Materials Science and Engineering, Volume: 106, Article Number: 012006, International Conference on Applied Sciences (ICAS), JUN 03-05, 2015, Military Econ Acad Wuhan, Wuhan, PEOPLES R CHINA, ISSN: 1757-8981, Published: 2016;
154. Idiceanu-Mathe, D., Carjan, R. Architecture for the New Man in the 1950's in Romania. First Glimpse of Communism Build Environment, WORLD MULTIDISCIPLINARY CIVIL ENGINEERING-ARCHITECTURE-URBAN PLANNING SYMPOSIUM 2016, WMCAUS 2016, Book Series: Procedia Engineering, Volume: 161, Pages: 1520-1526, World Multidisciplinary Civil Engineering-Architecture-Urban Planning Symposium (WMCAUS), JUN 13-17, 2016, Prague, CZECH REPUBLIC, ISSN: 1877-7058, Published: 2016;
155. Ilie, S., Toader, D., Barvinschi, F. Modern Education on Renewable Energies by Using Numerical Finite Element Method of a Solar Powered Stirling Engine with Heat Transfer Simulations, 2016 12TH IEEE INTERNATIONAL SYMPOSIUM ON ELECTRONICS AND TELECOMMUNICATIONS (ISETC'16), Pages: 137-140, 12th IEEE International Symposium on Electronics and Telecommunications (ISETC), OCT 27-28, 2016, Timisoara, ROMANIA, ISBN: 978-1-5090-3748-3, Published: 2016;
156. Ioan, V., Beilicci, R., Beilicci, E., Visescu, M. Approach Channel Modelling with Advanced Hydroinformatic Tool, Case Study: Small Hydro Power Plant Huta Certeze, Romania, WORLD MULTIDISCIPLINARY CIVIL ENGINEERING-ARCHITECTURE-URBAN PLANNING SYMPOSIUM 2016, WMCAUS 2016, Book Series: Procedia Engineering, Volume: 161, Pages: 898-903, World Multidisciplinary Civil Engineering-Architecture-Urban Planning Symposium (WMCAUS), JUN 13-17, 2016, Prague, CZECH REPUBLIC, ISSN: 1877-7058, Published: 2016;

157. Ionescu, D., Kovaci, M. Performances of the racetrack memories of high density based on intermetallic compounds with high anisotropy in L1(0) phase, 2016 12TH IEEE INTERNATIONAL SYMPOSIUM ON ELECTRONICS AND TELECOMMUNICATIONS (ISETC'16), Pages: 117-121, 12th IEEE International Symposium on Electronics and Telecommunications (ISETC), OCT 27-28, 2016, Timisoara, ROMANIA, ISBN: 978-1-5090-3748-3, Published: 2016;
158. Ionescu, D., Kovaci, M. Study of the spin valves based on materials with high magnetocrystalline anisotropy used in spintronics, 2016 12TH IEEE INTERNATIONAL SYMPOSIUM ON ELECTRONICS AND TELECOMMUNICATIONS (ISETC'16), Pages: 122-126, 12th IEEE International Symposium on Electronics and Telecommunications (ISETC), OCT 27-28, 2016, Timisoara, ROMANIA, ISBN: 978-1-5090-3748-3, Published: 2016;
159. Iovan, A., Robu, R. Handling of the demilitarized zone using service providers in SAP, INTERNATIONAL CONFERENCE ON APPLIED SCIENCES 2015 (ICAS2015), Book Series: IOP Conference Series-Materials Science and Engineering, Volume: 106 Article Number: 012003, International Conference on Applied Sciences (ICAS), JUN 03-05, 2015, Military Econ Acad Wuhan, Wuhan, PEOPLES R CHINA, ISSN: 1757-8981, Published: 2016;
160. Isar, A., Nafornta, C. Sentinel 1 Stripmap GRDH Image Despeckling Using Two Stages Algorithms, 2016 12TH IEEE INTERNATIONAL SYMPOSIUM ON ELECTRONICS AND TELECOMMUNICATIONS (ISETC'16), Pages: 343-348, 12th IEEE International Symposium on Electronics and Telecommunications (ISETC), OCT 27-28, 2016, Timisoara, ROMANIA, ISBN: 978-1-5090-3748-3, Published: 2016;
161. Isar, D., Gajitzki, P. Pink Noise Generation Using Wavelets, 2016 12TH IEEE INTERNATIONAL SYMPOSIUM ON ELECTRONICS AND TELECOMMUNICATIONS (ISETC'16), Pages: 261-264, 12th IEEE International Symposium on Electronics and Telecommunications (ISETC), OCT 27-28, 2016, Timisoara, ROMANIA, ISBN: 978-1-5090-3748-3, Published: 2016;
162. Isfanuti, A.S., Tutelea, L.N., Staudt, T., Maria, D.F., Laureano, A.R., Giancesini, M.A., Boldea, I. Small Single-Phase Two Pole Ferrite-PM-Stator Double-Saliency Motor: Optimal Design and Experimental Characterization, 2016 XXII INTERNATIONAL CONFERENCE ON ELECTRICAL MACHINES (ICEM), Pages: 2492-2497, 22nd International Conference on Electrical Machines (ICEM), SEP 04-07, 2016, Lausanne, SWITZERLAND, ISBN: 978-1-5090-2538-1, Published: 2016;
163. Ivanova, M., Holotescu, C., Grosseck, G., Iapa, C. RELATIONS BETWEEN LEARNING ANALYTICS AND DATA PRIVACY IN MOOCs, E-LEARNING VISION 2020!, VOL III, Book Series: eLearning and Software for Education, Pages: 13-20, 12th International Scientific Conference on eLearning and Software for Education (eLSE), APR 21-22, 2016, Bucharest, ROMANIA, ISSN: 2066-026X, Published: 2016;
164. Ivascu, L., Cioca, L.I. Evaluation of Sustainable Development Requirements for Companies in the Context of Global Progress, VISION 2020: INNOVATION MANAGEMENT, DEVELOPMENT SUSTAINABILITY, AND COMPETITIVE ECONOMIC GROWTH, 2016, VOLS I – VII, Pages: 1688-1693, 28th International Business-Information-Management-Association Conference, NOV 09-10, 2016, Seville, SPAIN, ISBN: 978-0-9860419-8-3, Published: 2016;
165. Ivascu, L., Cioca, L.I., Rus, S. Sustainable Development Influence on the Competitive Advantage of Companies, INNOVATION MANAGEMENT AND EDUCATION EXCELLENCE VISION 2020: FROM REGIONAL DEVELOPMENT SUSTAINABILITY TO GLOBAL ECONOMIC GROWTH, VOLS I – VI, Pages: 510-517, 27th International Business Information Management Association Conference, MAY 04-05, 2016, Milan, ITALY, ISBN: 978-0-9860419-6-9, Published: 2016;
166. Ivascu, L., Cirjaliu, B., Draghici, A. Business model for the university-industry collaboration in open innovation, 3RD GLOBAL CONFERENCE ON BUSINESS, ECONOMICS, MANAGEMENT AND TOURISM, Book Series: Procedia Economics and Finance, Volume: 39, Pages: 674-678, 3rd Global Conference on Business, Economics, Management and Tourism (BEMTUR), NOV 26-28, 2015, Rome, ITALY, ISSN: 2212-5671, Published: 2016;
167. Izvercian, M., Miclea, S., Potra, S. Marketing Practices in SMEs. Case Study: Romania vs. Malta, 13TH INTERNATIONAL SYMPOSIUM IN MANAGEMENT: MANAGEMENT DURING AND AFTER THE ECONOMIC CRISIS, Book Series: Procedia Social and Behavioral Sciences, Volume: 221, Pages: 135-141, 13th International Symposium in Management - Management During and after the Economic Crisis (SIM), OCT 09-10, 2015, Timisoara, ROMANIA, ISSN: 1877-0428, Published: 2016;
168. Izvercian, M., Potra, S., Ivascu, L. Job Satisfaction Variables: A Grounded Theory Approach, 13TH INTERNATIONAL SYMPOSIUM IN MANAGEMENT: MANAGEMENT DURING AND AFTER THE ECONOMIC CRISIS, Book Series: Procedia Social and Behavioral Sciences, Volume: 221, Pages: 86-94, 13th International Symposium in Management - Management During and after the Economic Crisis (SIM), OCT 09-10, 2015, Timisoara, ROMANIA, ISSN: 1877-0428, Published: 2016;

169. Jigoria-Oprea, D., Vuc, G., Litcanu, M. Optimal management of a virtual power plant, 2016 IEEE 16TH INTERNATIONAL CONFERENCE ON ENVIRONMENT AND ELECTRICAL ENGINEERING (EEEIC), IEEE 16th International Conference on Environment and Electrical Engineering (EEEIC), JUN 07-10, 2016, Florence, ITALY, ISBN: 978-1-5090-2320-2, Published: 2016;
170. Josan, A., Bretotean, C.P., Putan, V. The critical analysis of austenitic manganese steel T130Mn135 used for castings in the mining industry, INTERNATIONAL CONFERENCE ON APPLIED SCIENCES 2015 (ICAS2015), Book Series: IOP Conference Series-Materials Science and Engineering, Volume: 106, Article Number: 012021, International Conference on Applied Sciences (ICAS), JUN 03-05, 2015, Military Econ Acad Wuhan, Wuhan, PEOPLES R CHINA, ISSN: 1757-8981, Published: 2016;
171. Jurcau, D.A., Stoicu-Tivadar, V. Evaluating Open-Source Full-Text Search Engines for Matching ICD-10 Codes, UNIFYING THE APPLICATIONS AND FOUNDATIONS OF BIOMEDICAL AND HEALTH INFORMATICS, Book Series: Studies in Health Technology and Informatics, Volume: 226, Pages: 127-130, 14th Annual International Conference on Informatics, Management, and Technology in Healthcare (ICIMTH), JUL 01-03, 2016, Athens, GREECE, ISSN: 0926-9630, ISBN: 978-1-61499-664-4; 978-1-61499-663-7, Published: 2016;
172. Katona, S.E., Karancsi, O., Bordeasu, I., Mitelea, I., Craciunescu, M.C. PRIMARY AND SECONDARY AGING EFFECT ON THE CAVITATION EROSION BEHAVIOR OF 17-4 PH STAINLESS STEELS, METAL 2016: 25TH ANNIVERSARY INTERNATIONAL CONFERENCE ON METALLURGY AND MATERIALS, Pages: 543-548, 25th Anniversary International Conference on Metallurgy and Materials (METAL), MAY 25-27, 2016, Brno, CZECH REPUBLIC, ISBN: 978-80-87294-67-3, Published: 2016;
173. Kherbach, O., Mocan, M.L. The importance of logistics and supply chain management in the enhancement of Romanian SMEs, 13TH INTERNATIONAL SYMPOSIUM IN MANAGEMENT: MANAGEMENT DURING AND AFTER THE ECONOMIC CRISIS, Book Series: Procedia Social and Behavioral Sciences, Volume: 221, Pages: 405-413, 13th International Symposium in Management - Management During and after the Economic Crisis (SIM), OCT 09-10, 2015, Timisoara, ROMANIA, ISSN: 1877-0428, Published: 2016;
174. Kuczapski, A.M., Andreescu, G.D. Real-time Interfacing for Fault Detection and Auralization with MED-EL Cochlear Implant Processors, 2016 IEEE 11TH INTERNATIONAL SYMPOSIUM ON APPLIED COMPUTATIONAL INTELLIGENCE AND INFORMATICS (SACI), Pages: 191-195, 11th IEEE International Symposium on Applied Computational Intelligence and Informatics (SACI), MAY 12-14, 2016, Timisoara, ROMANIA, ISBN: 978-1-5090-2380-6, Published: 2016;
175. Lazarescu, E., Frigura-Iliasa, F.M., Andea, P., Frigura-Iliasa, M. Speed Control for a Permanent Magnet Synchronous Motor based on Fuzzy Logic With Reduced Perturbations on the Supply Network, 10TH INTERNATIONAL CONFERENCE 2016 ELECTRIC POWER QUALITY AND SUPPLY RELIABILITY CONFERENCE (PQ), Pages: 207-211, 10th International Conference on Electric Power Quality and Supply Reliability (PQ), AUG 29-31, 2016, Tallinn, ESTONIA, ISBN: 978-1-5090-1562-7, Published: 2016;
176. Leontiu, F.C., Bob, C. SUSTAINABILITY OF THE HYGROTHERMAL REHABILITATION OF A HISTORICAL BUILDING BY USING AN OUTER HEAT INSULATION WITH AIRED LAYER AND THE REPLICATION OF THE BORDERS, NANO, BIO AND GREEN - TECHNOLOGIES FOR A SUSTAINABLE FUTURE CONFERENCE PROCEEDINGS, SGEM 2016, VOL II Book Series: International Multidisciplinary Scientific GeoConference-SGEM, Pages: 525-531, 16th International Multidisciplinary Scientific Geoconference (SGEM 2016), JUN 30-JUL 06, 2016, Albena, BULGARIA, ISSN: 1314-2704, ISBN: 978-619-7105-69-8, Published: 2016;
177. Leontiu, F.C., Bob, C. GRAPHICAL METHODS FOR DETERMINING THE SUSTAINABILITY OF INVESTMENTS IN THE REHABILITATION OF EXISTING BUILDINGS, NANO, BIO AND GREEN - TECHNOLOGIES FOR A SUSTAINABLE FUTURE CONFERENCE PROCEEDINGS, SGEM 2016, VOL II, Book Series: International Multidisciplinary Scientific GeoConference-SGEM, Pages: 571-577, 16th International Multidisciplinary Scientific Geoconference (SGEM 2016), JUN 30-JUL 06, 2016, Albena, BULGARIA, ISSN: 1314-2704, ISBN: 978-619-7105-69-8, Published: 2016;
178. Leucuta, G., Halbac-Cotoara-Zamfir, R. Applied Hydrotechnical Measures in Sustainable Land Management, Case Study: Timis County, Romania, WORLD MULTIDISCIPLINARY CIVIL ENGINEERING-ARCHITECTURE-URBAN PLANNING SYMPOSIUM 2016, WMCAUS 2016, Book Series: Procedia Engineering, Volume: 161, Pages: 1833-1837, World Multidisciplinary Civil Engineering-Architecture-Urban Planning Symposium (WMCAUS), JUN 13-17, 2016, Prague, CZECH REPUBLIC, ISSN: 1877-7058, Published: 2016;
179. Leucuta, G., Halbac-Cotoara-Zamfir, R. IMPLEMENTING WOCAT METHODOLOGY IN ROMANIA. A CASE STUDY, WATER RESOURCES, FOREST, MARINE AND OCEAN ECOSYSTEMS CONFERENCE PROCEEDINGS, SGEM 2016, VOL II, Book Series: International Multidisciplinary Scientific GeoConference-SGEM, Pages: 149-156, 16th International Multidisciplinary Scientific Geoconference (SGEM 2016), JUN 30-JUL 06, 2016, Albena, BULGARIA, ISSN: 1314-2704, ISBN: 978-619-7105-62-9, Published: 2016;

180. Leucuta, G., Halbac-Cotoara-Zamfir, R. WATER CHALLENGES IN ROMANIA USING THE EUROPEAN PERSPECTIVE, WATER, RESOURCES, FOREST, MARINE AND OCEAN ECOSYSTEMS CONFERENCE PROCEEDINGS, VOL I Book Series: International Multidisciplinary Scientific GeoConference-SGEM, Pages: 829-834, 16th International Multidisciplinary Scientific Geoconference (SGEM 2016), JUN 30-JUL 06, 2016, Albena, BULGARIA, ISSN: 1314-2704, ISBN: 978-619-7105-61-2, Published: 2016;
181. Lixandru, C.G. Supplier Quality Management for Component Introduction in the Automotive Industry, 13TH INTERNATIONAL SYMPOSIUM IN MANAGEMENT: MANAGEMENT DURING AND AFTER THE ECONOMIC CRISIS, Book Series: Procedia Social and Behavioral Sciences, Volume: 221, Pages: 423-432, 13th International Symposium in Management - Management During and after the Economic Crisis (SIM), OCT 09-10, 2015, Timisoara, ROMANIA, ISSN: 1877-0428, Published: 2016;
182. Lupei, A., Stanciu, L. Application for UDS Automated Test Generation, 2016 IEEE 11TH INTERNATIONAL SYMPOSIUM ON APPLIED COMPUTATIONAL INTELLIGENCE AND INFORMATICS (SACI), Pages: 85-88, 11th IEEE International Symposium on Applied Computational Intelligence and Informatics (SACI), MAY 12-14, 2016, Timisoara, ROMANIA, ISBN: 978-1-5090-2380-6, Published: 2016;
183. Lute, M. Classic and New Materials Used for Structural Rehabilitation. Case Study, INTERNATIONAL CONFERENCE ON INNOVATIVE RESEARCH - ICIR EUROINVENT 2016, Book Series: IOP Conference Series-Materials Science and Engineering, Volume: 133, Article Number: UNSP 012033, EUROINVENT International Conference on Innovative Research (ICIR Euroinvent), MAY 19-20, 2016, Iasi, ROMANIA, ISSN: 1757-8981, Published: 2016;
184. Lute, M. Mixed Consolidation Solution for a Reinforced Concrete Structure, INTERNATIONAL CONFERENCE ON INNOVATIVE RESEARCH - ICIR EUROINVENT 2016, Book Series: IOP Conference Series-Materials Science and Engineering, Volume: 133, Article Number: UNSP 012022, EUROINVENT International Conference on Innovative Research (ICIR Euroinvent), MAY 19-20, 2016, Iasi, ROMANIA, ISSN: 1757-8981, Published: 2016;
185. Lute, M. STUDY OF A ONE HUNDRED YEARS STRUCTURAL CHANGES REFLECTED IN ONE BUILDING, NANO, BIO AND GREEN - TECHNOLOGIES FOR A SUSTAINABLE FUTURE CONFERENCE PROCEEDINGS, SGEM 2016, VOL II, Book Series: International Multidisciplinary Scientific GeoConference-SGEM, Pages: 707-714, 16th International Multidisciplinary Scientific Geoconference (SGEM 2016), JUN 30-JUL 06, 2016, Albena, BULGARIA, ISSN: 1314-2704, ISBN: 978-619-7105-69-8, Published: 2016;
186. Lute, M., Lute, M. OPTIMIZATION OF THERMAL INSULATION-MAIN ASPECT FOR ENERGY AND COST SAVINGS, NANO, BIO AND GREEN - TECHNOLOGIES FOR A SUSTAINABLE FUTURE CONFERENCE PROCEEDINGS, SGEM 2016, VOL II, Book Series: International Multidisciplinary Scientific GeoConference-SGEM, Pages: 651-657, 16th International Multidisciplinary Scientific Geoconference (SGEM 2016), JUN 30-JUL 06, 2016, Albena, BULGARIA, ISSN: 1314-2704, ISBN: 978-619-7105-69-8, Published: 2016;
187. Lute, M., Marincu, A. GREEN DEVELOPMENT OF CITY AREAS BY USING INDUSTRIAL HERITAGE AND MODERN APPROACHES, NANO, BIO AND GREEN - TECHNOLOGIES FOR A SUSTAINABLE FUTURE CONFERENCE PROCEEDINGS, SGEM 2016, VOL II, Book Series: International Multidisciplinary Scientific GeoConference-SGEM, Pages: 579-586, 16th International Multidisciplinary Scientific Geoconference (SGEM 2016), JUN 30-JUL 06, 2016, Albena, BULGARIA, ISSN: 1314-2704, ISBN: 978-619-7105-69-8, Published: 2016;
188. Madescu, G., Biriescu, M., Tutelea, L.N., Mot, M., Svoboda, M., Boldea, I. Experimental Investigation of Rotor Currents Distribution in Three Phase Induction Motors with symmetrical Squirrel Cage at Standstill, 2016 XXII INTERNATIONAL CONFERENCE ON ELECTRICAL MACHINES (ICEM), Pages: 338-343, 22nd International Conference on Electrical Machines (ICEM), SEP 04-07, 2016, Lausanne, SWITZERLAND, ISBN: 978-1-5090-2538-1, Published: 2016;
189. Madescu, G., Mot, M., Greconici, M., Biriescu, M., Vesa, D. Performances Analysis of an Induction Motor With Stator Slot Magnetic Wedges, 2016 INTERNATIONAL CONFERENCE ON APPLIED AND THEORETICAL ELECTRICITY (ICATE), Book Series: International Conference on Applied and Theoretical Electricity, International Conference on Applied and Theoretical Electricity (ICATE), OCT 06-08, 2016, Craiova, ROMANIA, ISSN: 2376-4163, ISBN: 978-1-4673-8562-6, Published: 2016;
190. Maduta, S.M., Caleanu, C.D. Steps in Deployment and Development of Convolutional Neural Network based Applications, 2016 12TH IEEE INTERNATIONAL SYMPOSIUM ON ELECTRONICS AND TELECOMMUNICATIONS (ISETC'16), Pages: 247-251, 12th IEEE International Symposium on Electronics and Telecommunications (ISETC), OCT 27-28, 2016, Timisoara, ROMANIA, ISBN: 978-1-5090-3748-3, Published: 2016;

191. Man, T.E., Beilicci, R., Pelea, G.N., Leucuta, G.C., Balaj, C., Tamas, M. Sprinkler Irrigation Facilities on 800 Ha in Otelec (Iohanesfeld) and Giulvaz (Ivanda), MODERN TECHNOLOGIES FOR THE 3RD MILLENNIUM, Pages: 125-130, 15th National Technical-Scientific Conference on Modern Technologies for the 3rd Millennium, NOV 27-28, 2015, Oradea, ROMANIA, ISBN: 978-88-7587-724-8, Published: 2016;
192. Manitiu, C.M., Marcu, M. Study on Computer Usage Patterns Depending on End Users' Contexts, 2016 IEEE 11TH INTERNATIONAL SYMPOSIUM ON APPLIED COMPUTATIONAL INTELLIGENCE AND INFORMATICS (SACI), Pages: 19-24, 11th IEEE International Symposium on Applied Computational Intelligence and Informatics (SACI), MAY 12-14, 2016, Timisoara, ROMANIA, ISBN: 978-1-5090-2380-6, Published: 2016;
193. Marcauteanu, C., Sinescu, C., Negrutiu, M.L., Stoica, E.T., Topala, F., Duma, V.F., Bradu, A., Podoleanu, A.G. Evaluation of Tizian overlays by means of a swept source optical coherence tomography system, HIGH-END MEDICINE BASED ON LASER AND BIOTECHNOLOGIES, Book Series: Proceedings of SPIE, Volume: 9670, Article Number: 96700X, 5th Congress of the World-Federation-for-Laser-Dentistry / 6th International Conference on Lasers in Medicine, MAY 07-09, 2015, Bucharest, ROMANIA, ISSN: 0277-786X, ISBN: 978-1-62841-893-4, Published: 2016;
194. Marcus, S., Frigura-Iliasa, M., Vatau, D., Matiu-Iovan, L. New Interpolation Tools for Digital Signal Processing, 2016 INTERNATIONAL CONFERENCE ON INFORMATION AND DIGITAL TECHNOLOGIES (IDT), Pages: 266-270, International Conference on Information and Digital Technologies (IDT), JUL 05-07, 2016, Rzeszow, POLAND, ISBN: 978-1-4673-8860-3, Published: 2016;
195. Marossy, Z., Beilicci, R., Beilicci, E., Visescu, M. ADVANCE HYDRAULIC MODELING OF IRRIGATION CHANNEL CP3, IN IRRIGATION SYSTEM TEBA - TIMISAT, ROMANIA, TIMIS COUNTY, WATER, RESOURCES, FOREST, MARINE AND OCEAN ECOSYSTEMS CONFERENCE PROCEEDINGS, VOL I, Book Series: International Multidisciplinary Scientific GeoConference-SGEM, Pages: 39-46, 16th International Multidisciplinary Scientific Geoconference (SGEM 2016), JUN 30-JUL 06, 2016, Albena, BULGARIA, ISSN: 1314-2704, ISBN: 978-619-7105-61-2, Published: 2016;
196. Marossy, Z., Beilicci, E., Beilicci, R., Carabet, A., Stefanescu, C. MATHEMATICAL MODELING OF EUTROPHICATION PROCESSES IN GOZNA AND SECU RESERVOIRES, ECOLOGY, ECONOMICS, EDUCATION AND LEGISLATION CONFERENCE PROCEEDINGS, SGEM 2016, VOL II, Book Series: International Multidisciplinary Scientific GeoConference-SGEM, Pages: 553-559, 16th International Multidisciplinary Scientific Geoconference (SGEM 2016), JUN 30-JUL 06, 2016, Albena, BULGARIA, ISSN: 1314-2704, ISBN: 978-619-7105-66-7, Published: 2016;
197. Marossy, Z., Beilicci, R., Beilicci, E., Visescu, M. Head Loss Modelling with Advanced Hydroinformatic Tool in Sprinkler Irrigation Facilities, Study Case: Sprinkler Irrigation Facilities on 400 ha in Iohanesfeld, Romania, WORLD MULTIDISCIPLINARY CIVIL ENGINEERING-ARCHITECTURE-URBAN PLANNING SYMPOSIUM 2016, WMCAUS 2016, Book Series: Procedia Engineering, Volume: 161, Pages: 1939-1943, World Multidisciplinary Civil Engineering-Architecture-Urban Planning Symposium (WMCAUS), JUN 13-17, 2016, Prague, CZECH REPUBLIC, Published: 2016;
198. Mateas, M., Argesanu, V., Mateas, I., Farkas, A. About the use of stabilometry to evaluate social integration predictors, SOCIAL INCLUSION AND EQUAL OPPORTUNITIES (SIEO 2016), Pages: 155-162, International Conference on Social Inclusion and Equal Opportunities (SIEO), OCT 26-28, 2016, Timisoara, ROMANIA, ISBN: 978-88-95922-75-1, Published: 2016;
199. Mateas, M., Argesanu, V., Mateas, I., Farkas, A. Considerations about the use of stabilometry for the psychological evaluation, PROBATION AS A FIELD OF STUDY AND RESEARCH: FROM PERSON TO SOCIETY, Pages: 126-131, 5th International Conference on Multidisciplinary Perspectives in the Quasi-Coercive Treatment of Offenders (SPECT), MAR 31-APR 01, 2016, Timisoara, ROMANIA, ISBN: 978-88-95922-68-3, Published: 2016;
200. Matekovits, L., De Sabata, A., Lipan, O., Silaghi, A.M., Baderca, M.S., Buta, P.A. Effect of Geometry Modulation on the Full Dispersion Diagram of a 2D Periodic Structure Built in Stripline Technology, 2016 IEEE ANTENNAS AND PROPAGATION SOCIETY INTERNATIONAL SYMPOSIUM, Book Series: IEEE Antennas and Propagation Society International Symposium, Pages: 1961-1962, IEEE-Antennas-and-Propagation-Society International Symposium, JUN 26-JUL 01, 2016, Fajardo, PR, ISSN: 1522-3965, ISBN: 978-1-5090-2886-3, Published: 2016;
201. Matlak, S., Bogdan, R. Reducing Energy Consumption in Home Automation based on STM32F407 Microcontroller, 2016 24TH TELECOMMUNICATIONS FORUM (TELFOR), Pages: 273-276, 24th Telecommunications Forum (TELFOR), NOV 22-23, 2016, Belgrade, SERBIA, ISBN: 978-1-5090-4086-5, Published: 2016;

202. Melita, N.T., Holban, S. An Incomplete Dominance Genetic Algorithm Approach to Microarray Data Analysis, 2016 IEEE 12TH INTERNATIONAL CONFERENCE ON INTELLIGENT COMPUTER COMMUNICATION AND PROCESSING (ICCP), Book Series: IEEE International Conference on Intelligent Computer Communication and Processing ICCP, Pages: 147-151, 12th IEEE International Conference on Intelligent Computer Communication and Processing (ICCP), SEP 08-10, 2016, Cluj Napoca, ROMANIA, ISSN: 2065-9946, ISBN: 978-1-5090-3898-5, Published: 2016;
203. Miclea, S., Izvercianu, M. THE LEGACY MARKETING CONCEPT: WHAT IS IT AND HOW DOES IT WORK?, FROM MANAGEMENT OF CRISIS TO MANAGEMENT IN A TIME OF CRISIS, Book Series: Review of Management and Economic Engineering International Management Conference, Pages: 395-402, 5th Review of Management and Economic Engineering International Management Conference, SEP 22-24, 2016, Tech Univ Cluj Napoca, Cluj Napoca, ROMANIA, ISSN: 2247-8639, Published: 2016;
204. Micu, L.M., Mitelea, I., Bordeasu, I., Craciunescu, C.M., Oanca, O.V. IMPROVEMENT IN CAVITATION EROSION RESISTANCE OF X2CrNi-MoN22-5-3 DUPLEX STAINLESS STEEL BY LASER BEAM NITRATION, METAL 2016: 25TH ANNIVERSARY INTERNATIONAL CONFERENCE ON METALLURGY AND MATERIALS, Pages: 789-794, 25th Anniversary International Conference on Metallurgy and Materials (METAL), MAY 25-27, 2016, Brno, CZECH REPUBLIC, ISBN: 978-80-87294-67-3, Published: 2016;
205. Mihaicuta, S., Reisz, D., Dan, R., Udrescu, L., Topirceanu, A., Udrescu, M. STOP Bang versus SAS(Score): prediction strategy in obstructive sleep apnea syndrome, JOURNAL OF SLEEP RESEARCH, Meeting Abstract: P816, Volume: 25, Special Issue: SI, Pages: 346-346, 23rd Congress of the European-Sleep-Research-Society, SEP 13-16, 2016, Bologna, ITALY, ISSN: 0962-1105, eISSN: 1365-2869, Supplement: 1, Published: SEP 2016;
206. Mihaicuta, S., Udrescu, M., Topirceanu, A., Sbarcea, L., Udrescu, L. Gender Phenotyping Of COPD Patients Using Complex Network Analysis, AMERICAN JOURNAL OF RESPIRATORY AND CRITICAL CARE MEDICINE, Meeting Abstract: A3521, Volume: 193, International Conference of the American-Thoracic-Society (ATS), MAY 13-18, 2016, San Francisco, CA, ISSN: 1073-449X, eISSN: 1535-4970, Published: 2016;
207. Milincu, C., Racolta, A., Giurea, D. THE ANALYSIS OF PET BOTTLE REUSE AS GROUND FLOOR SLAB THERMAL INSULATION, NANO, BIO AND GREEN - TECHNOLOGIES FOR A SUSTAINABLE FUTURE CONFERENCE PROCEEDINGS, SGEM 2016, VOL II, Book Series: International Multidisciplinary Scientific GeoConference-SGEM, Pages: 739-746, 16th International Multidisciplinary Scientific Geoconference (SGEM 2016), JUN 30-JUL 06, 2016, Albena, BULGARIA, ISSN: 1314-2704, ISBN: 978-619-7105-69-8, Published: 2016;
208. Milotin, R., Lelea, D. The Passive Mixing Phenomena in Microtubes with Baffle Configuration, 9TH INTERNATIONAL CONFERENCE INTERDISCIPLINARITY IN ENGINEERING, INTER-ENG 2015, Book Series: Procedia Technology, Volume: 22 Pages: 243-250, 9th International Conference on Interdisciplinarity in Engineering (INTER-ENG), OCT 08-09, 2015, Univ Tirgu Mure, Fac Engn, Tirgu Mures, ROMANIA, ISSN: 2212-0173, Published: 2016;
209. Mircea, B. High frequency resolution harmonic analysis, 2016 13TH INTERNATIONAL CONFERENCE ON DEVELOPMENT AND APPLICATION SYSTEMS (DAS 2016), Pages: 203-206, 13th International Conference on Development and Application Systems (DAS), MAY 19-21, 2016, Suceava, ROMANIA, ISBN: 978-1-5090-1993-9, Published: 2016;
210. Mircea, B. Revision of the Sampling Theorem, 2016 IEEE 22ND INTERNATIONAL SYMPOSIUM FOR DESIGN AND TECHNOLOGY AND ELECTRONIC PACKAGING (SIITME), Pages: 66-69, 22nd IEEE International Symposium for Design and Technology in Electronic Packaging (SIITME), OCT 20-23, 2016, Oradea, ROMANIA, ISBN: 978-1-5090-4446-7, Published: 2016;
211. Mirea, M., Ciopec, A. THE STABILITY VERIFICATION OF THE RETAINING STRUCTURE OF AN UNSTABLE SLOPE, 16TH INTERNATIONAL MULTIDISCIPLINARY SCIENTIFIC GEOCONFERENCE, SGEM 2016: SCIENCE AND TECHNOLOGIES IN GEOLOGY, EXPLORATION AND MINING, VOL I, Book Series: International Multidisciplinary Scientific GeoConference-SGEM, Pages: 1037-1043, 16th International Multidisciplinary Scientific Geoconference (SGEM 2016), JUN 30-JUL 06, 2016, Albena, BULGARIA, ISSN: 1314-2704, ISBN: 978-619-7105-55-1, Published: 2016;
212. Mischie, S. On teaching Raspberry Pi for Undergraduate University Programmes, 2016 12TH IEEE INTERNATIONAL SYMPOSIUM ON ELECTRONICS AND TELECOMMUNICATIONS (ISETC'16), Pages: 149-152, 12th IEEE International Symposium on Electronics and Telecommunications (ISETC), OCT 27-28, 2016, Timisoara, ROMANIA, ISBN: 978-1-5090-3748-3, Published: 2016;
213. Mocofan, M. LEARNING BY GAMES; A STUDY CASE OF THE COFFE PROJECT IMPLEMENTATION IN ROMANIA, ELEARNING VISION 2020!, VOL I, Book Series: eLearning and Software for Education, Pages: 529-533, 12th International Scientific Conference on eLearning and Software for Education (eLSE), APR 21-22, 2016, Bucharest, ROMANIA, ISSN: 2066-026X, Published: 2016;

214. Molnar, L., Gontean, A. Fault Simulation Methodes, 2016 12TH IEEE INTERNATIONAL SYMPOSIUM ON ELECTRONICS AND TELECOMMUNICATIONS (ISETC'16), Pages: 194-197, 12th IEEE International Symposium on Electronics and Telecommunications (ISETC), OCT 27-28, 2016, Timisoara, ROMANIA, ISBN: 978-1-5090-3748-3, Published: 2016;
215. Molnar, L., Gontean, A. Functional Simulation Methodes, 2016 12TH IEEE INTERNATIONAL SYMPOSIUM ON ELECTRONICS AND TELECOMMUNICATIONS (ISETC'16), Pages: 198-201, 12th IEEE International Symposium on Electronics and Telecommunications (ISETC), OCT 27-28, 2016, Timisoara, ROMANIA, ISBN: 978-1-5090-3748-3, Published: 2016;
216. Moscovici, A.M., Banescu, O.A. NOISE MAPS AND SPATIAL SUSTAINABLE DEVELOPMENT IN URBAN AREAS, NANO, BIO AND GREEN - TECHNOLOGIES FOR A SUSTAINABLE FUTURE CONFERENCE PROCEEDINGS, SGEM 2016, VOL II, Book Series: International Multidisciplinary Scientific GeoConference-SGEM, Pages: 645-650, 16th International Multidisciplinary Scientific Geoconference (SGEM 2016), JUN 30-JUL 06, 2016, Albena, BULGARIA, ISSN: 1314-2704, ISBN: 978-619-7105-69-8, Published: 2016;
217. Munteanu, D., Ionel, R. Voice-Controlled Smart Assistive Device for Visually Impaired Individuals, 2016 12TH IEEE INTERNATIONAL SYMPOSIUM ON ELECTRONICS AND TELECOMMUNICATIONS (ISETC'16), Pages: 186-+, 12th IEEE International Symposium on Electronics and Telecommunications (ISETC), OCT 27-28, 2016, Timisoara, ROMANIA, ISBN: 978-1-5090-3748-3, Published: 2016;
218. Murvay, P.S., Matei, A., Solomon, C., Groza, B. Development of an AUTOSAR Compliant Cryptographic Library on State-of-the-Art Automotive Grade Controllers, PROCEEDINGS OF 2016 11TH INTERNATIONAL CONFERENCE ON AVAILABILITY, RELIABILITY AND SECURITY, (ARES 2016), Pages: 117-126, 11th International Conference on Availability, Reliability and Security (ARES), AUG 31-SEP 02, 2016, Salzburg, AUSTRIA, ISBN: 978-1-5090-0990-9, Published: 2016;
219. Nafornta, C., Isar, A., Nelson, J.D.B. Denoising of Single Look Complex SAR Images using Hurst Estimation, 2016 12TH IEEE INTERNATIONAL SYMPOSIUM ON ELECTRONICS AND TELECOMMUNICATIONS (ISETC'16), Pages: 333-338, 12th IEEE International Symposium on Electronics and Telecommunications (ISETC), OCT 27-28, 2016, Timisoara, ROMANIA, ISBN: 978-1-5090-3748-3, Published: 2016;
220. Nagy, D., Racz, E., Varga, A., Ruf, H., Neuchel, E.R. Comparison of Electric Current-Voltage Characteristics and Maximal Power Point Values of Differently and Artificially Aged Solar Panels, 2016 IEEE 11TH INTERNATIONAL SYMPOSIUM ON APPLIED COMPUTATIONAL INTELLIGENCE AND INFORMATICS (SACI), Pages: 295-300, 11th IEEE International Symposium on Applied Computational Intelligence and Informatics (SACI), MAY 12-14, 2016, Timisoara, ROMANIA, ISBN: 978-1-5090-2380-6, Published: 2016;
221. Narita, A., Mosoarca, M., Modena, C., da Porto, F., Munari, M., Taffarel, S., Marson, C., Valotto, C., Roverato, M. Behavior of Historic Buildings in Zones with Moderate Seismic Activity. Case Study: Banat Region, Romania, WORLD MULTIDISCIPLINARY CIVIL ENGINEERING-ARCHITECTURE-URBAN PLANNING SYMPOSIUM 2016, WMCAUS 2016, Book Series: Procedia Engineering, Volume: 161, Pages: 729-737, World Multidisciplinary Civil Engineering-Architecture-Urban Planning Symposium (WMCAUS), JUN 13-17, 2016, Prague, CZECH REPUBLIC, ISSN: 1877-7058, Published: 2016;
222. Ndogmo, J., Mensinger, M., Both, I. Buckling behavior of stiffened plate under biaxial compression and shear, BRIDGES IN DANUBE BASIN 2016 - NEW TRENDS IN BRIDGE ENGINEERING AND EFFICIENT SOLUTION FOR LARGE AND MEDIUM SPAN BRIDGES, Book Series: Procedia Engineering, Volume: 156, Pages: 272-279, 9th International Conference on Bridges in Danube Basin, SEP 30-OCT 01, 2016, Zilina, SLOVAKIA, ISSN: 1877-7058, Published: 2016;
223. Negrea, P., Minzatu, V., Ciopec, M., Negrea, A. REMOVAL OF DYES AND HEAVY METALS FROM WASTEWATER USING ELECTROCOAGULATION PROCESS, NANO, BIO AND GREEN - TECHNOLOGIES FOR A SUSTAINABLE FUTURE CONFERENCE PROCEEDINGS, SGEM 2016, VOL III, Book Series: International Multidisciplinary Scientific GeoConference-SGEM, Pages: 465-472, 16th International Multidisciplinary Scientific Geoconference (SGEM 2016), JUN 30-JUL 06, 2016, Albena, BULGARIA, ISSN: 1314-2704, ISBN: 978-619-7105-79-7, Published: 2016;
224. Negrulescu, I.C., Baldea, M. IGNORED BACKGROUNDS IN SINGLE FAMILY HOUSE PLANNING. PAST DWELLING EXPERIENCE, SGEM 2016, BK 4: ARTS, PERFORMING ARTS, ARCHITECTURE AND DESIGN CONFERENCE PROCEEDINGS, VOL III, Book Series: International Multidisciplinary Scientific Conferences on Social Sciences and Arts, Pages: 375-382, 3rd International Multidisciplinary Scientific Conference on Social Sciences and Arts, SGEM 2016, AUG 24-30, 2016, Albena, BULGARIA, ISSN: 2367-5659, ISBN: 978-619-7105-78-0, Published: 2016;
225. Negrut, M.L., Mihartescu, A.A. Market Study on Performance of the Marketing Function in Small and Medium Enterprises in Romania, 13TH INTERNATIONAL SYMPOSIUM IN MANAGEMENT: MANAGEMENT DURING AND AFTER THE ECONOMIC CRISIS, Book Series: Procedia Social and Behavioral Sciences, Volume: 221, Pages: 119-125, 13th International Symposium in Management - Management During and after the Economic Crisis (SIM), OCT 09-10, 2015, Timisoara, ROMANIA, ISSN: 1877-0428, Published: 2016;

226. Negrutiu, M.L., Sinescu, C., Bortun, C.M., Levai, M.C., Topala, F.I., Craciunescu, E.L., Cojocariu, A.C., Duma, V.F., Podoleanu, A.G. Assessment of Dental Plaque by Optoelectronic Methods, HIGH-END MEDICINE BASED ON LASER AND BIOTECHNOLOGIES, Book Series: Proceedings of SPIE, Volume: 9670, Article Number: 96700W, 5th Congress of the World-Federation-for-Laser-Dentistry / 6th International Conference on Lasers in Medicine, MAY 07-09, 2015, Bucharest, ROMANIA, ISSN: 0277-786X, ISBN: 978-1-62841-893-4, Published: 2016;
227. Neicu, M.S., Savii, G.G. Keyboard emulation with a voice interpreter of English for Romanian language users, 2016 12TH IEEE INTERNATIONAL SYMPOSIUM ON ELECTRONICS AND TELECOMMUNICATIONS (ISETC'16), Pages: 215-218, 12th IEEE International Symposium on Electronics and Telecommunications (ISETC), OCT 27-28, 2016, Timisoara, ROMANIA, ISBN: 978-1-5090-3748-3, Published: 2016;
228. Nguyen-Ly, T.T., Le, K., Savin, V., Declercq, D., Ghaffari, F., Boncalo, O. Non-Surjective Finite Alphabet Iterative Decoders, 2016 IEEE INTERNATIONAL CONFERENCE ON COMMUNICATIONS (ICC), Book Series: IEEE International Conference on Communications, IEEE International Conference on Communications (ICC), MAY 22-27, 2016, Kuala Lumpur, MALAYSIA, ISSN: 1550-3607, ISBN: 978-1-4799-6664-6, Published: 2016;
229. Nicola, S., Stoicu-Tivadar, L., Virag, I., Crisan-Vida, M. Leap motion supporting medical education, 2016 12TH IEEE INTERNATIONAL SYMPOSIUM ON ELECTRONICS AND TELECOMMUNICATIONS (ISETC'16), Pages: 153-156, 12th IEEE International Symposium on Electronics and Telecommunications (ISETC), OCT 27-28, 2016, Timisoara, ROMANIA, ISBN: 978-1-5090-3748-3, Published: 2016;
230. Nimara, S., Boncalo, O., Amaricai, A., Popa, M. FPGA Architecture of Multi-Codeword LDPC Decoder With Efficient BRAM Utilization, 2016 IEEE 19TH INTERNATIONAL SYMPOSIUM ON DESIGN AND DIAGNOSTICS OF ELECTRONIC CIRCUITS & SYSTEMS (DDECS), Book Series: IEEE International Symposium on Design and Diagnostics of Electronic Circuits & Systems, Pages: 52-55, IEEE 19th International Symposium on Design and Diagnostics of Electronic Circuits & Systems (DDECS), APR 20-22, 2016, Kosice, SLOVAKIA, ISSN: 2334-3133, ISBN: 978-1-5090-2467-4, Published: 2016;
231. Nitu, M., Matache, M., Vladut, V., Kiss, I. RESEARCHES IN OPTIMIZING THE WORKING PROCESS OF MACHINERY USED FOR TREATMENT OF FIELD CROPS, 15TH INTERNATIONAL SCIENTIFIC CONFERENCE: ENGINEERING FOR RURAL DEVELOPMENT, Book Series: Engineering for Rural Development, Volume: 15, Pages: 832-838, 15th International Scientific Conference on Engineering for Rural Development, MAY 25-27, 2016, Jelgava, LATVIA, ISSN: 1691-3043, Published: 2016;
232. Orzen, S.N., Stratulat, M., Babii, S., Cosovan, C. Connectivity for Routing Persistent Connections, 2016 12TH IEEE INTERNATIONAL SYMPOSIUM ON ELECTRONICS AND TELECOMMUNICATIONS (ISETC'16), Pages: 99-102, 12th IEEE International Symposium on Electronics and Telecommunications (ISETC), OCT 27-28, 2016, Timisoara, ROMANIA, ISBN: 978-1-5090-3748-3, Published: 2016;
233. Orzen, S.N., Stratulat, M., Babii, S., Cosovan, C. Markov Chains State Transitions for Reliable Persistent Routing, INES 2016 20th Jubilee IEEE International Conference on Intelligent Engineering Systems, Book Series: IEEE International Conference on Intelligent Engineering Systems, Pages: 101-106, 20th Jubilee IEEE International Conference on Intelligent Engineering Systems (INES), JUN 30-JUL 02, 2016, Budapest, HUNGARY, ISSN: 1562-5850, ISBN: 978-1-5090-1216-9, Published: 2016;
234. Osaci, M., Cacciola, M. Theoretical studies to elucidate the influence of magnetic dipolar interactions occurring in the magnetic nanoparticle systems, for biomedical applications, INTERNATIONAL CONFERENCE ON APPLIED SCIENCES 2015 (ICAS2015), Book Series: IOP Conference Series-Materials Science and Engineering, Volume: 106, Article Number: 012004, International Conference on Applied Sciences (ICAS), JUN 03-05, 2015, Military Econ Acad Wuhan, Wuhan, PEOPLES R CHINA, ISSN: 1757-8981, Published: 2016;
235. Pacurar, C., Heput, T., Ardelean, M. Optimizing the Structure of Metal Load in order to Reduce Electricity Consumption in the Production of Steel, PROCEEDINGS OF THE INTERNATIONAL CONFERENCE ON NUMERICAL ANALYSIS AND APPLIED MATHEMATICS 2015 (ICNAAM-2015), Book Series: AIP Conference Proceedings, Volume: 1738, Article Number: 080006, International Conference on Numerical Analysis and Applied Mathematics (ICNAAM), SEP 23-29, 2015, Rhodes, GREECE, ISSN: 0094-243X, ISBN: 978-0-7354-1392-4, Published: 2016;
236. Pacurar, C., Heput, T., Crisan, E. The Influence of the Structure of the Metal Load Removal from Liquid Steel in Electric Arc Furnaces, PROCEEDINGS OF THE INTERNATIONAL CONFERENCE ON NUMERICAL ANALYSIS AND APPLIED MATHEMATICS 2015 (ICNAAM-2015), Book Series: AIP Conference Proceedings, Volume: 1738, Article Number: 080007, International Conference on Numerical Analysis and Applied Mathematics (ICNAAM), SEP 23-29, 2015, Rhodes, GREECE, ISSN: 0094-243X, ISBN: 978-0-7354-1392-4, Published: 2016;

237. Panoiu, C., Rob, R., Panoiu, M. Power variation during the functioning of nonlinear load, INTERNATIONAL CONFERENCE ON APPLIED SCIENCES 2015 (ICAS2015), Book Series: IOP Conference Series-Materials Science and Engineering, Volume: 106, Article Number: 012022, International Conference on Applied Sciences (ICAS), JUN 03-05, 2015, Military Econ Acad Wuhan, Wuhan, PEOPLES R CHINA, ISSN: 1757-8981, Published: 2016;
238. Panoiu, M., Rat, C.L., Panoiu, C. Study on road sign recognition in LabVIEW, INTERNATIONAL CONFERENCE ON APPLIED SCIENCES 2015 (ICAS2015), Book Series: IOP Conference Series-Materials Science and Engineering, Volume: 106, Article Number: 012009, International Conference on Applied Sciences (ICAS), JUN 03-05, 2015, Military Econ Acad Wuhan, Wuhan, PEOPLES R CHINA, ISSN: 1757-8981, Published: 2016;
239. Paschek, D., Draghici, A., Rennung, F., Trusculescu, A.E. INDIVIDUAL RISK EARLY WARNING SYSTEMS AS A MANAGEMENT INSTRUMENT TO HANDLE CRISES, FROM MANAGEMENT OF CRISIS TO MANAGEMENT IN A TIME OF CRISIS, Book Series: Review of Management and Economic Engineering International Management Conference, Pages: 140-147, 5th Review of Management and Economic Engineering International Management Conference, SEP 22-24, 2016, Tech Univ Cluj Napoca, Cluj Napoca, ROMANIA, ISSN: 2247-8639, Published: 2016;
240. Pater, F., Amaricai, A. Probability Density Function Modeling for Sub-Powered Interconnects, PROCEEDINGS OF THE INTERNATIONAL CONFERENCE ON NUMERICAL ANALYSIS AND APPLIED MATHEMATICS 2015 (ICNAAM-2015), Book Series: AIP Conference Proceedings, Volume: 1738, Article Number: 350001, International Conference on Numerical Analysis and Applied Mathematics (ICNAAM), SEP 23-29, 2015, Rhodes, GREECE, ISSN: 0094-243X, ISBN: 978-0-7354-1392-4, Published: 2016;
241. Pater, L., Izvercianu, M., Ivascu, L. EVOLUTION OF THE SUSTAINABILITY CONCEPT, FROM MANAGEMENT OF CRISIS TO MANAGEMENT IN A TIME OF CRISIS, Book Series: Review of Management and Economic Engineering International Management Conference, Pages: 206-213, 5th Review of Management and Economic Engineering International Management Conference, SEP 22-24, 2016, Tech Univ Cluj Napoca, Cluj Napoca, ROMANIA, ISSN: 2247-8639, Published: 2016;
242. Pater, L., Miclea, S., Izvercian, M. Statistical Testing of the Association between Annual Turnover and Marketing Activities in SMEs Using χ^2 , PROCEEDINGS OF THE INTERNATIONAL CONFERENCE ON NUMERICAL ANALYSIS AND APPLIED MATHEMATICS 2015 (ICNAAM-2015), Book Series: AIP Conference Proceedings, Volume: 1738, Article Number: 350006, International Conference on Numerical Analysis and Applied Mathematics (ICNAAM), SEP 23-29, 2015, Rhodes, GREECE, ISSN: 0094-243X, ISBN: 978-0-7354-1392-4, Published: 2016;
243. Pater, L.R., Cristea, S.L. Systemic Definitions of Sustainability, Durability and Longevity, 13TH INTERNATIONAL SYMPOSIUM IN MANAGEMENT: MANAGEMENT DURING AND AFTER THE ECONOMIC CRISIS, Book Series: Procedia Social and Behavioral Sciences, Volume: 221, Pages: 362-371, 13th International Symposium in Management - Management During and after the Economic Crisis (SIM), OCT 09-10, 2015, Timisoara, ROMANIA, ISSN: 1877-0428, Published: 2016;
244. Patrascu, C., Muntean, N., Cornea, O., Hedes, A., Microgrid Laboratory for Educational and Research Purposes, 2016 IEEE 16TH INTERNATIONAL CONFERENCE ON ENVIRONMENT AND ELECTRICAL ENGINEERING (EEEIC), IEEE 16th International Conference on Environment and Electrical Engineering (EEEIC), JUN 07-10, 2016, Florence, ITALY, ISBN: 978-1-5090-2320-2, Published: 2016;
245. Paul, C., Borza, P., Todea, A., Peter, F. Sol-gel immobilized biocatalyst for continuous-flow enantioselective acylation, NEW BIOTECHNOLOGY, Meeting Abstract: P8-32, Volume: 33, Pages: S104-S104, ISSN: 1871-6784, eISSN: 1876-4347, Supplement: S, Published: JUL 25, 2016;
246. Pelea, G.N., Costescu, I.A., Man, T.E. Current Management Issues in Exploitation and Maintenance of Irrigation Systems in Western Part of Romania. Case Study of Uniform Application of Irrigation, WORLD MULTIDISCIPLINARY CIVIL ENGINEERING-ARCHITECTURE-URBAN PLANNING SYMPOSIUM 2016, WMCAUS 2016, Book Series: Procedia Engineering, Volume: 161, Pages: 1827-1832, World Multidisciplinary Civil Engineering-Architecture-Urban Planning Symposium (WMCAUS), JUN 13-17, 2016, Prague, CZECH REPUBLIC, ISSN: 1877-7058, Published: 2016;
247. Pelea, G.N., Costescu, I.A., Man, T.E., Nemes, N.S. PIVOT IRRIGATION SYSTEM IN MURESAN DRAINAGE SYSTEM, TIMIS COUNTY, ROMANIA, ECOLOGY, ECONOMICS, EDUCATION AND LEGISLATION CONFERENCE PROCEEDINGS, SGEM 2016, VOL I, Book Series: International Multidisciplinary Scientific GeoConference-SGEM, Pages: 509-516, 16th International Multidisciplinary Scientific Geoconference (SGEM 2016), JUN 30-JUL 06, 2016, Albena, BULGARIA, ISSN: 1314-2704, ISBN: 978-619-7105-65-0, Published: 2016;

248. Pelea, G.N., Costescu, I.M., Man, T.E., Coccoeanu, A. CURRENT MANAGEMENT ISSUES IN EXPLOITATION AND MAINTENANCE OF IRRIGATION SYSTEMS IN WESTERN PART OF ROMANIA. CASE STUDY OF WATER QUALITY FOR IRRIGATION, ECOLOGY, ECONOMICS, EDUCATION AND LEGISLATION CONFERENCE PROCEEDINGS, SGEM 2016, VOL I, Book Series: International Multidisciplinary Scientific GeoConference-SGEM, Pages: 223-230, 16th International Multidisciplinary Scientific Geoconference (SGEM 2016), JUN 30-JUL 06, 2016, Albena, BULGARIA, ISSN: 1314-2704, ISBN: 978-619-7105-65-0, Published: 2016;
249. Petcu, V., Boncalo, O., Amaricai, A., Savin, V. Variable Throughput LDPC Decoders Using SIMD-based Adaptive Quantization, 2016 39TH INTERNATIONAL CONFERENCE ON TELECOMMUNICATIONS AND SIGNAL PROCESSING (TSP), Pages: 425-428, 39th International Conference on Telecommunications and Signal Processing (TSP), JUN 27-29, 2016, Vienna, AUSTRIA, ISBN: 978-1-5090-1288-6, Published: 2016;
250. Petroman, C., Mirea, A., Lozici, A., Constantin, E.C., Marin, D., Merce, I. The Rural Educational Tourism at the Farm, 3RD GLOBAL CONFERENCE ON BUSINESS, ECONOMICS, MANAGEMENT AND TOURISM, Book Series: Procedia Economics and Finance, Volume: 39, Pages: 88-93, 3rd Global Conference on Business, Economics, Management and Tourism (BEMTUR), NOV 26-28, 2015, Rome, ITALY, ISSN: 2212-5671, Published: 2016;
251. Petroman, I., Varga, M., Constantin, E.C., Petroman, C., Momir, B., Turc, B., Merce, I. Agritourism: An Educational Tool for the Students with Agro-Food Profile, 3RD GLOBAL CONFERENCE ON BUSINESS, ECONOMICS, MANAGEMENT AND TOURISM, Book Series: Procedia Economics and Finance, Volume: 39, Pages: 83-87, 3rd Global Conference on Business, Economics, Management and Tourism (BEMTUR), NOV 26-28, 2015, Rome, ITALY, ISSN: 2212-5671, Published: 2016;
252. Petrut, I., Otesteanu, M., Balint, C., Budura, G. On the Uplink Performance in LTE Heterogeneous Network, 2016 INTERNATIONAL CONFERENCE ON COMMUNICATIONS (COMM 2016), Book Series: International Conference on Communications (ICC), Pages: 191-194, IEEE 11th International Conference on Communications (COMM), JUN 09-11, 2016, Bucharest, ROMANIA, ISBN: 978-1-4673-8197-0, Published: 2016;
253. Petrut, P.C., Amaricai, A., Boncalo, O. Configurable FPGA Architecture for Hardware-Software Merge Sorting, PROCEEDINGS OF THE 23RD INTERNATIONAL CONFERENCE ON MIXED DESIGN OF INTEGRATED CIRCUITS AND SYSTEMS (MIXDES 2016), Pages: 179-182, 23rd International Conference on Mixed Design of Integrated Circuits and Systems (MIXDES), JUN 23-25, 2016, Lodz, POLAND, ISBN: 978-8-3635-7808-4, Published: 2016;
254. Piccotin, A., Marsavina, L., Berto, F., Negru, R. Fracture parameters determination of polyurethane materials for application of SED criteria to notched components, 21ST EUROPEAN CONFERENCE ON FRACTURE, (ECF21), Book Series: Procedia Structural Integrity, Volume: 2, Pages: 1861-1869, 21st European Conference on Fracture (ECF), JUN 20-24, 2016, Catania, ITALY, ISSN: 2452-3216, Published: 2016;
255. Pinteaa, F.A., Iacob, I., Lacrama, L.D., Toma, C.I. Implication of Developing a Software Application as an Instrument in Administrating the Baum Test, THEORETICAL AND APPLIED IN PSYCHOLOGY (SICAP23): PSYCHOLOGY AND ONGOING DEVELOPMENT, Pages: 139-142, 23rd International Symposium on Theoretical and Applied in Psychology (SICAP) - Psychology and Ongoing Development, NOV 20-21, 2015, Timisoara, ROMANIA, ISBN: 978-88-7587-735-4, Published: 2016;
256. Pisleaga, M., Badaluta-Minda, C. The Flood Impact Assessment from Ilisua Catchment Area on the Environment, WORLD MULTIDISCIPLINARY CIVIL ENGINEERING-ARCHITECTURE-URBAN PLANNING SYMPOSIUM 2016, WMCAUS 2016, Book Series: Procedia Engineering, Volume: 161, Pages: 2168-2172, World Multidisciplinary Civil Engineering-Architecture-Urban Planning Symposium (WMCAUS), JUN 13-17, 2016, Prague, CZECH REPUBLIC, ISSN: 1877-7058, Published: 2016;
257. Pleava, R., Frent, S., Ardelean, C., Reisz, D., Udrescu, M., Udrescu, L., Gaita, D., Dan, R., Mihaicuta, S. Obstructive sleep apnea syndrome and chronic kidney disease-2 faces of metabolic disorder, JOURNAL OF SLEEP RESEARCH, Meeting Abstract: P830, Volume: 25 Special Issue: SI, Pages: 351-351, 23rd Congress of the European-Sleep-Research-Society, SEP 13-16, 2016, Bologna, ITALY, ISSN: 0962-1105, eISSN: 1365-2869, Supplement: 1, Published: SEP 2016;
258. Pleava, R., Frent, S., Ardelean, C., Reisz, D., Udrescu, M., Gaita, D., Mihaicuta, S. Gender distribution/differences and impact in patients with obstructive sleep apnea syndrome, JOURNAL OF SLEEP RESEARCH, Meeting Abstract: P451, Volume: 25, Special Issue: SI, Pages: 233-234, 23rd Congress of the European-Sleep-Research-Society, SEP 13-16, 2016, Bologna, ITALY, ISSN: 0962-1105, eISSN: 1365-2869, Supplement: 1, Published: SEP 2016;

259. Pop, A., Pop, A., Savu, D., Dolga, V. Machining operations using Yamaha YK 400 robot, 7TH INTERNATIONAL CONFERENCE ON ADVANCED CONCEPTS IN MECHANICAL ENGINEERING, Book Series: IOP Conference Series-Materials Science and Engineering, Volume: 147, Article Number: UNSP 012068, 7th International Conference on Advanced Concepts in Mechanical Engineering (ACME), JUN 09-10, 2016, Iasi, ROMANIA, ISSN: 1757-8981, Published: 2016;
260. Pop, F., Lovasz, E.C., Pop, C., Dolga, V. Dimensional synthesis of a leg mechanism, 7TH INTERNATIONAL CONFERENCE ON ADVANCED CONCEPTS IN MECHANICAL ENGINEERING, Book Series: IOP Conference Series-Materials Science and Engineering, Volume: 147, Article Number: UNSP 012083, 7th International Conference on Advanced Concepts in Mechanical Engineering (ACME), JUN 09-10, 2016, Iasi, ROMANIA, ISSN: 1757-8981, Published: 2016;
261. Popa, C.A. Lie Algebra-Valued Hopfield Neural Networks, 2015 17TH INTERNATIONAL SYMPOSIUM ON SYMBOLIC AND NUMERIC ALGORITHMS FOR SCIENTIFIC COMPUTING (SYNASC), Book Series: International Symposium on Symbolic and Numeric Algorithms for Scientific Computing, Pages: 212-215, 17th International Symposium on Symbolic and Numeric Algorithms for Scientific Computing (SYNASC), SEP 21-24, 2015, Timisoara, ROMANIA, ISSN: 2470-8801, ISBN: 978-1-5090-0461-4, Published: 2016;
262. Popa, C.A. Matrix-Valued Hopfield Neural Networks, ADVANCES IN NEURAL NETWORKS - ISNN 2016, Book Series: Lecture Notes in Computer Science, Volume: 9719, Pages: 127-134, 13th International Symposium on Neural Networks (ISNN), JUL 06-08, 2016, Saint Petersburg, RUSSIA, ISSN: 0302-9743, ISBN: 978-3-319-40663-3; 978-3-319-40662-6, Published: 2016;
263. Popa, C.A. Octonion-Valued Neural Networks, ARTIFICIAL NEURAL NETWORKS AND MACHINE LEARNING - ICANN 2016, PT I, Book Series: Lecture Notes in Computer Science, Volume: 9886, Pages: 435-443, 25th International Conference on Artificial Neural Networks (ICANN), SEP 06-09, 2016, Barcelona, SPAIN, ISSN: 0302-9743, ISBN: 978-3-319-44778-0; 978-3-319-44777-3, Published: 2016;
264. Popa, C.A. Scaled Conjugate Gradient Learning for Quaternion-Valued Neural Networks, NEURAL INFORMATION PROCESSING, ICONIP 2016, PT III, Book Series: Lecture Notes in Computer Science, Volume: 9949, Pages: 243-252, 23rd International Conference on Neural Information Processing (ICONIP), OCT 16-21, 2016, Kyoto, JAPAN, ISSN: 0302-9743, ISBN: 978-3-319-46675-0; 978-3-319-46674-3, Published: 2016;
265. Popa, E., Pascu, L., Socalici, A., Lascutoni, A. Industrial research on the quality of brake shoes meant for rolling stock, INTERNATIONAL CONFERENCE ON APPLIED SCIENCES 2015 (ICAS2015), Book Series: IOP Conference Series-Materials Science and Engineering, Volume: 106, Article Number: 012016, International Conference on Applied Sciences (ICAS), JUN 03-05, 2015, Military Econ Acad Wuhan, Wuhan, PEOPLES R CHINA, ISSN: 1757-8981, Published: 2016;
266. Popa, G.N., Dinis, C.M., Deaconu, S.I. Numerical Simulations of the Electric Parameters of the Plate-Type Electrostatic Precipitators Supplied with DC Voltage, PROCEEDINGS OF THE 2016 INTERNATIONAL CONFERENCE AND EXPOSITION ON ELECTRICAL AND POWER ENGINEERING (EPE 2016), Book Series: International Conference and Exposition on Electrical and Power Engineering, Pages: 75-78, 9th International Conference and Exposition on Electrical and Power Engineering (EPE), OCT 20-22, 2016, Iasi, ROMANIA, ISSN: 2471-6855, ISBN: 978-1-5090-6128-0, Published: 2016;
267. Popa, G.N., Dinis, C.M., Deaconu, S.I., Maksay, S., Popa, I. Modelling of some parameters from thermoelectric power plants, INTERNATIONAL CONFERENCE ON APPLIED SCIENCES 2015 (ICAS2015), Book Series: IOP Conference Series-Materials Science and Engineering, Volume: 106, Article Number: 012011, International Conference on Applied Sciences (ICAS), JUN 03-05, 2015, Military Econ Acad Wuhan, Wuhan, PEOPLES R CHINA, ISSN: 1757-8981, Published: 2016;
268. Popa, I., Popa, G.N., Dinis, C.M., Deaconu, S.I. Astable multivibrator circuits made with low capacity PLC, INTERNATIONAL CONFERENCE ON APPLIED SCIENCES 2015 (ICAS2015), Book Series: IOP Conference Series-Materials Science and Engineering, Volume: 106, Article Number: 012012, International Conference on Applied Sciences (ICAS), JUN 03-05, 2015, Military Econ Acad Wuhan, Wuhan, PEOPLES R CHINA, ISSN: 1757-8981, Published: 2016;
269. Popa, R., Bob, C., Lures, L. Steel Fibres Reinforced Concretes used for Road, MODERN TECHNOLOGIES FOR THE 3RD MILLENNIUM, Pages: 153-156, 15th National Technical-Scientific Conference on Modern Technologies for the 3rd Millennium, NOV 27-28, 2015, Oradea, ROMANIA, ISBN: 978-88-7587-724-8, Published: 2016;
270. Pop-Calimanu, I.M., Renken, F. A Comparison between Single-Phase and Two-Phase Hybrid Buck L Converter, 2016 12TH IEEE INTERNATIONAL SYMPOSIUM ON ELECTRONICS AND TELECOMMUNICATIONS (ISETC'16), Pages: 223-226, 12th IEEE International Symposium on Electronics and Telecommunications (ISETC), OCT 27-28, 2016, Timisoara, ROMANIA, ISBN: 978-1-5090-3748-3, Published: 2016;

271. Popescu, A., Frigura-Iliasa, F.M., Vatau, D., Frigura-Iliasa, M., Balcu, F. A SIMPLE METAL OXIDE MATERIAL FOR VARISTORS USED IN DOMESTIC SURGE PROTECTION EQUIPMENT, NANO, BIO AND GREEN - TECHNOLOGIES FOR A SUSTAINABLE FUTURE CONFERENCE PROCEEDINGS, SGEM 2016, VOL III, Book Series: International Multidisciplinary Scientific GeoConference-SGEM, Pages: 3-9, 16th International Multidisciplinary Scientific Geoconference (SGEM 2016), JUN 30-JUL 06, 2016, Albena, BULGARIA, ISSN: 1314-2704, ISBN: 978-619-7105-79-7, Published: 2016;
272. Popescu, D., Borza, I. Ensuring the Comfort in the Heated Space by Controlling the Temperature in the Heating Installation of a Non-residential Building, SMARTGREENS: PROCEEDINGS OF THE 5TH INTERNATIONAL CONFERENCE ON SMART CITIES AND GREEN ICT SYSTEMS, Pages: 462-467, 5th International Conference on Smart Cities and Green ICT Systems (SMARTGREENS), APR 23-25, 2016, Rome, ITALY, ISBN: 978-989-758-184-7, Published: 2016;
273. Popescu, D., Borza, I. Modelling and Simulation of the Temperature Control System in the Heating Installations from Nonresidential Buildings, SMARTGREENS: PROCEEDINGS OF THE 5TH INTERNATIONAL CONFERENCE ON SMART CITIES AND GREEN ICT SYSTEMS, Pages: 454-461, 5th International Conference on Smart Cities and Green ICT Systems (SMARTGREENS), APR 23-25, 2016, Rome, ITALY, ISBN: 978-989-758-184-7, Published: 2016;
274. Popescu, D.A., Hepuț, T., Putan, V. Optimisation of the Steel Plant Dust Recycling Process, PROCEEDINGS OF THE INTERNATIONAL CONFERENCE ON NUMERICAL ANALYSIS AND APPLIED MATHEMATICS 2015 (ICNAAM-2015), Book Series: AIP Conference Proceedings, Volume: 1738, Article Number: 080009, International Conference on Numerical Analysis and Applied Mathematics (ICNAAM), SEP 23-29, 2015, Rhodes, GREECE, ISSN: 0094-243X, ISBN: 978-0-7354-1392-4, Published: 2016;
275. Popescu, D.A., Vilceanu, L., Socalici, A. Analysis of the Optimization Possibilities to Recover the Powdery Wastes Containing Iron and Carbon, PROCEEDINGS OF THE INTERNATIONAL CONFERENCE ON NUMERICAL ANALYSIS AND APPLIED MATHEMATICS 2015 (ICNAAM-2015), Book Series: AIP Conference Proceedings, Volume: 1738, Article Number: 080008, International Conference on Numerical Analysis and Applied Mathematics (ICNAAM), SEP 23-29, 2015, Rhodes, GREECE, ISSN: 0094-243X, ISBN: 978-0-7354-1392-4, Published: 2016;
276. Popescu, F. A Performant State-of-Art Tool to Assess Cross-Border Impact of Industrial Activities. A Transboundary Air Pollution Case Study, 9TH INTERNATIONAL CONFERENCE INTERDISCIPLINARITY IN ENGINEERING, INTER-ENG 2015, Book Series: Procedia Technology, Volume: 22, Pages: 440-444, 9th International Conference on Interdisciplinarity in Engineering (INTER-ENG), OCT 08-09, 2015, Univ Tirgu Mure, Fac Engn, Tirgu Mures, ROMANIA, ISSN: 2212-0173, Published: 2016;
277. Popov, M., Dogariu, A., Grecea, D., Ungureanu, V., Georgescu, M. Steel Structure Apartment Extensions for Existing Large Prefabricated Panel Collective Dwellings, WORLD MULTIDISCIPLINARY CIVIL ENGINEERING-ARCHITECTURE-URBAN PLANNING SYMPOSIUM 2016, WMCAUS 2016, Book Series: Procedia Engineering, Volume: 161, Pages: 1076-1083, World Multidisciplinary Civil Engineering-Architecture-Urban Planning Symposium (WMCAUS), JUN 13-17, 2016, Prague, CZECH REPUBLIC, ISSN: 1877-7058, Published: 2016;
278. Popovici, A., Babaita, M., Papazian, P. Synthesis of Universal Space Vector Modulator for Matrix Converters, 2016 12TH IEEE INTERNATIONAL SYMPOSIUM ON ELECTRONICS AND TELECOMMUNICATIONS (ISETC'16), Pages: 211-214, 12th IEEE International Symposium on Electronics and Telecommunications (ISETC), OCT 27-28, 2016, Timisoara, ROMANIA, ISBN: 978-1-5090-3748-3, Published: 2016;
279. Precup, R.E., David, R.C., Petriu, E.M., Szedlak-Stinean, A.I., Bojan-Dragos, C.A. Grey Wolf Optimizer-Based Approach to the Tuning of PI-Fuzzy Controllers with a Reduced Process Parametric Sensitivity, IFAC PAPERSONLINE, Volume: 49, Issue: 5, Pages: 55-60, 4th IFAC Conference on Intelligent Control and Automation Sciences (ICONS), JUN 01-03, 2016, Reims, FRANCE, ISSN: 2405-8963, Published: 2016;
280. Precup, R.E., David, R.C., Radac, M.B., Voisan, E.I., Petriu, E.M. Experiment-Based Comparison of Nature-Inspired Algorithms for Optimal Tuning of PI-Fuzzy Controlled Nonlinear DC Servo Systems, 2016 INTERNATIONAL SYMPOSIUM ON POWER ELECTRONICS, ELECTRICAL DRIVES, AUTOMATION AND MOTION (SPEEDAM), Pages: 1261-1266, International Symposium on Power Electronics, Electrical Drives, Automation and Motion (SPEEDAM), JUN 22-24, 2016, Capri, ITALY, ISBN: 978-1-5090-2067-6, Published: 2016;
281. Precup, R.E., Radac, M.B., Petriu, E.M., Roman, R.C., Teban, T.A., Szedlak-Stinean, A.I. Evolving Fuzzy Models for the Position Control of Twin Rotor Aerodynamic Systems, 2016 IEEE 14TH INTERNATIONAL CONFERENCE ON INDUSTRIAL INFORMATICS (INDIN), Book Series: IEEE International Conference on Industrial Informatics INDIN, Pages: 237-242, 14th IEEE International Conference on Industrial Informatics (INDIN), JUL 19-21, 2016, Poitiers, FRANCE, ISSN: 1935-4576, ISBN: 978-1-5090-2870-2, Published: 2016;

282. Precup, R.E., Teban, T.A., de Oliveira, T.E.A., Petriu, E.M. Evolving Fuzzy Models for Myoelectric-based Control of a Prosthetic Hand, 2016 IEEE INTERNATIONAL CONFERENCE ON FUZZY SYSTEMS (FUZZ-IEEE) Book Series: IEEE International Fuzzy Systems Conference Proceedings Pages: 72-77, IEEE International Conference on Fuzzy Systems (FUZZ-IEEE), JUL 24-29, 2016, Vancouver, CANADA, ISSN: 1544-5615, ISBN: 978-1-5090-0625-0, Published: 2016;
283. Pribac, V., Todea, C., Duma, V.F. Low-Level Laser Therapy (LLT) for periodontal pockets. A review, HIGH-END MEDICINE BASED ON LASER AND BIOTECHNOLOGIES, Book Series: Proceedings of SPIE, Volume: 9670, Article Number: 96700K, 5th Congress of the World-Federation-for-Laser-Dentistry / 6th International Conference on Lasers in Medicine, MAY 07-09, 2015, Bucharest, ROMANIA, ISSN: 0277-786X, ISBN: 978-1-62841-893-4, Published: 2016;
284. Prostean, G., Vasar, C., Prostean, O., Vartosu, A. Risk analysis for renewable energy projects due to constraints arising, INTERNATIONAL CONFERENCE ON APPLIED SCIENCES 2015 (ICAS2015), Book Series: IOP Conference Series-Materials Science and Engineering, Volume: 106, Article Number: 012017, International Conference on Applied Sciences (ICAS), JUN 03-05, 2015, Military Econ Acad Wuhan, Wuhan, PEOPLES R CHINA, ISSN: 1757-8981, Published: 2016;
285. Pugna, A., Miclea, S., Negrea, R., Potra, S. Small business owners undertaking organized marketing activities: out of need or available resources?, PROMOTING BUSINESS ANALYTICS AND QUANTITATIVE MANAGEMENT OF TECHNOLOGY: 4TH INTERNATIONAL CONFERENCE ON INFORMATION TECHNOLOGY AND QUANTITATIVE MANAGEMENT (ITQM 2016), Book Series: Procedia Computer Science, Volume: 91, Pages: 306-313, 4th International Conference on Information Technology and Quantitative Management (ITQM) - Promoting Business Analytics and Quantitative Management of Technology, AUG 16-18, 2016, Asan, SOUTH KOREA, ISSN: 1877-0509, Published: 2016;
286. Pugna, A., Negrea, R., Miclea, S. Using Six Sigma Methodology to Improve the Assembly Process in an Automotive Company, 13TH INTERNATIONAL SYMPOSIUM IN MANAGEMENT: MANAGEMENT DURING AND AFTER THE ECONOMIC CRISIS, Book Series: Procedia Social and Behavioral Sciences, Volume: 221, Pages: 308-316, 13th International Symposium in Management - Management During and after the Economic Crisis (SIM), OCT 09-10, 2015, Timisoara, ROMANIA, ISSN: 1877-0428, Published: 2016;
287. Pugna, A., Potra, S., Negrea, R., Miclea, S., Mocan, M. A Refined Quality Attribute Classification Model for New Product and Service Strategic Design, PROMOTING BUSINESS ANALYTICS AND QUANTITATIVE MANAGEMENT OF TECHNOLOGY: 4TH INTERNATIONAL CONFERENCE ON INFORMATION TECHNOLOGY AND QUANTITATIVE MANAGEMENT (ITQM 2016), Book Series: Procedia Computer Science, Volume: 91, Pages: 296-305, 4th International Conference on Information Technology and Quantitative Management (ITQM) - Promoting Business Analytics and Quantitative Management of Technology, AUG 16-18, 2016, Asan, SOUTH KOREA, ISSN: 1877-0509, Published: 2016;
288. Putan, V., Putan, A., Josan, A., Vilceanu, L. Researches concerning influence of magnesium, aluminum and titanium lime on steel desulfurization, INTERNATIONAL CONFERENCE ON APPLIED SCIENCES 2015 (ICAS2015), Book Series: IOP Conference Series-Materials Science and Engineering, Volume: 106, Article Number: 012033, International Conference on Applied Sciences (ICAS), JUN 03-05, 2015, Military Econ Acad Wuhan, Wuhan, PEOPLES R CHINA, ISSN: 1757-8981, Published: 2016;
289. Racolta, A., Milincu, C., Giurea, D. THE ANALYSIS OF PET BOTTLE REUSE AS A ROOF THERMAL INSULATION COMPONENT, NANO, BIO AND GREEN - TECHNOLOGIES FOR A SUSTAINABLE FUTURE CONFERENCE PROCEEDINGS, SGEM 2016, VOL II, Book Series: International Multidisciplinary Scientific GeoConference-SGEM, Pages: 731-738, 16th International Multidisciplinary Scientific Geoconference (SGEM 2016), JUN 30-JUL 06, 2016, Albena, BULGARIA, ISSN: 1314-2704, ISBN: 978-619-7105-69-8, Published: 2016;
290. Radac, M.B., Precup, R.E. Improving Model Reference Control Performance Using Model-Free VRFT and Q-Learning, 2016 20TH INTERNATIONAL CONFERENCE ON SYSTEM THEORY, CONTROL AND COMPUTING (ICSTCC), Book Series: International Conference on System Theory Control and Computing, Pages: 7-13, 20th International Conference on System Theory, Control and Computing (ICSTCC), OCT 13-15, 2016, Sinaia, ROMANIA, ISSN: 2372-1618, ISBN: 978-1-5090-2720-0, Published: 2016;
291. Radac, M.B., Precup, R.E., Roman, R.C. Data-Driven Virtual Reference Feedback Tuning and Reinforcement Q-learning for Model-Free Position Control of an Aerodynamic System, 2016 24TH MEDITERRANEAN CONFERENCE ON CONTROL AND AUTOMATION (MED), Book Series: Mediterranean Conference on Control and Automation, Pages: 1126-1132, 24th Mediterranean Conference on Control and Automation (MED), JUN 21-24, 2016, Athens, GREECE, ISSN: 2325-369X, ISBN: 978-1-4673-8345-5, Published: 2016;

292. Raduca, E., Ungureanu-Anghel, D., Nistor, L., Hatiegan, C., Draghici, S., Chioncel, C., Spunei, E., Lolea, R. Web server with ATMEGA 2560 microcontroller, INTERNATIONAL CONFERENCE ON APPLIED SCIENCES 2015 (ICAS2015), Book Series: IOP Conference Series-Materials Science and Engineering, Volume: 106, Article Number: UNSP 012018, International Conference on Applied Sciences (ICAS), JUN 03-05, 2015, Military Econ Acad Wuhan, Wuhan, PEOPLES R CHINA, ISSN: 1757-8981, Published: 2016;
293. Ratiu, S., Alexa, V., Kiss, I. Particular bi-fuel application of spark ignition engines, INTERNATIONAL CONFERENCE ON APPLIED SCIENCES 2015 (ICAS2015), Book Series: IOP Conference Series-Materials Science and Engineering, Volume: 106, Article Number: 012038, International Conference on Applied Sciences (ICAS), JUN 03-05, 2015, Military Econ Acad Wuhan, Wuhan, PEOPLES R CHINA, ISSN: 1757-8981, Published: 2016;
294. Renken, F., Schuermann, U., Chen, Q.Y., Pop-Calimanu, I.M. Novel Hybrid Buck L Converter for Wide Conversion Ratios, 2016 IEEE INTERNATIONAL POWER ELECTRONICS AND MOTION CONTROL CONFERENCE (PEMC), Book Series: IEEE International Power Electronics and Motion Control Conference IPEMC, Pages: 158-167, 17th IEEE International Power Electronics and Motion Control Conference (PEMC), SEP 25-28, 2016, Varna, BULGARIA, ISBN: 978-1-5090-1798-0, Published: 2016;
295. Rennung, F., Luminosu, C.T., Draghici, A. Service Provision in the Framework of Industry 4.0, 13TH INTERNATIONAL SYMPOSIUM IN MANAGEMENT: MANAGEMENT DURING AND AFTER THE ECONOMIC CRISIS, Book Series: Procedia Social and Behavioral Sciences, Volume: 221, Pages: 372-377, 13th International Symposium in Management - Management During and after the Economic Crisis (SIM), OCT 09-10, 2015, Timisoara, ROMANIA, ISSN: 1877-0428, Published: 2016;
296. Rigatos, G., Sinao, P., Selisteanu, D., Precup, R. An H-infinity Approach to Optimal Control of Oxygen and Carbon Dioxide Contents in Blood, Proceedings of the International Conference of Computational Methods in Sciences and Engineering 2016 (ICCMSE-2016), Book Series: AIP Conference Proceedings, Volume: 1790, Article Number: UNSP 060005, International Conference of Computational Methods in Sciences and Engineering (ICCMSE), MAR 17-20, 2016, Athens, GREECE, ISSN: 0094-243X, ISBN: 978-0-7354-1454-9, Published: 2016;
297. Rimescu, C., Musuroi, S., Frigura-Iliasa, F.M., Andea, P. Technical Solution for a Command and Control Interface on a Small Residential Heating, 2016 INTERNATIONAL CONFERENCE ON INFORMATION AND DIGITAL TECHNOLOGIES (IDT), Pages: 234-240, International Conference on Information and Digital Technologies (IDT), JUL 05-07, 2016, Rzeszow, POLAND, ISBN: 978-1-4673-8860-3, Published: 2016;
298. Rob, R., Panoiu, C., Panoiu, M. Study regarding the non-sinusoidal regime imposed by nonlinear loads, INTERNATIONAL CONFERENCE ON APPLIED SCIENCES 2015 (ICAS2015), Book Series: IOP Conference Series-Materials Science and Engineering, Volume: 106, Article Number: 012023, International Conference on Applied Sciences (ICAS), JUN 03-05, 2015, Military Econ Acad Wuhan, Wuhan, PEOPLES R CHINA, ISSN: 1757-8981, Published: 2016;
299. Rob, R., Tirian, G.O., Panoiu, C. Intelligent Acquisition System Used in Mechanical Laboratory, 20TH INTERNATIONAL CONFERENCE ON CIRCUITS, SYSTEMS, COMMUNICATIONS AND COMPUTERS (CSCC 2016), Book Series: MATEC Web of Conferences, Volume: 76, Article Number: UNSP 05007, 20th International Conference on Circuits, Systems, Communications and Computers (CSCC), JUL 14-17, 2016, Corfu, GREECE, ISSN: 2261-236X, Published: 2016;
300. Rosu, V., Marcu, M. Real Time Adaptive Video Streaming, 2016 IEEE 12TH INTERNATIONAL CONFERENCE ON INTELLIGENT COMPUTER COMMUNICATION AND PROCESSING (ICCP), Book Series: IEEE International Conference on Intelligent Computer Communication and Processing ICCP, Pages: 239-246, 12th IEEE International Conference on Intelligent Computer Communication and Processing (ICCP), SEP 08-10, 2016, Cluj Napoca, ROMANIA, ISSN: 2065-9946, ISBN: 978-1-5090-3898-5, Published: 2016;
301. Rus, S., Mocan, M., Ardelean, B.O., Ivascu, L., Cioca, L.I. Conceptualization and examination of success factors in the banking system, 3RD GLOBAL CONFERENCE ON BUSINESS, ECONOMICS, MANAGEMENT AND TOURISM, Book Series: Procedia Economics and Finance, Volume: 39, Pages: 679-684, 3rd Global Conference on Business, Economics, Management and Tourism (BEMTUR), NOV 26-28, 2015, Rome, ITALY, ISSN: 2212-5671, Published: 2016;
302. Rus, S., Mocan, M., Draghici, A., Ivascu, L. Crisis Effects on Banking System Management in Romania, VISION 2020: INNOVATION MANAGEMENT, DEVELOPMENT SUSTAINABILITY, AND COMPETITIVE ECONOMIC GROWTH, 2016, VOLS I - VII, Pages: 1910-1916, 28th International Business-Information-Management-Association Conference, NOV 09-10, 2016, Seville, SPAIN, ISBN: 978-0-9860419-8-3, Published: 2016;

303. Rus, S., Pujol, F.X., Mocan, M. Role of the Banking System in the National Economic Stability, INNOVATION MANAGEMENT AND EDUCATION EXCELLENCE VISION 2020: FROM REGIONAL DEVELOPMENT SUSTAINABILITY TO GLOBAL ECONOMIC GROWTH, VOLS I – VI, Pages: 518–526, 27th International Business Information Management Association Conference, MAY 04–05, 2016, Milan, ITALY, ISBN: 978-0-9860419-6-9, Published: 2016;
304. Salcianu, C.L., Bordeasu, I., Mitelea, I., Craciunescu, C.M. GAS NITRIDING AND CAVITATION EROSION RESISTANCE OF X5CrNi18-10 STAINLESS STEEL, METAL 2016: 25TH ANNIVERSARY INTERNATIONAL CONFERENCE ON METALLURGY AND MATERIALS, Pages: 843–848, 25th Anniversary International Conference on Metallurgy and Materials (METAL), MAY 25–27, 2016, Brno, CZECH REPUBLIC, ISBN: 978-80-87294-67-3, Published: 2016;
305. Sandru, F.D., Nanu, S., Silea, I., Miclea, R.C. Kalman and Butterworth filtering for GNSS/INS data, 2016 12TH IEEE INTERNATIONAL SYMPOSIUM ON ELECTRONICS AND TELECOMMUNICATIONS (ISETC'16), Pages: 257–260, 12th IEEE International Symposium on Electronics and Telecommunications (ISETC), OCT 27–28, 2016, Timisoara, ROMANIA, ISBN: 978-1-5090-3748-3, Published: 2016;
306. Sandru, L., Dolga, V., Moldovan, C., Savu, D. Mechatronic demonstrator for testing sensors to be used in mobile robotics functioning on the inverted pendulum concept, 7TH INTERNATIONAL CONFERENCE ON ADVANCED CONCEPTS IN MECHANICAL ENGINEERING, Book Series: IOP Conference Series–Materials Science and Engineering, Volume: 147, Article Number: UNSP 012065, 7th International Conference on Advanced Concepts in Mechanical Engineering (ACME), JUN 09–10, 2016, Iasi, ROMANIA, ISSN: 1757-8981, Published: 2016;
307. Sangwongwanich, A., Mathe, L., Teodorescu, R., Lascu, C., Harnefors, L. Two-Dimension Sorting and Selection Algorithm featuring Thermal Balancing Control for Modular Multilevel Converters, 2016 18TH EUROPEAN CONFERENCE ON POWER ELECTRONICS AND APPLICATIONS (EPE'16 ECCE EUROPE), Book Series: European Conference on Power Electronics and Applications, 18th European Conference on Power Electronics and Applications (EPE), SEP 05–09, 2016, GERMANY, ISSN: 2325-0313, Published: 2016;
308. Sarb, D., Bogdan, R. Wireless Motor Control in Automotive Industry, 2016 24TH TELECOMMUNICATIONS FORUM (TELFOR), Pages: 332–335, 24th Telecommunications Forum (TELFOR), NOV 22–23, 2016, Belgrade, SERBIA, ISBN: 978-1-5090-4086-5, Published: 2016;
309. Schwalie, A., Feier, A., Hernea, S., Bancila, R. Four historical steel bridges over the Mures River, BRIDGES IN DANUBE BASIN 2016 – NEW TRENDS IN BRIDGE ENGINEERING AND EFFICIENT SOLUTION FOR LARGE AND MEDIUM SPAN BRIDGES, Book Series: Procedia Engineering, Volume: 156, Pages: 419–426, 9th International Conference on Bridges in Danube Basin, SEP 30–OCT 01, 2016, Zilina, SLOVAKIA, ISSN: 1877-7058, Published: 2016;
310. Schwalie, A., Petzek, E., Feier, A., Bancila, R. Historical steel bridges in the Tisa basin; present technical condition, functionality and sustainable rehabilitation, BRIDGES IN DANUBE BASIN 2016 – NEW TRENDS IN BRIDGE ENGINEERING AND EFFICIENT SOLUTION FOR LARGE AND MEDIUM SPAN BRIDGES, Book Series: Procedia Engineering, Volume: 156, Pages: 427–434, 9th International Conference on Bridges in Danube Basin, SEP 30–OCT 01, 2016, Zilina, SLOVAKIA, ISSN: 1877-7058, Published: 2016;
311. Schwalie, A., Petzek, E., Feier, A., Bancila, R. Integration of the rehabilitated old steel bridge in Lipova on the Mures – river in the Danube basin in the historical area of the town, BRIDGES IN DANUBE BASIN 2016 – NEW TRENDS IN BRIDGE ENGINEERING AND EFFICIENT SOLUTION FOR LARGE AND MEDIUM SPAN BRIDGES, Book Series: Procedia Engineering, Volume: 156, Pages: 435–442, 9th International Conference on Bridges in Danube Basin, SEP 30–OCT 01, 2016, Zilina, SLOVAKIA, ISSN: 1877-7058, Published: 2016;
312. Scurt, A.A., Ghemis, M.T., Bob, C. THE SUSTAINABILITY INDEX FOR STRENGTHENING OF REINFORCED CONCRETE FRAMED FILLED WITH BRICK MASONRY STRUCTURES, ENERGY AND CLEAN TECHNOLOGIES CONFERENCE PROCEEDINGS, SGEM 2016, VOL I, Book Series: International Multidisciplinary Scientific GeoConference–SGEM, Pages: 761–768, 16th International Multidisciplinary Scientific Geoconference (SGEM 2016), JUN 30–JUL 06, 2016, Albena, BULGARIA, ISSN: 1314-2704, ISBN: 978-619-7105-63-6, Published: 2016;
313. Scurt, A.A., Ghemis, M.T., Bob, C. The Sustainability Solution for Strengthening of RC Framed Structures, MODERN TECHNOLOGIES FOR THE 3RD MILLENNIUM, Pages: 163–167, 15th National Technical–Scientific Conference on Modern Technologies for the 3rd Millennium, NOV 27–28, 2015, Oradea, ROMANIA, ISBN: 978-88-7587-724-8, Published: 2016;
314. Sebarchievici, C., Sarbu, I. PERFORMANCE EVALUATION OF AN AIR-TO-WATER HEAT PUMP SYSTEM IN DOMESTIC HOT WATER OPERATION FOR A PASSIVE HOUSE, ENERGY AND CLEAN TECHNOLOGIES CONFERENCE PROCEEDINGS, SGEM 2016, VOL I, Book Series: International Multidisciplinary Scientific GeoConference–SGEM, Pages: 519–524, 16th International Multidisciplinary Scientific Geoconference (SGEM 2016), JUN 30–JUL 06, 2016, Albena, BULGARIA, ISSN: 1314-2704, ISBN: 978-619-7105-63-6, Published: 2016;

315. Sebu, M.L., Ciocarlie, H. Optimizing Business Processes by Learning from Monitoring Results, 2016 IEEE 11TH INTERNATIONAL SYMPOSIUM ON APPLIED COMPUTATIONAL INTELLIGENCE AND INFORMATICS (SACI), Pages: 43-49, 11th IEEE International Symposium on Applied Computational Intelligence and Informatics (SACI), MAY 12-14, 2016, Timisoara, ROMANIA, ISBN: 978-1-5090-2380-6, Published: 2016;
316. Sebu, M.L., Ciocarlie, H. Similarity of Business Process Models in a Modular Design, 2016 IEEE 11TH INTERNATIONAL SYMPOSIUM ON APPLIED COMPUTATIONAL INTELLIGENCE AND INFORMATICS (SACI), Pages: 31-36, 11th IEEE International Symposium on Applied Computational Intelligence and Informatics (SACI), MAY 12-14, 2016, Timisoara, ROMANIA, ISBN: 978-1-5090-2380-6, Published: 2016;
317. Senila, M., Sigauan, A., Marginean, I., Dinu, F. NUMERICAL MODELS FOR STEEL AND COMPOSITE ECCENTRICALLY BRACED FRAMES UNDER SEISMIC ACTIONS, IRF2016: 5TH INTERNATIONAL CONFERENCE INTEGRITY-RELIABILITY-FAILURE, Pages: 1453-1454, 5th International Conference on Integrity-Reliability-Failure (IRF), JUL 24-28, 2016, Univ Porto, Fac Engn, Porto, PORTUGAL, ISBN: 978-989-98832-5-3, Published: 2016;
318. Serban, A., Crisan-Vida, M., Mada, L., Stoicu-Tivadar, L. User Interface Design in Medical Distributed Web Applications, HEALTH INFORMATICS MEETS EHEALTH, Book Series: Studies in Health Technology and Informatics, Volume: 223, Pages: 223-229, 10th eHealth Conference on Predictive Modeling in Healthcare - From Prediction to Prevention, MAY 24-25, 2016, Vienna, AUSTRIA, ISSN: 0926-9630, ISBN: 978-1-61499-645-3; 978-1-61499-644-6, Published: 2016;
319. Sfirat, A., Gontean, A. Thermoelectric Harvesting System Control Algorithms Analysis, 2016 12TH IEEE INTERNATIONAL SYMPOSIUM ON ELECTRONICS AND TELECOMMUNICATIONS (ISETC'16), 12th IEEE International Symposium on Electronics and Telecommunications (ISETC), OCT 27-28, 2016, Timisoara, ROMANIA, ISBN: 978-1-5090-3748-3, Published: 2016;
320. Sicoe, O., Popa, M. Generation of Floating Point 2D Scaling Operators for FPGA, 2016 IEEE 11TH INTERNATIONAL SYMPOSIUM ON APPLIED COMPUTATIONAL INTELLIGENCE AND INFORMATICS (SACI), Pages: 131-136, 11th IEEE International Symposium on Applied Computational Intelligence and Informatics (SACI), MAY 12-14, 2016, Timisoara, ROMANIA, ISBN: 978-1-5090-2380-6, Published: 2016;
321. Silaghi, A.M., De Sabata, A., Alexa, F., Buta, A., Baderca, S. Measurement of Radiated Immunity in the Automotive industry: Key concepts, 2016 12TH IEEE INTERNATIONAL SYMPOSIUM ON ELECTRONICS AND TELECOMMUNICATIONS (ISETC'16), Pages: 25-28, 12th IEEE International Symposium on Electronics and Telecommunications (ISETC), OCT 27-28, 2016, Timisoara, ROMANIA, ISBN: 978-1-5090-3748-3, Published: 2016;
322. Silaghi, A.M., Tolan, E., De Sabata, A., Buta, A. Measurement of Radiated Emissions from an automotive cluster, 2016 12TH IEEE INTERNATIONAL SYMPOSIUM ON ELECTRONICS AND TELECOMMUNICATIONS (ISETC'16), Pages: 21-24, 12th IEEE International Symposium on Electronics and Telecommunications (ISETC), OCT 27-28, 2016, Timisoara, ROMANIA, ISBN: 978-1-5090-3748-3, Published: 2016;
323. Silea, I., Miclea, R.C., Alexa, F. System for Visibility Distance Estimation in Fog Conditions based on Light Sources and Visual Acuity, PROCEEDING OF 2016 IEEE INTERNATIONAL CONFERENCE ON AUTOMATION, QUALITY AND TESTING, ROBOTICS (AQTR), Book Series: IEEE International Conference on Automation Quality and Testing Robotics, Pages: 233-238, IEEE International Conference on Automation, Quality and Testing, Robotics (AQTR), MAY 19-21, 2016, Cluj Napoca, ROMANIA, ISSN: 1844-7872, ISBN: 978-1-4673-8690-6, Published: 2016;
324. Sinescu, C., Duma, V.F., Canjau, S., Dobre, G., Demian, D., Cernat, R., Negrutiu, M.L., Todea, C., Topala, F.I., Hutiu, G., Bradu, A., Podoleanu, A.G. Dentistry investigations of teeth and dental prostheses using OCT, BIOPHOTONICS: PHOTONIC SOLUTIONS FOR BETTER HEALTH CARE V, Book Series: Proceedings of SPIE, Volume: 9887, Article Number: UNSP 98870B, Conference on Biophotonics - Photonic Solutions for Better Health Care V, APR 04-07, 2016, Brussels, BELGIUM, ISSN: 0277-786X, ISBN: 978-1-5106-0132-1, Published: 2016;
325. Socalici, A., Pascu, L., Ardelean, E., Popa, E. Researches on obtaining composite materials to be used in manufacturing brake pads, INTERNATIONAL CONFERENCE ON APPLIED SCIENCES 2015 (ICAS2015), Book Series: IOP Conference Series-Materials Science and Engineering, Volume: 106, Article Number: 012015, International Conference on Applied Sciences (ICAS), JUN 03-05, 2015, Military Econ Acad Wuhan, Wuhan, PEOPLES R CHINA, ISSN: 1757-8981, Published: 2016;
326. Solomon, C., Groza, B. LiMon - Lightweight Authentication for Tire Pressure Monitoring Sensors, Security of Industrial Control Systems and Cyber Physical Systems, Book Series: Lecture Notes in Computer Science, Volume: 9588, Pages: 95-111, 1st Workshop on Cybersecurity of Industrial Control Systems (CyberICS) / 1st Workshop on the Security of Cyber-Physical Systems (WOS-CPS), SEP 21-22, 2015, Vienna, AUSTRIA, ISSN: 0302-9743, ISBN: 978-3-319-40385-4; 978-3-319-40384-7, Published: 2016;

327. Sora, I., Todinca, D. Using Fuzzy Rules for Identifying Key Classes in Software Systems, 2016 IEEE 11TH INTERNATIONAL SYMPOSIUM ON APPLIED COMPUTATIONAL INTELLIGENCE AND INFORMATICS (SACI), Pages: 317-322, 11th IEEE International Symposium on Applied Computational Intelligence and Informatics (SACI), MAY 12-14, 2016, Timisoara, ROMANIA, ISBN: 978-1-5090-2380-6, Published: 2016;
328. Sorandaru, C., Musuroi, S., Ancuti, M.C., Erdodi, G.M., Petrescu, D.I. Equivalent Power for a Wind Power System, 2016 IEEE 11TH INTERNATIONAL SYMPOSIUM ON APPLIED COMPUTATIONAL INTELLIGENCE AND INFORMATICS (SACI), Pages: 225-228, 11th IEEE International Symposium on Applied Computational Intelligence and Informatics (SACI), MAY 12-14, 2016, Timisoara, ROMANIA, ISBN: 978-1-5090-2380-6, Published: 2016;
329. Stan, A.T., Cojocariu, A.C., Antal, A.A., Topala, F., Sinescu, C., Negrutiu, M.L., Duma, V.F., Podoleanu, A.G. Marginal integrity evaluation of dental composite using optical coherence tomography, HIGH-END MEDICINE BASED ON LASER AND BIOTECHNOLOGIES, Book Series: Proceedings of SPIE, Volume: 9670, Article Number: 967012, 5th Congress of the World-Federation-for-Laser-Dentistry / 6th International Conference on Lasers in Medicine, MAY 07-09, 2015, Bucharest, ROMANIA, ISSN: 0277-786X, ISBN: 978-1-62841-893-4, Published: 2016;
330. Stancovici, A., Micea, M.V., Cretu, V. Cooperative Positioning System for Indoor Surveillance Applications, 2016 INTERNATIONAL CONFERENCE ON INDOOR POSITIONING AND INDOOR NAVIGATION (IPIN), Book Series: International Conference on Indoor Positioning and Indoor Navigation, International Conference on Indoor Positioning and Indoor Navigation (IPIN), OCT 04-07, 2016, Madrid, SPAIN, ISSN: 2162-7347, ISBN: 978-1-5090-2425-4, Published: 2016;
331. Stanescu, T., Savu, D., Dolga, V. Rotation Angle Determination of a Rectangular Object Using an Infrared Sensorial System, ADVANCES IN ROBOT DESIGN AND INTELLIGENT CONTROL, Book Series: Advances in Intelligent Systems and Computing, Volume: 371, Pages: 213-221, 24th International Conference on Robotics in Alpe-Adria-Danube Region (RAAD), MAY 27-29, 2015, Bucharest, ROMANIA, ISSN: 2194-5357, ISBN: 978-3-319-21290-6; 978-3-319-21289-0, Published: 2016;
332. Stangaciu, C.S., Stangaciu, V., Micea, M.V., Stoica, A., Cretu, V.I. TEEARTS: Time and Energy Efficiency Analysis for Real Time Systems Framework, 2016 IEEE 11TH INTERNATIONAL SYMPOSIUM ON APPLIED COMPUTATIONAL INTELLIGENCE AND INFORMATICS (SACI), Pages: 151-155, 11th IEEE International Symposium on Applied Computational Intelligence and Informatics (SACI), MAY 12-14, 2016, Timisoara, ROMANIA, ISBN: 978-1-5090-2380-6, Published: 2016;
333. Stoica, E.T., Marcauteanu, C., Sinescu, C., Negrutiu, M.L., Topala, F., Duma, V.F., Bradu, A., Podoleanu, A.G. All ceramic "table tops" analyzed using swept source optical coherence tomography, HIGH-END MEDICINE BASED ON LASER AND BIOTECHNOLOGIES, Book Series: Proceedings of SPIE, Volume: 9670, Article Number: UNSP 967011, 5th Congress of the World-Federation-for-Laser-Dentistry / 6th International Conference on Lasers in Medicine, MAY 07-09, 2015, Bucharest, ROMANIA, ISSN: 0277-786X, ISBN: 978-1-62841-893-4, Published: 2016;
334. Stolojescu-Crisan, C., Botoca, C. SONAR Images Restoration in the Wavelets Domain, 2016 12TH IEEE INTERNATIONAL SYMPOSIUM ON ELECTRONICS AND TELECOMMUNICATIONS (ISETC'16), Pages: 265-268, 12th IEEE International Symposium on Electronics and Telecommunications (ISETC), OCT 27-28, 2016, Timisoara, ROMANIA, ISBN: 978-1-5090-3748-3, Published: 2016;
335. Szabo, R., Gontean, A. Creation of a Fight Game in Borland Pascal with the Possibility to be Ported on an FPGA, 2016 IEEE 22ND INTERNATIONAL SYMPOSIUM FOR DESIGN AND TECHNOLOGY AND ELECTRONIC PACKAGING (SIITME) Pages: 122-125, 22nd IEEE International Symposium for Design and Technology in Electronic Packaging (SIITME), OCT 20-23, 2016, Oradea, ROMANIA, ISBN: 978-1-5090-4446-7, Published: 2016;
336. Szabo, R., Gontean, A. Lynxmotion AL5 Type Robotic Arm Control with Color Detection on FPGA Running Linux OS, 2016 24TH TELECOMMUNICATIONS FORUM (TELFOR), Pages: 818-821, 24th Telecommunications Forum (TELFOR), NOV 22-23, 2016, Belgrade, SERBIA, ISBN: 978-1-5090-4086-5, Published: 2016;
337. Szabo, R., Gontean, A. Mouse and Display Driver on a Single Microchip Tested on FPGA and Built for an ASIC, 2016 IEEE 22ND INTERNATIONAL SYMPOSIUM FOR DESIGN AND TECHNOLOGY AND ELECTRONIC PACKAGING (SIITME) Pages: 118-121, 22nd IEEE International Symposium for Design and Technology in Electronic Packaging (SIITME), OCT 20-23, 2016, Oradea, ROMANIA, ISBN: 978-1-5090-4446-7, Published: 2016;
338. Szabo, R., Gontean, A. Robotic Arm Joint Recognition in Space Using a Neural Network Trained with Pattern Matching in LabWindows/CVI with Vision Development Module, 2016 12TH IEEE INTERNATIONAL SYMPOSIUM ON ELECTRONICS AND TELECOMMUNICATIONS (ISETC'16), Pages: 227-230, 12th IEEE International Symposium on Electronics and Telecommunications (ISETC), OCT 27-28, 2016, Timisoara, ROMANIA, ISBN: 978-1-5090-3748-3, Published: 2016;

339. Szedlak-Stinean, A.I., Precup, R.E., Preitl, S., Petriu, E.M., Bojan-Dragos, C.A. State Feedback Control Solutions for a Mechatronics System with Variable Moment of Inertia, ICINCO: PROCEEDINGS OF THE 13TH INTERNATIONAL CONFERENCE ON INFORMATICS IN CONTROL, AUTOMATION AND ROBOTICS, VOL 2, Pages: 458-465, 13th International Conference on Informatics in Control, Automation and Robotics (ICINCO), JUL 29-31, 2016, Lisbon, PORTUGAL, ISBN: 978-989-758-198-4, Published: 2016;
340. Szedlak-Stinean, A.I., Preitl, S., Precup, R.E., Bojan-Dragos, C.A. An Adaptable Feedback Control Solution for a Drive System with Variable Parameters, 2016 IEEE 11TH INTERNATIONAL SYMPOSIUM ON APPLIED COMPUTATIONAL INTELLIGENCE AND INFORMATICS (SACI), Pages: 209-215, 11th IEEE International Symposium on Applied Computational Intelligence and Informatics (SACI), MAY 12-14, 2016, Timisoara, ROMANIA, ISBN: 978-1-5090-2380-6, Published: 2016;
341. Szeidert, I., Filip, I., Prostean, O. Issues regarding the modelling and simulation of hybrid micro grid systems, INTERNATIONAL CONFERENCE ON APPLIED SCIENCES 2015 (ICAS2015), Book Series: IOP Conference Series-Materials Science and Engineering, Volume: 106, Article Number: 012028, International Conference on Applied Sciences (ICAS), JUN 03-05, 2015, Military Econ Acad Wuhan, Wuhan, PEOPLES R CHINA, ISSN: 1757-8981, Published: 2016;
342. Szeidert, I., Filip, I., Prostean, O., Vasar, C. Laboratory Setup for Microgrid Study, INES 2016 20TH JUBILEE IEEE INTERNATIONAL CONFERENCE ON INTELLIGENT ENGINEERING SYSTEMS, Book Series: IEEE International Conference on Intelligent Engineering Systems, Pages: 289-292, 20th Jubilee IEEE International Conference on Intelligent Engineering Systems (INES), JUN 30-JUL 02, 2016, Budapest, HUNGARY, ISSN: 1562-5850, ISBN: 978-1-5090-1216-9, Published: 2016;
343. Szeidert, I., Filip, I., Vasar, C., Prostean, O. Computation of Electrical Generator Parameters Using Regression Functions, 2016 IEEE 11TH INTERNATIONAL SYMPOSIUM ON APPLIED COMPUTATIONAL INTELLIGENCE AND INFORMATICS (SACI), Pages: 89-92, 11th IEEE International Symposium on Applied Computational Intelligence and Informatics (SACI), MAY 12-14, 2016, Timisoara, ROMANIA, ISBN: 978-1-5090-2380-6, Published: 2016;
344. Tamas, M., Man, T.E., Pelea, G.N., Beilicci, R., Coccoceanu, A., Costescu, I.A. Study on Water Source Protection – Case Study of Lake Buhui – Anina City, Caras – Severin County, Romania, WORLD MULTIDISCIPLINARY CIVIL ENGINEERING-ARCHITECTURE-URBAN PLANNING SYMPOSIUM 2016, WMCAUS 2016, Book Series: Procedia Engineering, Volume: 161, Pages: 2203-2208, World Multidisciplinary Civil Engineering-Architecture-Urban Planning Symposium (WMCAUS), JUN 13-17, 2016, Prague, CZECH REPUBLIC, ISSN: 1877-7058, Published: 2016;
345. Tanasa, C., Fofiu, M., Stoian, D., Stoian, V., Dan, D. Air Tightness Measurements for an Energy Efficient Residential House Using the Blower Door Procedure, MODERN TECHNOLOGIES FOR THE 3RD MILLENNIUM, Pages: 169-174, 15th National Technical-Scientific Conference on Modern Technologies for the 3rd Millennium, NOV 27-28, 2015, Oradea, ROMANIA, ISBN: 978-88-7587-724-8, Published: 2016;
346. Tarfulea, N., Frigura-Iliasa, F.M., Vatau, D., Andea, P., Balcu, F., Macarie, A.C. A new Algorithm for the Design of Metal Oxide Varistor Surge Arresters, 2016 IEEE 16TH INTERNATIONAL CONFERENCE ON ENVIRONMENT AND ELECTRICAL ENGINEERING (EEEIC), IEEE 16th International Conference on Environment and Electrical Engineering (EEEIC), JUN 07-10, 2016, Florence, ITALY, ISBN: 978-1-5090-2320-2, Published: 2016;
347. Taucan, I.M., Tamasila, M., Negru-Strauti, G. Study on Management Styles and Managerial Power Types for a Large Organization, 13TH INTERNATIONAL SYMPOSIUM IN MANAGEMENT: MANAGEMENT DURING AND AFTER THE ECONOMIC CRISIS, Book Series: Procedia Social and Behavioral Sciences, Volume: 221, Pages: 66-75, 13th International Symposium in Management – Management During and after the Economic Crisis (SIM), OCT 09-10, 2015, Timisoara, ROMANIA, ISSN: 1877-0428, Published: 2016;
348. Teban, T.A., Precup, R.E., Voisan, E.I., de Oliveira, T.E.A., Petriu, E.M. Recurrent Dynamic Neural Network Model for Myoelectric-based Control of a Prosthetic Hand, 2016 ANNUAL IEEE SYSTEMS CONFERENCE (SYSCON), Pages: 117-122, 10th Annual IEEE International Systems Conference (SysCon), APR 18-21, 2016, Orlando, FL, ISBN: 978-1-4673-9519-9, Published: 2016;
349. Tesila, R., Rusu, G., Vilceanu, B., Alionescu, A. Targeting Displacements' Monitoring of Constructions through Mathematical Methods, PROCEEDINGS OF THE INTERNATIONAL CONFERENCE ON NUMERICAL ANALYSIS AND APPLIED MATHEMATICS 2015 (ICNAAM-2015), Book Series: AIP Conference Proceedings, Volume: 1738, Article Number: 350010, International Conference on Numerical Analysis and Applied Mathematics (ICNAAM), SEP 23-29, 2015, Rhodes, GREECE, ISSN: 0094-243X, ISBN: 978-0-7354-1392-4, Published: 2016;

350. Tihu, M.G., Telbis, D.G., Babau, C.N., Marcu, M. Energy Efficiency of Raw Sensor Data Collection on Mobile Devices, 2016 IEEE 11TH INTERNATIONAL SYMPOSIUM ON APPLIED COMPUTATIONAL INTELLIGENCE AND INFORMATICS (SACI), Pages: 371-375, 11th IEEE International Symposium on Applied Computational Intelligence and Informatics (SACI), MAY 12-14, 2016, Timisoara, ROMANIA, ISBN: 978-1-5090-2380-6, Published: 2016;
351. Tirian, G.O., Filip, I., Chioncel, C.P. Intelligent System for Continuous Steel Casting Based on Water Flow Control in the Secondary Cooling Stage, 2016 3RD INTERNATIONAL CONFERENCE ON INDUSTRIAL ENGINEERING AND APPLICATIONS (ICIEA 2016), Book Series: MATEC Web of Conferences, Volume: 68, Article Number: UNSP 10003, 3th International Conference on Industrial Engineering and Applications (ICIEA), APR 28-30, 2016, Hong Kong, PEOPLES R CHINA, ISSN: 2261-236X, Published: 2016;
352. Tisca, I.A., Istrat, N., Dumitrescu, C.D., Cornu, G. Issues concerning the road safety concept, 3RD GLOBAL CONFERENCE ON BUSINESS, ECONOMICS, MANAGEMENT AND TOURISM, Book Series: Procedia Economics and Finance, Volume: 39, Pages: 441-445, 3rd Global Conference on Business, Economics, Management and Tourism (BEMTUR), NOV 26-28, 2015, Rome, ITALY, ISSN: 2212-5671, Published: 2016;
353. Tisca, I.A., Istrat, N., Dumitrescu, C.D., Cornu, G. Management of sustainable development in ecotourism. Case Study Romania, 3RD GLOBAL CONFERENCE ON BUSINESS, ECONOMICS, MANAGEMENT AND TOURISM, Book Series: Procedia Economics and Finance, Volume: 39, Pages: 427-432, 3rd Global Conference on Business, Economics, Management and Tourism (BEMTUR), NOV 26-28, 2015, Rome, ITALY, ISSN: 2212-5671, Published: 2016;
354. Tiuc, D., Draghici, G. TRIZ Model Used for Complaint Management in the Automotive Product Development Process, 13TH INTERNATIONAL SYMPOSIUM IN MANAGEMENT: MANAGEMENT DURING AND AFTER THE ECONOMIC CRISIS, Book Series: Procedia Social and Behavioral Sciences, Volume: 221, Pages: 414-422, 13th International Symposium in Management - Management During and after the Economic Crisis (SIM), OCT 09-10, 2015, Timisoara, ROMANIA, ISSN: 1877-0428, Published: 2016;
355. Toader, D., Blaj, C., Vlad, V. Influence on the Magnetic Flux of the Iron Core of One-layer Power Cable, 2016 INTERNATIONAL SYMPOSIUM ON FUNDAMENTALS OF ELECTRICAL ENGINEERING (ISFEE), International Symposium on Fundamentals of Electrical Engineering (ISFEE), JUN 30-JUL 02, 2016, ROMANIA, ISBN: 978-1-4673-9575-5, Published: 2016;
356. Todorovici, L., Bogdan, R. Studying Thermal Behavior of Buildings and Vehicles by Means of a Mobile Thermographic System, 2016 24TH TELECOMMUNICATIONS FORUM (TELFOR), Pages: 830-833, 24th Telecommunications Forum (TELFOR), NOV 22-23, 2016, Belgrade, SERBIA, ISBN: 978-1-5090-4086-5, Published: 2016;
357. Topor, M. Real Time Wind Farm Emulation using SimWindFarm Toolbox, PROCEEDINGS OF THE INTERNATIONAL CONFERENCE ON NUMERICAL ANALYSIS AND APPLIED MATHEMATICS 2015 (ICNAAM-2015), Book Series: AIP Conference Proceedings, Volume: 1738, Article Number: 410003, International Conference on Numerical Analysis and Applied Mathematics (ICNAAM), SEP 23-29, 2015, Rhodes, GREECE, ISSN: 0094-243X, ISBN: 978-0-7354-1392-4, Published: 2016;
358. Totorean, A.F., Bernad, S.I., Susan-Resiga, R.F. The Influence of Stenosis Degrees and Graft Suture Position on Local Hemodynamics of Coronary Bypass, PROCEEDINGS OF THE INTERNATIONAL CONFERENCE ON NUMERICAL ANALYSIS AND APPLIED MATHEMATICS 2015 (ICNAAM-2015), Book Series: AIP Conference Proceedings, Volume: 1738, Article Number: 030029, International Conference on Numerical Analysis and Applied Mathematics (ICNAAM), SEP 23-29, 2015, Rhodes, GREECE, ISSN: 0094-243X, ISBN: 978-0-7354-1392-4, Published: 2016;
359. Turi, A., Mocan, M., Pujol, F.X. TEACHER-STUDENT PERCEPTION DIFFERENCES ON ETHICAL ISSUES IN HIGHER EDUCATION, PROCEEDINGS OF THE 13TH INTERNATIONAL CONFERENCE EFFICIENCY AND RESPONSIBILITY IN EDUCATION, Book Series: Efficiency and Responsibility in Education, Pages: 592-601, 13th International Conference Efficiency and Responsibility in Education (ERIE), JUN 02-03, 2016, Prague, CZECH REPUBLIC, ISSN: 2336-744X, ISBN: 978-80-213-2646-0, Published: 2016;
360. Tutelea, L.N., Muntean, N., Deaconu, S.I., Cuntan, C.D. Dual stator winding variable speed asynchronous generator: magnetic equivalent circuit with saturation, FEM analysis and experiments, INTERNATIONAL CONFERENCE ON APPLIED SCIENCES 2015 (ICAS2015), Book Series: IOP Conference Series-Materials Science and Engineering, Volume: 106, Article Number: 012029, International Conference on Applied Sciences (ICAS), JUN 03-05, 2015, Military Econ Acad Wuhan, Wuhan, PEOPLES R CHINA, ISSN: 1757-8981, Published: 2016;

361. Udrescu, L., Udrescu, M., Mihaicuta, S. A heavy-weight combo: obstructive sleep apnea - chronic obstructive pulmonary disease overlap syndrome, JOURNAL OF SLEEP RESEARCH, Meeting Abstract: P539, Volume: 25, Special Issue: SI, Pages: 260-261, 23rd Congress of the European-Sleep-Research-Society, SEP 13-16, 2016, Bologna, ITALY, ISSN: 0962-1105, eISSN: 1365-2869, Supplement: 1, Published: SEP 2016;
362. Urlan, S.D., Mitelea, I., Utu, I.D., Karancsi, O., Burca, M. PROCESS PARAMETERS AND THE STRUCTURE OF MAG PULSED DUPLEX STAINLESS STEEL WELDED JOINTS, METAL 2016: 25TH ANNIVERSARY INTERNATIONAL CONFERENCE ON METALLURGY AND MATERIALS, Pages: 873-878, 25th Anniversary International Conference on Metallurgy and Materials (METAL), MAY 25-27, 2016, Brno, CZECH REPUBLIC, ISBN: 978-80-87294-67-3, Published: 2016;
363. Vasar, C., Prostean, G., Szeidert, I. An Analysis of Diffuse Solar Radiation, INES 2016 20th Jubilee IEEE International Conference on Intelligent Engineering Systems, Book Series: IEEE International Conference on Intelligent Engineering Systems, Pages: 161-164, 20th Jubilee IEEE International Conference on Intelligent Engineering Systems (INES), JUN 30-JUL 02, 2016, Budapest, HUNGARY, ISSN: 1562-5850, ISBN: 978-1-5090-1216-9, Published: 2016;
364. Vasar, C., Prostean, O., Prostean, G. Evaluating solar radiation on a tilted surfaces - a study case in Timis (Romania), INTERNATIONAL CONFERENCE ON APPLIED SCIENCES 2015 (ICAS2015), Book Series: IOP Conference Series-Materials Science and Engineering, Volume: 106, Article Number: 012026, International Conference on Applied Sciences (ICAS), JUN 03-05, 2015, Military Econ Acad Wuhan, Wuhan, PEOPLES R CHINA, ISSN: 1757-8981, Published: 2016;
365. Vilceanu, C.B., Herban, S., Alionescu, A. Using Open Source GIS for the Management of the Administrative Territorial Unit, MODERN TECHNOLOGIES FOR THE 3RD MILLENNIUM, Pages: 73-78, 15th National Technical-Scientific Conference on Modern Technologies for the 3rd Millennium, NOV 27-28, 2015, Oradea, ROMANIA, ISBN: 978-88-7587-724-8, Published: 2016;
366. Vilceanu, R.C., Chiosa, N., Surianu, F.D. Study of the load variation for an electrical consumer, INTERNATIONAL CONFERENCE ON APPLIED SCIENCES 2015 (ICAS2015), Book Series: IOP Conference Series-Materials Science and Engineering, Volume: 106, Article Number: 012027, International Conference on Applied Sciences (ICAS), JUN 03-05, 2015, Military Econ Acad Wuhan, Wuhan, PEOPLES R CHINA, ISSN: 1757-8981, Published: 2016;
367. Vilceanu, R.C., Surianu, F.D. The Importance of Upgrading Power Stations with Numerical Protection Relays, PROCEEDINGS OF THE INTERNATIONAL CONFERENCE ON NUMERICAL ANALYSIS AND APPLIED MATHEMATICS 2015 (ICNAAM-2015), Book Series: AIP Conference Proceedings, Volume: 1738, Article Number: 080010, International Conference on Numerical Analysis and Applied Mathematics (ICNAAM), SEP 23-29, 2015, Rhodes, GREECE, ISSN: 0094-243X, ISBN: 978-0-7354-1392-4, Published: 2016;
368. Virag, I., Stoicu-Tivadar, L., Crisan-Vida, M. Gesture Interaction Browser-Based 3D Molecular Viewer, UNIFYING THE APPLICATIONS AND FOUNDATIONS OF BIOMEDICAL AND HEALTH INFORMATICS, Book Series: Studies in Health Technology and Informatics, Volume: 226, Pages: 17-20, 14th Annual International Conference on Informatics, Management, and Technology in Healthcare (ICIMTH), JUL 01-03, 2016, Athens, GREECE, ISSN: 0926-9630, ISBN: 978-1-61499-664-4; 978-1-61499-663-7, Published: 2016;
369. Virag, I., Stoicu-Tivadar, L., Crisan-Vida, M. Gesture-Based Interaction in Medical Interfaces, 2016 IEEE 11TH INTERNATIONAL SYMPOSIUM ON APPLIED COMPUTATIONAL INTELLIGENCE AND INFORMATICS (SACI), Pages: 519-523, 11th IEEE International Symposium on Applied Computational Intelligence and Informatics (SACI), MAY 12-14, 2016, Timisoara, ROMANIA, ISBN: 978-1-5090-2380-6, Published: 2016;
370. Visescu, M., Beilicci, E., Beilicci, R. Sediment Transport Modelling with Advanced Hydroinformatic Tool Case study - Modelling On Bega Channel Sector, WORLD MULTIDISCIPLINARY CIVIL ENGINEERING-ARCHITECTURE-URBAN PLANNING SYMPOSIUM 2016, WMCAUS 2016, Book Series: Procedia Engineering, Volume: 161, Pages: 1715-1721, World Multidisciplinary Civil Engineering-Architecture-Urban Planning Symposium (WMCAUS), JUN 13-17, 2016, Prague, CZECH REPUBLIC, ISSN: 1877-7058, Published: 2016;
371. Visescu, M., Stefanescu, C. THE MINIMAL IMPACT METHOD ON STORM WATER APPLIED IN A RESIDENTIAL AREA FROM TIMISOARA CITY, WATER, RESOURCES, FOREST, MARINE AND OCEAN ECOSYSTEMS CONFERENCE PROCEEDINGS, VOL I, Book Series: International Multidisciplinary Scientific GeoConference-SGEM, Pages: 743-750, 16th International Multidisciplinary Scientific Geoconference (SGEM 2016), JUN 30-JUL 06, 2016, Albena, BULGARIA, ISSN: 1314-2704, ISBN: 978-619-7105-61-2, Published: 2016;

372. Vlad, I., Herban, I.S., Stoian, M., Vilceanu, C.B. 3D Model Tools for Architecture and Archaeology Reconstruction, PROCEEDINGS OF THE INTERNATIONAL CONFERENCE ON NUMERICAL ANALYSIS AND APPLIED MATHEMATICS 2015 (ICNAAM-2015), Book Series: AIP Conference Proceedings, Volume: 1738, Article Number: 350005, International Conference on Numerical Analysis and Applied Mathematics (ICNAAM), SEP 23-29, 2015, Rhodes, GREECE, ISSN: 0094-243X, ISBN: 978-0-7354-1392-4, Published: 2016;
373. Vlasin, I., Chirila, C.B. ONLINE CONTEST BASED ON INTEGRATION OF ACTIVITIES, ADAPTABILITY AND STUDENTS COOPERATION USING ILIAS LMS, ELEARNING VISION 2020!, VOL III, Book Series: eLearning and Software for Education, Pages: 67-74, 12th International Scientific Conference on eLearning and Software for Education (eLSE), APR 21-22, 2016, Bucharest, ROMANIA, ISSN: 2066-026X, Published: 2016;
374. Voisan, E.I., Precup, R.E., Dragan, F. Facial Expression Recognition System Based on a Face Statistical Model and Support Vector Machines, 2016 IEEE 11TH INTERNATIONAL SYMPOSIUM ON APPLIED COMPUTATIONAL INTELLIGENCE AND INFORMATICS (SACI), Pages: 63-68, 11th IEEE International Symposium on Applied Computational Intelligence and Informatics (SACI), MAY 12-14, 2016, Timisoara, ROMANIA, ISBN: 978-1-5090-2380-6, Published: 2016;
375. Volker, S., Prostean, G. Research of Automotive Change Management and Combined Risk-Management Models, 13TH INTERNATIONAL SYMPOSIUM IN MANAGEMENT: MANAGEMENT DURING AND AFTER THE ECONOMIC CRISIS, Book Series: Procedia Social and Behavioral Sciences, Volume: 221, Pages: 395-404, 13th International Symposium in Management - Management During and after the Economic Crisis (SIM), OCT 09-10, 2015, Timisoara, ROMANIA, ISSN: 1877-0428, Published: 2016;
376. Zaharia, C., Gabor, A., Sinescu, C., Topala, F.I., Negrutiu, M.L., Levai, M.C., Duma, V.F., Bradu, A., Podoleanu, A.G. OCT and shear-force evaluations of Zirconia Fixed Partial Prosthesis processed with a conventional CAD/CAM technology, HIGH-END MEDICINE BASED ON LASER AND BIOTECHNOLOGIES Book Series: Proceedings of SPIE Volume: 9670 Article Number: UNSP 967010, 5th Congress of the World-Federation-for-Laser-Dentistry / 6th International Conference on Lasers in Medicine, MAY 07-09, 2015, Bucharest, ROMANIA, ISSN: 0277-786X, ISBN: 978-1-62841-893-4, Published: 2016.

BOOKS

EVOLUTION OF BOOKS UNDER AFFILIATIONS OF PUT 2013 - 2016

A published book is indisputable evidence of research that has been performed, completed, and accepted by peers. Book is also an indicator of achievement of a certain academic standard. Besides communication of a finalised piece of research, the book is the basis for further opinions, views and critiques from fellow professionals and academics separated by time and distance. Most importantly, it represents the only permanent record of scientific work that has been completed.

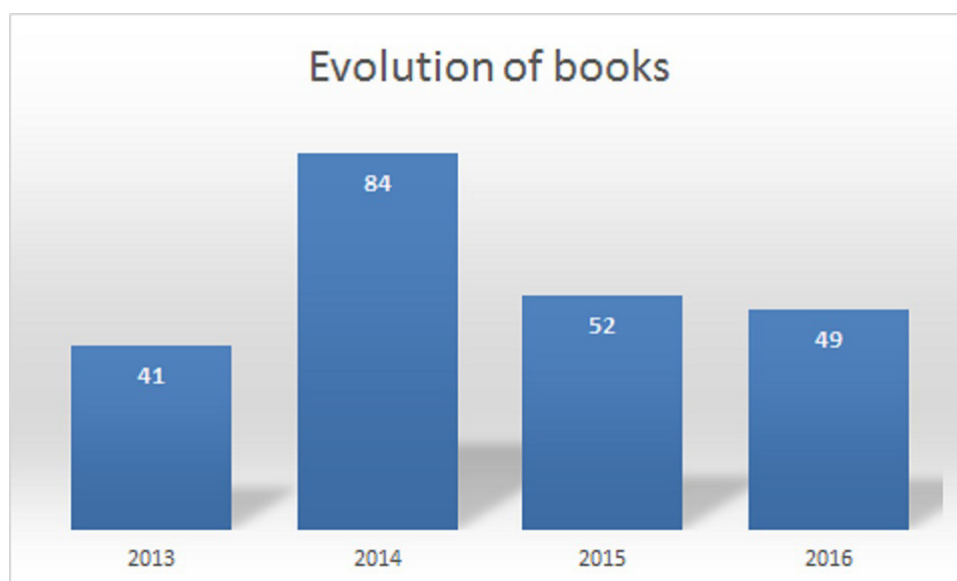

In this chapter we present the books written by our professors and researchers, published at Romanian publishers and as well as at international prestigious publishers.

Books in highlight

SOLAR HEATING AND COOLING SYSTEMS: FUNDAMENTALS, EXPERIMENTS AND APPLICATIONS

Ioan SÂRBU, Călin SEBARCHIEVICI

ELSEVIER, 2016, 442 p.

ISBN 978-0-12-811662-3

DOI: 10.1016/B978-0-12-811662-3.00001-3

Short description of the context

This book published in 2016 by the famous Elsevier Ltd. provides a comprehensive coverage of emerging solar technologies and applications from a high scientific and technical level, based on original research and the synthesis of consistent bibliographic material to meet the increasing need for modernization and for greater energy efficiency to significantly reduce CO₂ emissions..

Purpose and Motivation of the book

The book mainly presents a comprehensive overview of all major solar energy technologies together with fundamentals, experiments, and applications of solar heating and cooling systems. Technical, economic, and energy saving aspects related to design, modelling, and operation of these systems are also explored. This reference includes physical and mathematical concepts developed to make this publication a self-contained and up-to-date source of information for engineers, researchers, and professionals interested in the use of solar energy as an alternative energy source.

Summary

The book is structured into nine chapters.

- Chapter 1 summarises a description of renewable energy sources covering some general aspects of regional policies and presents the necessity for using solar energy in heating/cooling of buildings and domestic hot-water (DHW) production.
- Chapter 2 presents the main characteristics of solar energy and exposes a methodology for calculating and predicting solar radiation including the main computation elements and the estimation of solar radiation on tilted surface likely to be available as input to a solar device or crop at a specific location, orientation and time
- Chapter 3 provides a detailed description of energy balance for solar collector and of different types of solar thermal and photovoltaic (PV) collectors including the calculation of their efficiency and new materials for PV cells.
- Chapter 4 is focused on the analysis of thermal energy storage technologies that provide a way of valorising solar heat and reducing the energy demand of buildings.

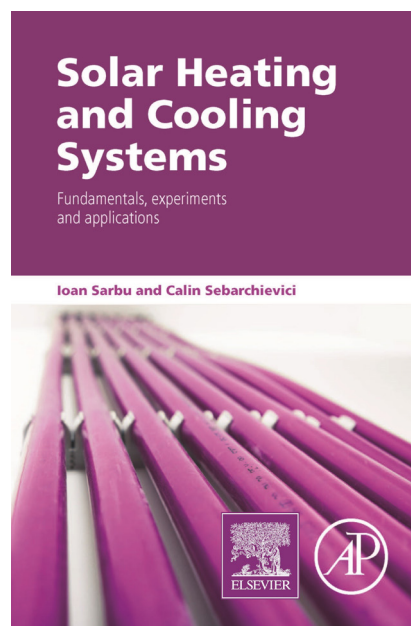

- Chapter 5 provides a description of main types of solar space and water heating systems and is also focused on active and combisystems. The f-chart method applicable to evaluate space and water heating in many climates and conditions and Transient System Simulation (TRNSYS) program is briefly described.
- Chapter 6 present the heat distribution systems in buildings, including hot-water radiators, radiant panels (floor, wall, ceiling and floor–ceiling) and room air heaters.
- Chapter 7 provides a detailed review of different solar thermal-driven refrigeration and cooling systems. Theoretical basis and practical applications for cooling systems within various working fluids assisted by solar energy and their recent advances are presented.
- Chapter 8 covers solar electric cooling systems including the solar PV and thermoelectric systems.
- Chapter 9 presents the operation principle of a heat pump (HP), discusses the vapour compression-based HP systems, and describes the thermodynamic cycle and they calculation, as well as operation regimes of a vapour-compression HP with electro-compressor.

This book provides a useful source of information and basis for extended research for all those involved in the field, whether as a graduate student, MSc student and also PhD student, academic, scientific researcher, industrialist, consultant, or government agency with responsibility in the area of solar energy.

LANGUAGE IN THE DIGITAL ERA: CHALLENGES AND PERSPECTIVES

Daniel DEJICA, Gyde HANSEN, Peter SANDRINI, Iulia PARA

Published by De Gruyter Open Ltd, Warsaw/Berlin

Part of Walter de Gruyter GmbH, Berlin/Boston, 2016, 246p.

ISBN: 978-3-11-047204-2, e-ISBN: 978-3-11-047205-9

DOI: <https://doi.org/10.1515/9783110472059>

Short description of the context

Edited by Daniel Dejica (Politehnica University of Timișoara), Gyde Hansen (Copenhagen Business School), Peter Sandrini (University of Innsbruck) and Iulia Para (University of the West, Timișoara) and published by De Gruyter, this collected volume pinpoints the impact of new technologies on languages and communication, highlights the evolution and changes undergone by humanities in conjunction with technological innovation, and looks at the way the language industry has adapted itself to the challenges of today's digitized world.

Purpose and Motivation of the book

The need for cooperation in such areas as industry, transportations, communications, or entertainment, the ever-growing increase in international trade, the enlargement and proliferation of international institutions, the need to keep up with the latest advances in all branches of science and technology, the linguistic consequences of the EU enlargement and the Digital Agenda for Europe are only some of the situations which account for the need to investigate the evolution of language in a globally digitized world. To address the needs of research in this ever-growing and ever-changing context, the editors brought together the contributions of several humanities scholars from Romania and abroad, who focus on the evolution of language in the digital era. The eighteen contributions are divided into three thematic parts, which explore general aspects of humanities and linguistics in the digital environment, the evolution of language and translation in today's digitized society, and the changes, challenges and perspectives of language teaching and learning in the age of technology.

Summary

The Introduction of the book is signed by the editors; it includes a rationale, a description of the book (a summary based on the abstracts provided by each contributor) and a section of notes on contributors.

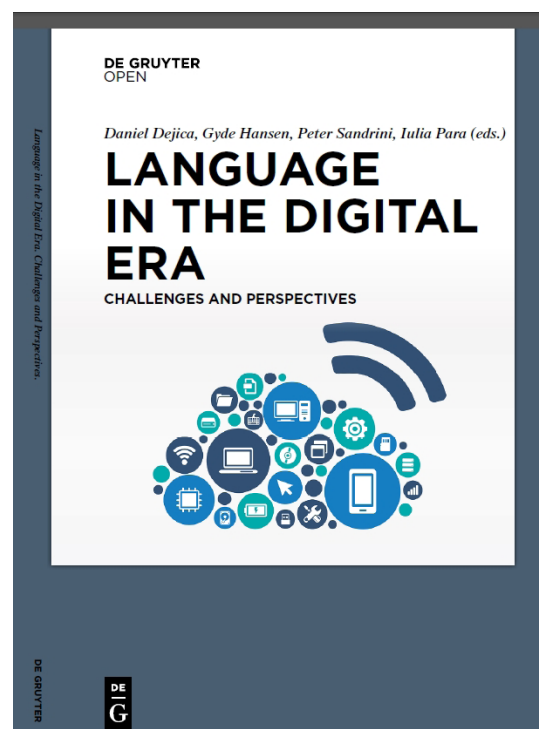

Part 1, *Humanities Gone Digital*, includes four chapters and explores general aspects of humanities and linguistics in the digital environment.

Part 2, *Language and Translation: From Pen and Paper to the Electronic Environment*, consists of eight contributions, which focus on a more specific branch of Philology, namely translation. The topics discussed include, but are not limited to the impact of new technologies on specialised translation, online resources for terminology management, translation of online advertising, subtitling, etc.

Part 3, *Language Teaching and Learning in the Age of Technology*, includes six chapters on language teaching and learning and will address the changes, challenges and perspectives of didactics in the age of technology.

Each contribution is divided into several sections that present the state of the art and the methodology used, and discuss the results and perspectives of the authors. The book is recommended to scholars, professionals, students and anyone interested in the changes within the humanities in conjunction with technological innovation or in the ways language is adapting to the challenges of today's digitized world.

Books List

1. Baci, I., Cunțan, C.D. Regimul armonic în tracțiunea electrică feroviară, Editura Politehnică, Timișoara, 2016, ISBN 978-606-35-0044-2;
2. Bancea, O., Adam, M. Instalații de ventilare și climatizare. Bazele de calcul, Editura Politehnică, Timișoara, 2016, ISBN 978-606-35-0043-5;
3. Bistran, D.A., Lemle, L.D. Culegere de probleme de ecuații diferențiale, Editura Politehnică, Timișoara, 2016, ISBN 978-606-35-0059-6;
4. Boncalo, O., Amăricăi, A. Logică digitală. Aplicații, Editura Politehnică, Timișoara, 2016, ISBN 978-606-554-581-6;
5. Carțiș, I. G., Udrescu, L. Procesarea termică a produselor metalice, Editura Politehnică, Timișoara, 2016, ISBN 978-606-35-0042-8;
6. Cădariu, L., Ene, R.D., Manolescu, L. Matematici asistate de calculator, Editura Politehnică, Timișoara, 2016, ISBN 978-606-35-0075-6;
7. Călinoiu, D.G., Trif-Tordai, G. Fizica în experimente, Editura Politehnică, Timișoara, 2016, ISBN 978-606-35-0039-8;
8. Chirilă, D., Ionescu, D. Lucrări practice. Jogging, Editura Politehnică, Timișoara, 2016, ISBN 978-606-35-0082-4;
9. Ciopec, A., Mirea, M. Practical works in soil mechanics, Editura Politehnică, Timișoara, 2016, ISBN 978-606-35-0056-5;
10. Ciopec, M., Negrea, A. Protecția mediului. Lucrări practice, Editura Politehnică, Timișoara, 2016, ISBN 978-973-625-964-7;
11. Ciurdariu, L. Algebră și geometrie, Editura Politehnică, Timișoara, 2016, ISBN 978-606-35-0078-7;
12. Codrean, C., Uțu, I.D., Buzdugan, D., Șerban, V.A. Materiale metalice avansate. Aplicații practice, Editura Politehnică, Timișoara, 2016, ISBN 978-606-554-843-5;
13. Cornut, A. Schițe de viață trăită, Editura Politehnică, Timișoara, 2016, ISBN 978-606-35-0093-0;
14. Costescu, C. Terasamente, Editura Politehnică, Timișoara, 2016, ISBN 978-606-35-0104-3;
15. De Sabata, C. Université Politehnică Timișoara : personnalités, visions, événements, Editura Politehnică, Timișoara, 2016, ISBN 978-606-35-0095-4;
16. Deaconu, S. Mașini electrice, Editura Politehnică, Timișoara, 2016, ISBN 978-606-35-0079-4;
17. Dejica, D., Hansen, G., Sandrini, P., Para, I. Language in the Digital Era. Challenges and Perspectives, De Gruyter Open Ltd, Warsaw/Berlin Part of Walter de Gruyter GmbH, Berlin/Boston, 2016, ISBN: 978-3-11-047204-2, e-ISBN: 978-3-11-047205-9;
18. Dumitrescu, C. Disertații 2015 - 2016, Editura Politehnică, Timișoara, 2016, ISBN 978-606-35-0083-1;
19. Dumitrescu, C., Povian, C.M. Cubul magic, Ed. a IV-a, Editura Politehnică, Timișoara, 2016, ISBN 978-606-35-0071-8;
20. Dumitrescu, C., Szitar, M., Povian, C., Giurea, D., Popov, M., Mohora, I. Culegere de probleme și aplicații de geometrie descriptivă, Ed. a IV-a, Editura Politehnică, Timișoara, 2016, ISBN 978-606-35-0069-5;

21. Eleş, G., Popescu, D., Pişleagă, M. Topografie. Ghid pentru lucrări de laborator și practică topografică, Editura Politehnica, Timișoara, 2016, ISBN 978-606-35-0097-8;
22. Floruț, S.C., Dan, D., Tănasă, C.M. Building Physics. Experimental work and analytical examples, Editura Politehnica, Timișoara, 2016, ISBN 978-606-35-0063-3;
23. Galeriu, C.D. Mecanica fluidelor newtoniene vâscoase incorporabile, Editura Politehnica, Timișoara, 2016, ISBN 978-606-35-0046-6;
24. Gherman, P.L. Tehnici de măsură și analiză a calității energiei electrice. Aplicații, Editura Politehnica, Timișoara, 2016, ISBN 978-606-35-0070-1;
25. Gontean, A. Programarea microcontrolerelor PIC în limbajul C. Aplicații, Editura Politehnica, Timișoara, 2016, ISBN 978-606-35-0053-4;
26. Herban, S. Ridicări topografice speciale și aplicații ale măsurătorilor inginerești. Manual universitar, Editura Politehnica, Timișoara, 2016, ISBN 978-606-35-0085-5;
27. Ionel, S. Școală și spirit, Editura Politehnica, Timișoara, 2016, ISBN 978-606-35-0073-2;
28. Jian, I. Baze de date, Editura Politehnica, Timișoara, 2016, ISBN 978-606-35-0066-5;
29. Lemle, L.D. Elemente de geometrie analitică și diferențială, Editura Politehnica, Timișoara, 2016, ISBN 978-606-35-0118-0;
30. Mirea, M., Ciopec, A. Lucrări practice în mecanica pământurilor, Editura Politehnica, Timișoara, 2016, ISBN 978-606-35-0057-2;
31. Murvay, P.S., Gurban, H.E., Groza, B. A practical introduction to microcontroller programming with S12, Editura Politehnica, Timișoara, 2016, ISBN 978-606-35-0094-7;
32. Nafoarniță, C., Isar, A. Signals and Systems. Vol. II, Editura Politehnica, Timișoara, 2016, ISBN 978-973-625-942-5, ISBN 978-606-35-0072-5 Vol. II;
33. Nenu, G.I. Modele de teste de matematică pentru Evaluarea Națională, Editura Politehnica, Timișoara, 2016, ISBN 978-606-35-0077-0;
34. Nițu, S.V. Procese tehnologice chimice, Editura Politehnica, Timișoara, 2016, ISBN 978-606-35-0081-7;
35. Păunescu, D., Hedrea, C. Calcul diferențial multidimensional, Editura Politehnica, Timișoara, 2016, ISBN 978-606-35-0023-7;
36. Pop, N., Păcurar, A. Fizică generală. În aplicații practice, Editura Politehnica, Timișoara, 2016, ISBN 978-606-35-0041-1;
37. Quint, F., Alexa, F., Pazstika, R. Proceedings of PROKATIM. Digital Signals Processing Applications, Editura Politehnica, Timișoara, 2016, ISBN 978-606-35-0096-1;
38. Rob, R., Pănoiu, C. Proiectarea și construcția filtrelor de armonici pentru instalații electrotermice de călire prin inducție, Editura Politehnica, Timișoara, 2016, ISBN 978-606-35-0055-8;
39. Sarbu, I., Sebarchievici, C. Solar Heating and Cooling Systems: Fundamentals, experiments and applications, Elsevier, 2016, ISBN 978-0-12-811662-3;
40. Sârbu, I., Sebarchievici, C. Valorificarea energiilor regenerabile, Editura Politehnica, Timișoara, 2016, ISBN 978-606-35-0076-3;

41. Stângaciu, V., Stângaciu, C.S. Digital Telecommunication, Signal Acquisition and Processing. Project and Practical Applications, Editura Politehnica, Timișoara, 2016, ISBN 978-606-35-0080-0;
42. Stoian, F.D. Termotehnica, Editura Politehnica, Timișoara, 2016, ISBN 978-606-35-0091-6;
43. Stoian, V., Dan, D., Dan, S., Bob, C., Pescari, S. Simpozion "Soluții sustenabile pentru proiectarea/execuția și reabilitarea construcțiilor", Editura Politehnica, Timișoara, 2016, ISBN 978-606-35-0030-5;
44. Szabo, R. Software Development. Applications, Editura Politehnica, Timișoara, 2016, ISBN 978-606-35-0058-9;
45. Ștefănescu, M., Ștefănescu, O.E. Chimie analitică instrumentală. Principii. Aplicații. Experimente. Vol. I, Editura Politehnica, Timișoara, 2016, ISBN 978-606-35-0004-6, ISBN 978-606-35-0005-3 vol. I;
46. Tokar, A. Instalații sanitare și de gaze. Vol. I, Editura Politehnica, Timișoara, 2016, ISBN 978-606-35-0086-2, ISBN 978-606-35-0087-9 Vol. I;
47. Tokar, A., Tokar, D. Instalații de alimentare cu gaze naturale combustibile a consumatorilor din clădiri. Ghid de proiectare, Editura Politehnica, Timișoara, 2016, ISBN 978-606-35-0088-6;
48. Vasiu, R., Andone, D., Evans, D. Centrul multimedia-primii douăzeci de ani/Multimedia Center-the first twenty years, Editura Politehnica, Timișoara, 2016, ISBN 978-606-35-0065-7;
49. Zăbavă, E.S. Proiectarea tehnică asistată de calculator, Editura Politehnica, Timișoara, 2016, ISBN 978-606-35-0003-9;

Book Chapters List

1. Boldea, I. Electric Energy and Electric Generators, SYNCHRONOUS GENERATORS, 2ND EDITION, Pages: 1-12, ISBN: 978-1-4987-2355-8; 978-1-4987-2356-5, 2016;
2. Boldea, I. Principles of Electric Generators, SYNCHRONOUS GENERATORS, 2ND EDITION, Pages: 13-69, ISBN: 978-1-4987-2355-8; 978-1-4987-2356-5, 2016;
3. Boldea, I. Prime Movers, SYNCHRONOUS GENERATORS, 2ND EDITION, Pages: 71-124, ISBN: 978-1-4987-2355-8; 978-1-4987-2356-5, 2016;
4. Boldea, I. Large- and Medium-Power Synchronous Generators: Topologies and Steady State, SYNCHRONOUS GENERATORS, 2ND EDITION, Pages: 125-186, ISBN: 978-1-4987-2355-8; 978-1-4987-2356-5, 2016;
5. Boldea, I. Synchronous Generators: Modeling for Transients, SYNCHRONOUS GENERATORS, 2ND EDITION, Pages: 187-256, ISBN: 978-1-4987-2355-8; 978-1-4987-2356-5, 2016;
6. Boldea, I. Control of Synchronous Generators in Power Systems, SYNCHRONOUS GENERATORS, 2ND EDITION, Pages: 257-311, ISBN: 978-1-4987-2355-8; 978-1-4987-2356-5, 2016;
7. Boldea, I. Design of Synchronous Generators, SYNCHRONOUS GENERATORS, 2ND EDITION, Pages: 313-403, ISBN: 978-1-4987-2355-8; 978-1-4987-2356-5, 2016;
8. Boldea, I. Testing of Synchronous Generators, SYNCHRONOUS GENERATORS, 2ND EDITION, Pages: 405-464, ISBN: 978-1-4987-2355-8; 978-1-4987-2356-5, 2016;
9. Boldea, I. Wound-Rotor Induction Generators: Steady State, VARIABLE SPEED GENERATORS, 2ND EDITION, Pages: 1-35, ISBN: 978-1-4987-2358-9; 978-1-4987-2357-2, 2016;
10. Boldea, I. Wound-Rotor Induction Generators: Transients and Control, VARIABLE SPEED GENERATORS, 2ND EDITION, Pages: 37-94, ISBN: 978-1-4987-2358-9; 978-1-4987-2357-2, 2016;
11. Boldea, I. Wound-Rotor Induction Generators: Design and Testing, VARIABLE SPEED GENERATORS, 2ND EDITION, Pages: 95-117, ISBN: 978-1-4987-2358-9; 978-1-4987-2357-2, 2016;
12. Boldea, I. Self-Excited Induction Generators, VARIABLE SPEED GENERATORS, 2ND EDITION, Pages: 119-163, ISBN: 978-1-4987-2358-9; 978-1-4987-2357-2, 2016;
13. Boldea, I. Stator-Converter-Controlled Induction Generators, VARIABLE SPEED GENERATORS, 2ND EDITION, Pages: 165-193, ISBN: 978-1-4987-2358-9; 978-1-4987-2357-2, 2016;
14. Boldea, I. Automotive Claw-Pole-Rotor Generator Systems, VARIABLE SPEED GENERATORS, 2ND EDITION, Pages: 195-244, ISBN: 978-1-4987-2358-9; 978-1-4987-2357-2, 2016;
15. Boldea, I. Induction Starter/Alternators for Electric Hybrid Vehicles, VARIABLE SPEED GENERATORS, 2ND EDITION, Pages: 245-277, ISBN: 978-1-4987-2358-9; 978-1-4987-2357-2, 2016;
16. Boldea, I. Permanent-Magnet-Assisted Reluctance Synchronous Starter/Alternators for Electric Hybrid Vehicles, VARIABLE SPEED GENERATORS, 2ND EDITION, Pages: 279-337, ISBN: 978-1-4987-2358-9; 978-1-4987-2357-2, 2016;
17. Boldea, I. Switched Reluctance Generators and Their Control, VARIABLE SPEED GENERATORS, 2ND EDITION, Pages: 339-375, ISBN: 978-1-4987-2358-9; 978-1-4987-2357-2, 2016;
18. Boldea, I. Permanent Magnet Synchronous Generator Systems, VARIABLE SPEED GENERATORS, 2ND EDITION, Pages: 377-477, ISBN: 978-1-4987-2358-9; 978-1-4987-2357-2, 2016;
19. Boldea, I. Transverse Flux and Flux Reversal Permanent Magnet Generator Systems, VARIABLE SPEED GENERATORS, 2ND EDITION, Pages: 479-527, ISBN: 978-1-4987-2358-9; 978-1-4987-2357-2, 2016;
20. Boldea, I. Linear Motion Alternators, VARIABLE SPEED GENERATORS, 2ND EDITION, Pages: 529-568, ISBN: 978-1-4987-2358-9; 978-1-4987-2357-2, 2016;

21. Gavruta, L., Gavruta, P. Approximation of Functions by Additive and by Quadratic Mappings, MATHEMATICAL ANALYSIS, APPROXIMATION THEORY AND THEIR APPLICATIONS, Book Series: Springer Optimization and Its Applications, Volume: 111, Pages: 281-292, ISSN: 1931-6828, ISBN: 978-3-319-31281-1; 978-3-319-31279-8, 2016;
22. Sadowski, T., Marsavina, L., Craciun, E.M. On the Problem of Cracking in 2-Phase Ceramic Matrix Composite Materials, ADVANCED METHODS OF CONTINUUM MECHANICS FOR MATERIALS AND STRUCTURES, Book Series: Advanced Structured Materials, Volume: 60, Pages: 367-378, ISSN: 1869-8433, ISBN: 978-981-10-0959-4; 978-981-10-0958-7, 2016;
23. Sarbu, I., Adam, M. Advances in Energy Research, vol. 23, Cap. 5: Investigation of the energy efficiency of conventional air conditioning systems in office buildings, Nova Science Publisher, 2016, ISBN 978-1-63484-836-7;
24. Sarbu, I., Sebarchievici, C. Advances in Geothermal Energy, Cap. 1: Using ground-source heat pump systems for heating/cooling of buildings, InTech, 2016, ISBN 978-953-51-2241-8;
25. Sarbu, I., Sebarchievici, C. Renewable Energy: Sources, Applications and Emerging Technologies, Cap. 6: Solar-assisted heat pump systems, Nova Science Publisher, 2016, ISBN 978-1-63485-651-5.



Politehnica University of Timisoara



Piata Victoriei No. 2
RO 300006, Timisoara
Tel: +40 256 40 30 00
Fax: +40 256 40 30 21
Email: rector@upt.ro
www.upt.ro



EDITURA POLITEHNICA

ISSN 1841-2769